

**FOREIGN AND MILITARY
INTELLIGENCE**

BOOK I

FINAL REPORT
OF THE
SELECT COMMITTEE
TO STUDY GOVERNMENTAL OPERATIONS
WITH RESPECT TO
INTELLIGENCE ACTIVITIES
UNITED STATES SENATE
TOGETHER WITH
ADDITIONAL, SUPPLEMENTAL, AND SEPARATE
VIEWS



APRIL 26 (legislative day, APRIL 14), 1976

U.S. GOVERNMENT PRINTING OFFICE
WASHINGTON : 1976

69-983 O

**SENATE SELECT COMMITTEE TO STUDY GOVERNMENTAL OPERATIONS
WITH RESPECT TO INTELLIGENCE ACTIVITIES**

FRANK CHURCH, Idaho, *Chairman*

JOHN G. TOWER, Texas, *Vice Chairman*

PHILIP A. HART, Michigan

WALTER F. MONDALE, Minnesota

WALTER D. HUDDLESTON, Kentucky

ROBERT MORGAN, North Carolina

GARY HART, Colorado

HOWARD H. BAKER, Jr., Tennessee

BARRY GOLDWATER, Arizona

CHARLES McC. MATHIAS, Jr., Maryland

RICHARD S. SCHWEIKER, Pennsylvania

WILLIAM G. MILLER, *Staff Director*

FREDERICK A. O. SCHWAB, Jr., *Chief Counsel*

CURTIS P. SMOTHERS, *Counsel to the Minority*

AUDREY HATRY, *Clerk of the Committee*

(II)

LETTER OF TRANSMITTAL

(By Senator Frank Church, Chairman of the Senate Select Committee to Study Governmental Operations With Respect to Intelligence Activities)

On January 27, 1975, the Senate established a Select Committee to conduct an investigation and study of the intelligence activities of the United States. After 15 months of intensive work, I am pleased to submit to the Senate this volume of the Final Report of the Committee relating to foreign and military intelligence. The inquiry arises out of allegations of abuse and improper activities by the intelligence agencies of the United States, and great public concern that the Congress take action to bring the intelligence agencies under the constitutional framework.

The members of the Select Committee have worked diligently and in remarkable harmony. I want to express my gratitude to the Vice Chairman, Senator John Tower of Texas, for his cooperation throughout and the able assistance he has given me in directing this most difficult task. While every member of the Committee has made important contributions, I especially want to thank Senator Walter D. Huddleston of Kentucky for the work he has done as Chairman of the Foreign and Military Subcommittee. His direction of the Subcommittee, working with Senator Charles McC. Mathias of Maryland, Senator Gary Hart of Colorado and Senator Barry Goldwater of Arizona, has been of immeasurable help to me in bringing this enormous undertaking to a useful and responsible conclusion.

Finally, I wish to thank the staff for the great service they have performed for the Committee and for the Senate in assisting the members of the Committee to carry out the mandate levied by Senate Resolution 21. The quality, integrity and devotion of the staff has contributed in a significant way to the important analyses, findings and recommendations of the Committee.

The volume which follows, the *Report on the Foreign and Military Intelligence Activities of the United States*, is intended to provide to the Senate the basic information about the intelligence agencies of the United States required to make the necessary judgments concerning the role such agencies should play in the future. Despite security considerations which have limited what can responsibly be printed for public release the information which is presented in this report is a reasonably complete picture of the intelligence activities undertaken by the United States, and the problems that such activities pose for constitutional government.

The Findings and Recommendations contained at the end of this volume constitute an agenda for action which, if adopted, would go a long way toward preventing the abuses that have occurred in the past from occurring again, and would assure that the intelligence activities of the United States will be conducted in accordance with constitutional processes.

FRANK CHURCH.

NOTE

The Committee's Final Report has been reviewed and declassified by the appropriate executive agencies. These agencies submitted comments to the Committee on security and factual aspects of each chapter. On the basis of these comments, the Committee and staff conferred with representatives of the agencies to determine which parts of the report should remain classified to protect sensitive intelligence sources and methods.

At the request of the agencies, the Committee deleted three chapters from this report: "Cover," "Espionage," and "Budgetary Oversight." In addition, two sections of the chapter "Covert Action of the CIA" and one section of the chapter "Department of State" have been deleted at the request of the agencies. Particular passages which were changed at the request of the agencies are denoted by italics and a footnote. Complete versions of deleted or abridged materials are available to Members of the Senate in the Committee's classified report under the provisions of S. Res. 21 and the Standing Rules of the Senate.

Names of individuals were deleted when, in the Committee's judgment, disclosure of their identities would either endanger their safety or constitute a substantial invasion of privacy. Consequently, footnote citations to testimony and documents occasionally contain only descriptions of an individual's position.

Appendix Three, "Soviet Intelligence Collection and Intelligence Against the United States," is derived solely from a classified CIA report on the same subject which was edited for security considerations by the Select Committee staff.

CONTENTS

	Page
I. INTRODUCTION.....	1
A. The Mandate of the Committee's Inquiry.....	2
B. The Purpose of the Committee's Findings and Recommendations.....	4
C. The Focus and Scope of the Committee's Inquiry and Obstacles Encountered.....	5
D. The Historical Context of the Inquiry.....	8
E. The Dilemma of Secrecy and Open Constitutional Government.....	11
II. THE FOREIGN AND MILITARY INTELLIGENCE OPERATIONS OF THE UNITED STATES: AN OVERVIEW.....	15
A. The Basic Issues: Secrecy and Democracy.....	16
B. The Scope of the Select Committee Inquiry into Foreign and Military Intelligence Operations.....	17
C. The Intelligence Process: Theory and Reality.....	17
D. Evolution of the United States Intelligence Community.....	19
E. The Origins of the Postwar Intelligence Community.....	20
F. The Response to the Soviet Threat.....	22
G. Korea: The Turning Point.....	23
H. The "Protracted Conflict".....	24
I. Third World Competition and Nuclear Crisis.....	25
J. Technology and Tragedy.....	26
K. The 1970s.....	27
L. The Task Ahead.....	28
III. THE CONSTITUTIONAL FRAMEWORK FOR INTELLIGENCE ACTIVITIES.....	31
A. The Joint Responsibilities of the Legislative and Executive Branches—Separation of Powers and Checks and Balances.....	31
B. The Historical Practice.....	33
C. The Constitutional Power of Congress to Regulate the Conduct of Foreign Intelligence Activity.....	38
IV. THE PRESIDENT'S OFFICE.....	41
A. The National Security Council.....	42
B. Authorization and Control of Covert Activities.....	48
C. Providing the Intelligence Required by Policymakers.....	61
D. Advising the President on Intelligence Issues.....	62
E. Allocating Intelligence Resources.....	65
V. THE DIRECTOR OF CENTRAL INTELLIGENCE.....	71
A. The Producer of National Intelligence.....	73
B. Coordinator of Intelligence Activities.....	83
C. Director of the CIA.....	94
VI. HISTORY OF THE CENTRAL INTELLIGENCE AGENCY.....	97
A. The Central Intelligence Group and the Central Intelligence Agency: 1946-1952.....	99
B. The Dulles Era: 1953-1961.....	109
C. Change and Routinization: 1961-1970.....	115
D. The Recent Past: 1971-1975.....	121
E. Conclusion.....	124
VII. THE CENTRAL INTELLIGENCE AGENCY: STATUTORY AUTHORITY.....	127
A. Clandestine Collection of Intelligence.....	128
B. Covert Action.....	131
C. Domestic Activities.....	135

	Page
VIII. COVERT ACTION.....	141
A. Evolution of Covert Action.....	143
B. Congressional Oversight.....	149
C. Findings and Conclusions.....	152
IX. COUNTERINTELLIGENCE.....	163
A. Counterintelligence: An Introduction.....	163
B. Current Issues in Counterintelligence.....	171
C. Conclusions.....	177
X. THE DOMESTIC IMPACT OF FOREIGN CLANDESTINE OPERATIONS: THE CIA AND ACADEMIC INSTITUTIONS, THE MEDIA, AND RELIGIOUS INSTITUTIONS.....	179
A. Covert Use of Academic and Voluntary Organizations.....	181
B. Covert Relationships with the United States Media.....	191
C. Covert Use of U.S. Religious Groups.....	201
XI. PROPRIETARIES.....	205
A. Overview.....	206
B. Structure.....	207
C. Operation of Proprietaries.....	234
D. The Disposal of Proprietaries.....	236
E. Financial Aspects.....	247
F. Some General Considerations.....	251
XII. CIA PRODUCTION OF FINISHED INTELLIGENCE.....	257
A. Evolution of the CIA's Intelligence Directorate.....	259
B. The Intelligence Directorate Today.....	265
C. The Relationship Between Intelligence and Policy.....	266
D. The Limits of Intelligence.....	268
E. The Personnel System.....	269
F. Recruitment and Training of Analysts.....	270
G. The Intelligence Culture and Analytical Bias.....	270
H. The Nature of the Production Process: Consensus Versus Competition.....	271
I. The "Current Events" Syndrome.....	272
J. Innovation.....	273
K. Overload on Analysts and Consumers.....	274
L. Quality Control.....	276
M. Consumer Guidance and Evaluation.....	276
N. The Congressional Role.....	277
XIII. THE CIA'S INTERNAL CONTROLS: THE INSPECTOR GEN- ERAL AND THE OFFICE OF GENERAL COUNSEL.....	279
A. The General Counsel.....	280
B. The Office of the Inspector General.....	289
C. Internal and External Review of the Office of the Inspector General.....	303
XIV. THE DEPARTMENT OF STATE.....	305
A. Origins of the State Department Intelligence Function.....	305
B. Command and Control.....	308
C. Support Communications.....	315
D. Production of Intelligence.....	515
XV. DEPARTMENT OF DEFENSE.....	319
A. Objectives and Organization of the Defense Intelligence Com- munity.....	320
B. The Defense Intelligence Budget.....	328
C. Management Problems of the Defense Intelligence Com- munity.....	341
D. Agencies and Activities of Special Interest.....	349
E. Military Counterintelligence and Investigative Agencies.....	355
F. Chemical and Biological Activities.....	359
G. Meeting Future Needs in Defense Intelligence.....	363

	Page
XVI. DISCLOSURE OF BUDGET INFORMATION ON THE INTELLIGENCE COMMUNITY	367
A. The Present Budgetary Process for Intelligence Community Agencies and Its Consequences.....	367
B. The Constitutional Requirement.....	369
C. Alternatives to Concealing Intelligence Budgets from Congress and the Public.....	374
D. The Effect Upon National Security of Varying Levels of Budget Disclosure.....	376
E. The Argument that Publication of Any Information will Inevitably Result in Demands for Further Information.....	381
F. The Argument that the United States Should Not Publish Information on Its Intelligence Budget Because No Other Government in the World Does.....	383
G. Summary and Conclusion.....	384
XVII. TESTING AND USE OF CHEMICAL AND BIOLOGICAL AGENTS BY THE INTELLIGENCE COMMUNITY	385
A. The Programs Investigated.....	387
B. CIA Drug Testing Programs.....	392
C. Covert Testing on Human Subjects by Military Intelligence Groups.....	411
D. Cooperation and Competition Among the Intelligence Agencies, and Between the Agencies and Other Individuals and Institutions.....	420
XVIII. SUMMARY: FINDINGS AND RECOMMENDATIONS	423
A. Introduction.....	423
B. General Findings.....	424
C. The 1947 National Security Act and Related Legislation.....	426
D. The National Security Council and the Office of the President.....	427
E. The Director of Central Intelligence.....	432
F. The Central Intelligence Agency.....	435
G. Reorganization of the Intelligence Community.....	449
H. CIA Relations with United States Institutions and Private Citizens.....	451
I. Proprietaries and Cover.....	456
J. Intelligence Liaison.....	459
K. The General Counsel and the Inspector General.....	459
L. The Department of Defense.....	462
M. The Department of State and Ambassadors.....	466
N. Oversight and the Intelligence Budget.....	469
O. Chemical and Biological Agents and the Intelligence Community.....	471
P. General Recommendations.....	472
APPENDIX I: Congressional Authorization for the Central Intelligence Agency to Conduct Covert Action	475
A. The National Security Act of 1947.....	476
B. The CIA Act of 1949.....	492
C. The Provision of Funds to the CIA by Congress.....	496
D. The Holtzman and Abouresk Amendments of 1974.....	502
E. The Hughes-Ryan Amendment.....	505
F. Conclusion.....	508
APPENDIX II: Additional Covert Action Recommendations	511
A. Statement of Clark M. Clifford.....	512
B. Statement of Cyrus Vance.....	516
C. Statement of David A. Phillips.....	518
D. Prepared Statement of Morton H. Halperin.....	520
E. Recommendations of the Harvard University Institute of Politics, Study Group on Intelligence Activities.....	524
F. Recommendations of the House Select Committee on Intelligence Concerning Covert Action.....	533
G. Article from Foreign Affairs by Harry Rositzke: America's Secret Operations: A Perspective.....	534
H. Article from Saturday Review by Tom Braden: What's Wrong with the CIA?.....	547
I. Recommendations of the Commission on the Organization of the Government for the Conduct of Foreign Policy (the Murphy Commission) Concerning Covert Action.....	554

VIII

APPENDIX III: Soviet Intelligence Collection and Operations Against the United States.....	Page 557
A. Introduction.....	557
B. Organization and Structure.....	558
C. The GRU.....	560
D. The Scope and Methods of Anti-United States Operations by the KGB and the GRU.....	561
E. Eastern European Security and Intelligence Services.....	561
ADDITIONAL VIEWS OF SENATOR FRANK CHURCH.....	563
ADDITIONAL VIEWS OF SENATORS WALTER F. MONDALE, GARY HART, AND PHILIP HART.....	567
INTRODUCTION TO SEPARATE VIEWS OF SENATORS JOHN G. TOWER, HOWARD H. BAKER, JR. AND BARRY M. GOLDWATER.....	571
SEPARATE VIEWS OF SENATOR JOHN G. TOWER.....	573
INDIVIDUAL VIEWS OF SENATOR BARRY GOLDWATER.....	577
SEPARATE VIEWS OF HOWARD H. BAKER, JR.....	594
SUPPLEMENTAL VIEWS OF SENATOR CHARLES McC. MATHIAS, JR.....	609
ADDITIONAL VIEWS OF SENATOR RICHARD S. SCHWEIKER.....	615
GLOSSARY OF SELECTED INTELLIGENCE TERMS AND LIST OF ABBREVIATIONS.....	617
NATIONAL INTELLIGENCE CHARTS.....	634
SENATE RESOLUTION 21.....	636
STAFF LIST.....	640

I. INTRODUCTION

The Senate Select Committee on Intelligence Activities has conducted a fifteen month long inquiry, the first major inquiry into intelligence since World War II. The inquiry arose out of allegations of substantial, even massive wrong-doing within the "national intelligence" system.¹ This final report provides a history of the evolution of intelligence, an evaluation of the intelligence system of the United States, a critique of its problems, recommendations for legislative action and recommendations to the executive branch. The Committee believes that its recommendations will provide a sound framework for conducting the vital intelligence activities of the United States in a manner which meets the nation's intelligence requirements and protects the liberties of American citizens and the freedoms which our Constitution guarantees.

The shortcomings of the intelligence system, the adverse effects of secrecy, and the failure of congressional oversight to assure adequate accountability for executive branch decisions concerning intelligence activities were major subjects of the Committee's inquiry. Equally important to the obligation to investigate allegations of abuse was the duty to review systematically the intelligence community's overall activities since 1945, and to evaluate its present structure and performance.

An extensive national intelligence system has been a vital part of the United States government since 1941. Intelligence information has had an important influence on the direction and development of American foreign policy and has been essential to the maintenance of our national security. The Committee is convinced that the United States requires an intelligence system which will provide policymakers with accurate intelligence and analysis. We must have an early warning system to monitor potential military threats by countries hostile to United States interests. We need a strong intelligence system to verify that treaties concerning arms limitation are being honored. Information derived from the intelligence agencies is a necessary ingredient in making national defense and foreign policy decisions. Such information is also necessary in countering the efforts of hostile intelligence services, and in halting terrorists, international drug traffickers and other international criminal activities. Within this country certain carefully controlled intelligence activities are essential for effective law enforcement.

The United States has devoted enormous resources to the creation of a national intelligence system, and today there is an awareness on the part of many citizens that a national intelligence system is a per-

¹ National intelligence includes but is not limited to the CIA, NSA, DIA, elements within the Department of Defense for the collection of intelligence through reconnaissance programs, the Intelligence Division of the FBI, and the intelligence elements of the State Department and the Treasury Department.

manent and necessary component of our government. The system's value to the country has been proven and it will be needed for the foreseeable future. But a major conclusion of this inquiry is that congressional oversight is necessary to assure that in the future our intelligence community functions effectively, within the framework of the Constitution.

The Committee is of the view that many of the unlawful actions taken by officials of the intelligence agencies were rationalized as their public duty. It was necessary for the Committee to understand how the pursuit of the public good could have the opposite effect. As Justice Brandeis observed:

Experience should teach us to be most on our guard to protect liberty when the Government's purposes are beneficent. Men born to freedom are naturally alert to repel invasion of their liberty by evil-minded rulers. The greatest dangers to liberty lurk in insidious encroachment by men of zeal, well-meaning but without understanding.²

A. THE MANDATE OF THE COMMITTEE'S INQUIRY

On January 27, 1975, Senate Resolution 21 established a select committee "to conduct an investigation and study of governmental operations with respect to intelligence activities and of the extent, if any, to which illegal, improper, or unethical activities were engaged in by any agency of the Federal Government." Senate Resolution 21 lists specific areas of inquiry and study:

(1) Whether the Central Intelligence Agency has conducted an illegal domestic intelligence operation in the United States.

(2) The conduct of domestic intelligence or counterintelligence operations against United States citizens by the Federal Bureau of Investigation or any other Federal agency.

(3) The origin and disposition of the so-called Huston Plan to apply United States intelligence agency capabilities against individuals or organizations within the United States.

(4) The extent to which the Federal Bureau of Investigation, the Central Intelligence Agency, and other Federal law enforcement or intelligence agencies coordinate their respective activities, any agreements which govern that coordination, and the extent to which a lack of coordination has contributed to activities or actions which are illegal, improper, inefficient, unethical, or contrary to the intent of Congress.

(5) The extent to which the operation of domestic intelligence or counterintelligence activities and the operation of any other activities within the United States by the Central Intelligence Agency conforms to the legislative charter of that Agency and the intent of the Congress.

(6) The past and present interpretation by the Director of Central Intelligence of the responsibility to protect intelligence sources and methods as it relates to that provision of the National Security Act of 1947 which provides "...

² *Olmstead v. United States*, 277 U.S. 436, 470 (1928).

that the agency shall have no police, subpoena, law enforcement powers, or internal security functions. . . ."³

(7) The nature and extent of executive branch oversight of all United States intelligence activities.

(8) The need for specific legislative authority to govern the operations of any intelligence agencies of the Federal Government now existing without that explicit statutory authority, including but not limited to agencies such as the Defense Intelligence Agency and the National Security Agency.

(9) The nature and extent to which Federal agencies cooperate and exchange intelligence information and the adequacy of any regulations or statutes which govern such cooperation and exchange of intelligence information.

(10) The extent to which United States intelligence agencies are governed by Executive Orders, rules, or regulations either published or secret and the extent to which those Executive Orders, rules, or regulations interpret, expand, or are in conflict with specific legislative authority.

(11) The violation or suspected violation of any State or Federal statute by any intelligence agency or by any person by or on behalf of any intelligence agency of the Federal Government including but not limited to surreptitious entries, surveillance, wiretaps, or eavesdropping, illegal opening of the United States mail, or the monitoring of the United States mail.

(12) The need for improved, strengthened, or consolidated oversight of United States intelligence activities by the Congress.

(13) Whether any of the existing laws of the United States are inadequate, either in their provisions or manner of enforcement, to safeguard the rights of American citizens, to improve executive and legislative control of intelligence and related activities, and to resolve uncertainties as to the authority of United States intelligence and related agencies.

(14) Whether there is unnecessary duplication of expenditure and effort in the collection and processing of intelligence information by United States agencies.

(15) The extent and necessity of overt and covert intelligence activities in the United States and abroad.

In addressing these mandated areas of inquiry, the Committee has focused on three broad questions:

1. Whether intelligence activities have functioned in accordance with the Constitution and the laws of the United States.

2. Whether the structure, programs, past history, and present policies of the American intelligence system have served the national interests in a manner consistent with declared national policies and purposes.

³ 50 U.S.C. 403(d)(8); Appendix B, Senate Select Committee Hearings (hereinafter cited as hearings), Vol 7, p. 210.

3. Whether the processes through which the intelligence agencies have been directed and controlled have been adequate to assure conformity with policy and the law.

Over the past year, the Committee and its staff have carefully examined the intelligence structure of the United States. Considerable time and effort have been devoted in order to understand what has been done by the United States Government in secrecy during the thirty-year period since the end of World War II. It is clear to the Committee that there are many necessary and proper governmental activities that must be conducted in secrecy. Some of these activities affect the security and the very existence of the nation.

It is also clear from the Committee's inquiry that intelligence activities conducted outside the framework of the Constitution and statutes can undermine the treasured values guaranteed in the Bill of Rights. Further, if the intelligence agencies act in ways inimical to declared national purposes, they damage the reputation, power, and influence of the United States abroad.

The Committee's investigation has documented that a number of actions committed in the name of "national security" were inconsistent with declared policy and the law. Hearings have been held and the Committee has issued reports on alleged assassination plots, covert action in Chile and the interception of domestic communications by the National Security Agency (NSA). Regrettably, some of these abuses cannot be regarded as aberrations.

B. THE PURPOSE OF THE COMMITTEE'S FINDINGS AND RECOMMENDATIONS

It is clear that a primary task for any successor oversight committee, and the Congress as a whole, will be to frame basic statutes necessary under the Constitution within which the intelligence agencies of the United States can function efficiently under clear guidelines. Charters delineating the missions, authorities, and limitations for some of the United States most important intelligence agencies do not exist. For example, there is no statutory authority for the NSA's intelligence activities. Where statutes do exist, as with the CIA, they are vague and have failed to provide the necessary guidelines defining missions and limitations.

The Committee's investigation has demonstrated, moreover, that the lack of legislation has had the effect of limiting public debate upon some important national issues.

The CIA's broad statutory charter, the 1947 National Security Act, makes no specific mention of covert action. The CIA's former General Counsel, Lawrence Houston, who was deeply involved in drafting the 1947 Act, wrote in September 1947, "we do not believe that there was any thought in the minds of Congress that the CIA under [the authority of the National Security Act] would take positive action for subversion and sabotage."⁴ Yet, a few months after enactment of the 1947 legislation, the National Security Council authorized the CIA to engage in covert action programs. The provision of the Act often cited as authorizing CIA covert activities provides for the Agency:

⁴ Memorandum from CIA General Counsel Lawrence Houston to DCI Hillenkoetter, 9/26/47.

... to perform such other functions and duties related to intelligence affecting the national security as the National Security Council may from time to time direct.¹⁴

Secret Executive Orders issued by the NSC to carry out covert action programs were not subject to congressional review. Indeed, until recent years, except for a few members, Congress was not fully aware of the existence of the so-called "secret charter for intelligence activities." Those members who did know had no institutional means for discussing their knowledge of secret intelligence activities with their colleagues. The problem of how the Congress can effectively use secret knowledge in its legislative processes remains to be resolved. It is the Committee's view that a strong and effective oversight committee is an essential first step that must be taken to resolve this fundamental issue.

C. THE FOCUS AND SCOPE OF THE COMMITTEE'S INQUIRY AND OBSTACLES ENCOUNTERED

The inquiry mandated in S. Res. 21 falls into two main categories. The first concerns allegations of wrong-doing. The nature of the Committee's inquiry into these matters tends, quite properly, to be akin to the investigations conducted by Senate and Congressional committees in the past. We decided from the outset, however, that this committee is neither a court, nor a law enforcement agency, and that while using many traditional congressional investigative techniques, our inquiry has served primarily to illustrate the problems before Congress and the country. The Justice Department and the courts in turn have their proper roles to play.

The second category of inquiry has been an examination of the intelligence agencies themselves. The Committee wished to learn enough about their past and present activities to make the legislative judgments required to assure the American people that whatever necessary secret intelligence activities were being undertaken were subject to constitutional processes and were being conducted in as effective, humane, and efficient a manner as possible.

The Committee focused on many issues affecting the intelligence agencies which had not been seriously addressed since our peacetime intelligence system was created in 1947. The most important questions relating to intelligence, such as its value to national security purposes and its cost and quality, have been carefully examined over the past year. Although some of the Committee's findings can be reported to the public only in outline, enough can be set forth to justify the recommendations. The Committee has necessarily been selective. A year was not enough time to investigate everything relevant to intelligence activities.

These considerations guided the Committee's choices:

- (1) A limited number of programs and incidents were examined in depth rather than reviewing hundreds superficially. The Committee's purpose was to understand the causes for the particular performance or behavior of an agency.
- (2) The specific cases examined were chosen because they reflected generic problems.

¹⁴ 50 U.S.C. 403(d) (5).

(3) Where broad programs were closely reviewed (for example, the CIA's covert action programs), the Committee sought to examine successes as well as apparent failures.

(4) Programs were examined from Franklin Roosevelt's administration to the present. This was done in order to present the historical context within which intelligence activities have developed and to assure that sensitive, fundamental issues would not be subject to possible partisan biases.

It is clear from the Committee's inquiry that problems arising from the use of the national intelligence system at home and abroad are to be found in every administration. Accordingly, the Committee chose to emphasize particular parts of the national intelligence system and to address particular cases in depth. The Committee has concentrated its energies on the six executive branch groups that make up what is called "National Intelligence".

- (1) The Central Intelligence Agency.
- (2) The counterintelligence activities of the Federal Bureau of Investigation.
- (3) The National Security Agency.
- (4) The national intelligence components of the Department of Defense other than NSA.
- (5) The National Security Council.
- (6) The intelligence activities of the Department of State.

The investigation of these national intelligence groupings included examining the degree of command and control exercised over them by the President and other key Government officials or institutions. The Committee also sought to evaluate the ability and effectiveness of Congress to assert its oversight right and responsibilities. The agencies the Committee has concentrated on have great powers and extensive activities which must be understood in order to judge fairly whether the United States intelligence system needs reform and change. The Committee believes that many of its general recommendations can and should be applied to the intelligence operations of all other government agencies.

Based on its investigation, the Committee concludes that solutions to the main problems can be developed by analyzing the broad patterns emerging from the examination of particular cases. At the same time, neither the dangers, nor the causes of abuses within the intelligence system, nor their possible solutions can be fairly understood without evaluating the historical context in which intelligence operations have been conducted.

Individual cases and programs of government surveillance which the Committee examined raise questions concerning the inherent conflict between the government's perceived need to conduct surveillance and the citizens' constitutionally protected rights of privacy and dissent. It has become clear that if some lose their liberties unjustly, all may lose their liberties. The protections and obligations of law must apply to all. Only by looking at the broad scope of questionable activity over a long period can we realistically assess the potential dangers of intrusive government. For example, only through an understanding of the

totality of government efforts against dissenters over the past thirty years can one weigh the extent to which such an emphasis may "chill" legitimate free expression and assembly.

The Select Committee has conducted the only thorough investigation ever made of United States intelligence and its post World War II emergence as a complex, sophisticated system of multiple agencies and extensive activities. The Committee staff of 100, including 60 professionals, has assisted the 11 members of the Committee in this in-depth inquiry which involved more than 800 interviews, over 250 executive hearings, and documentation in excess of 110,000 pages.

The advice of former and current intelligence officials, Cabinet members, State, Defense, and Justice Department experts, and citizens from the private sector who have served in national security areas has been sought throughout the Committee's inquiry. The Committee has made a conscious effort to seek the views of all principal officials who have served in the intelligence agencies since the end of World War II. We also solicited the opinions of constitutional experts and the wisdom of scientists knowledgeable about the technology used by intelligence agencies. It was essential to learn the views of these sources outside of the government to obtain as full and balanced an understanding of intelligence activities as possible.

The fact that government intelligence agencies resist any examination of their secret activities even by another part of the same government should not be minimized. The intelligence agencies are a sector of American government set apart. Employees' loyalties to their organizations have been conditioned by the closed, compartmented and secretive circumstances of their agencies' formation and operation. In some respects, the intelligence profession resembles monastic life with some of the disciplines and personal sacrifices reminiscent of medieval orders. Intelligence work is a life of service, but one in which the norms of American national life are sometimes distressingly distorted.

Despite its legal Senate mandate, and the issuance of subpoenas, in no instance has the Committee been able to examine the agencies' files on its own. In all the agencies, whether CIA, FBI, NSA, INR, DIA, or the NSC, documents and evidence have been presented through the filter of the agency itself.

Although the Senate inquiry was congressionally ordered and although properly constituted committees under the Constitution have the right of full inquiry, the Central Intelligence Agency and other agencies of the executive branch have limited the Committee's access to the full record. Several reasons have been given for this limitation. In some instances, the so-called doctrine of executive privilege has been asserted. Despite these assertions of executive privilege, there are no classes of documents which the Committee has not obtained, whether from the NSC, the personal papers of former Presidents and their advisors, or, as in the case of the Committee's Report on Alleged Assassination Plots Involving Foreign Leaders, all classes of documents available in the executive branch. The exception, of course, involves the Nixon files which were not made available because of court order.

It should be noted that in some highly important areas of its in-

investigation, the Committee has been refused access to files or documents. These involve, among others, the arrangements and agreements made between the intelligence agencies and their informers and sources, including other intelligence agencies and governments. The Committee has agreed that in general, the names of agents, and their methods of conducting certain intelligence activities should remain in the custody of a few within the executive branch. But there is a danger and an uncertainty which arises from accepting at face value the assertions of the agencies and departments which in the past have abused or exceeded their authority. If the occasion demands, a duly authorized congressional committee must have the right to go behind agency assertions, and review the full evidence on which agency responses to committee inquiries have been based. There must be a check: some means to ascertain whether the secrets being kept are, in fact, valid national secrets. The Committee believes that the burden of proof should be on those who ask that a secret program or policy be kept secret.

The Committee's report consists of a number of case studies which have been pursued to the best of the Committee's ability and which the Committee believes illuminate the purposes, character, and usefulness of the shielded world of intelligence activities. The inquiry conducted over the past 15 months will probably provide the only broad insight for some time into the now permanent role of the intelligence community in our national government. Because of this, and because of the need to assure that necessary secret activities remain under constitutional control, the recommendations set forth by the Committee are submitted with a sense of urgency and with the admonition that to ignore the dangers posed by secret government action is to invite the further weakening of our democracy.

D. THE HISTORICAL CONTEXT OF THE INQUIRY

The thirty years since the end of World War II have been marked by continuing experimentation and change in the scope and methods of the United States Government's activities abroad. From the all-out World War between the Axis powers and the allies, to the Cold War and fears of nuclear holocaust between the communist bloc and Western democratic powers, to the period of "wars of liberation" in the former colonial areas, the world has progressed to an era of negotiations leading to some easing of tensions between the United States and the Soviet Union. In addition, the People's Republic of China has emerged as a world power which the United States and other nations must consider. The recognizable distinctions between declared war and credible peace have been blurred throughout these years by a series of regional wars and uprisings in Asia, the Middle East, Latin America, Europe, and Africa. The competing great powers have participated directly or indirectly in almost all of these wars.

Of necessity, this country's intelligence agencies have played an important role in the diplomacy and military activities of the United States during the last three decades. Intelligence information has helped shape policy, and intelligence resources have been used to carry out those policies.

The fear of war, and its attendant uncertainties and doubts, has fostered a series of secret practices that have eroded the processes of open democratic government. Secrecy, even what would be agreed by reasonable men to be necessary secrecy, has, by a subtle and barely perceptible accretive process, placed constraints upon the liberties of the American people.

Shortly after World War II, the United States, based on its wartime experience, created an intelligence system with the assigned mission at home and abroad of protecting to protect the national security, primarily through the gathering and evaluation of intelligence about individuals, groups, or governments perceived to threaten or potentially threaten the United States. In general, these intelligence functions were performed with distinction. However, both at home and abroad, the new intelligence system involved more than merely acquiring intelligence and evaluating information; the system also undertook activities to counter, combat, disrupt, and sometimes destroy those who were perceived as enemies. The belief that there was a need for such measures was widely held, as illustrated in the following report related to the 1954 Hoover Commission Report on government organization:

It is now clear that we are facing an implacable enemy whose avowed objective is world domination by whatever means and at whatever cost. There are no rules in such a game. Hitherto acceptable norms of human conduct do not apply. If the U.S. is to survive, long-standing American concepts of "fair play" must be reconsidered. We must develop effective espionage and counterespionage services. We must learn to subvert, sabotage and destroy our enemies by more clever, more sophisticated and more effective methods than those used against us. It may become necessary that the American people will be made acquainted with, understand and support this fundamentally repugnant philosophy.

The gray, shadowy world between war and peace became the natural haunt for covert action, espionage, propaganda, and other clandestine intelligence activities. Former Secretary of State Dean Rusk described it as the environment for the nasty wars "in the back alleys of the world."

Although there had been many occasions requiring intelligence-gathering and secret government action against foreign and domestic national security threats prior to World War II, the intelligence community developed during and after that war is vastly different in degree and kind from anything that had existed previously. The sig-

nificant new facets of the post-war system are the great size, technological capacity and bureaucratic momentum of the intelligence apparatus, and, more importantly, the public's acceptance of the necessity for a substantial permanent intelligence system. This capability contrasts with the previous sporadic, *ad hoc* efforts which generally occurred during wars and national emergencies. The extent and magnitude of secret intelligence activities is alien to the previous American experience.

Three other developments since World War II have contributed to the power, influence and importance of the intelligence agencies.

First, the executive branch generally and the President in particular have become paramount within the federal system, primarily through the retention of powers accrued during the emergency of World War II. The intelligence agencies are generally responsible directly to the President and because of their capabilities and because they have usually operated out of the spotlight, and often in secret, they have also contributed to the growth of executive power.

Second, the direct and indirect impact of federal programs on the lives of individual citizens has increased tremendously since World War II.

Third, in the thirty years since World War II, technology has made unparalleled advances. New technological innovations have markedly increased the agencies' intelligence collection capabilities, a circumstance which has greatly enlarged the potential for abuses of personal liberties. To illustrate, the SALT negotiations and treaties have been possible because technological advances make it possible to accurately monitor arms limitations, but the very technology which permits such precise weapons monitoring also enables the user to intrude on the private conversations and activities of citizens.

The targets of our intelligence efforts after World War II—the activities of hostile intelligence services, communists, and groups associated with them both at home and abroad—were determined by successive administrations. In the 1960's, as the civil rights movement grew in the country, some intelligence agencies directed attention to civil rights organizations and groups hostile to them, such as the Ku Klux Klan. From the mid-1960's until the end of the Vietnam war, intelligence efforts were focused on antiwar groups.

Just as the nature of intelligence activity has changed as a result of international and national developments, the public's attitude toward intelligence has also altered. During the last eight years, beginning with *Ramparts* magazine's exposure of CIA covert relationships with non-governmental organizations, there has been a series of allegations in the press and Congress which have provoked serious questions about the conduct of intelligence agencies at home and abroad. The Watergate disclosures raised additional questions concerning abuse of power by the executive branch, misuse of intelligence agencies, and the need to strengthen legal restraints against such abuses.

While the evidence in the Committee's Report emphasizes the misguided or improper activities of a few individuals in the executive branch, it is clear that the growth of intelligence abuses reflects a more general failure of our basic institutions.

² See the Select Committee's detailed report on "Intelligence and Technology."

Throughout its investigation, the Committee has carefully inquired into the role of presidents and their advisors with respect to particular intelligence programs. On occasion, intelligence agencies concealed their programs from those in higher authority, more frequently it was the senior officials themselves who, through pressure for results, created the climate within which the abuses occurred. It is clear that greater executive control and accountability is necessary.

The legislative branch has been remiss in exercising its control over the intelligence agencies. For twenty-five years Congress has appropriated funds for intelligence activities. The closeted and fragmentary accounting which the intelligence community has given to a designated small group of legislators was accepted by the Congress as adequate and in the best interest of national security. There were occasions when the executive intentionally withheld information relating to intelligence programs from the Congress, but there were also occasions when the principal role of the Congress was to call for more intelligence activity, including activity which infringed the rights of citizens. In general, as with the executive, it is clear that Congress did not carry out effective oversight.

The courts have also not confronted intelligence issues. As the Supreme Court noted in 1972 in commenting on warrantless electronic surveillance, the practice had been permitted by successive presidents for more than a quarter of a century without "guidance from the Congress or a definitive decision of the Courts". Of course, courts only consider the issues brought before them by litigants, and pervasive secrecy—coupled with tight judicially imposed rules of standing—have contributed to the absence of judicial decisions on intelligence issues. Nevertheless, the Committee's investigation has uncovered a host of serious legal and constitutional issues relating to intelligence activity and it is strong proof of the need for reform to note that scarcely any of those issues have been addressed in the courts.

Throughout the period, the general public, while generally excluded from debate on intelligence issues, nevertheless supported the known and perceived activities of the intelligence agencies. In the few years prior to the establishment of this Committee, however, the public's awareness of the need to examine intelligence issues was heightened. The series of allegations and partial exposures in the press and the Congress provoked serious questions about the conduct of intelligence activities at home and abroad. The Watergate affair increased the public's concern about abuse of governmental power and caused greater attention to be paid to the need to follow and to strengthen the role of law to check such abuses.

Against this background, the Committee considered its main task as making informed recommendations and judgments on the extent to which intelligence activities are necessary and how such necessary activities can be conducted within the framework of the Constitution.

E. THE DILEMMA OF SECRECY AND OPEN CONSTITUTIONAL GOVERNMENT

Since World War II, with steadily escalating consequences, many decisions of national importance have been made in secrecy, often by the executive branch alone. These decisions are frequently based on

information obtained by clandestine means and available only to the executive branch. Until very recently, the Congress has not shared in this process. The cautions expressed by the Founding Fathers and the constitutional checks designed to assure that policymaking not become the province of one man or a few men have been avoided on notable recent occasions through the use of secrecy. John Adams expressed his concern about the dangers of arbitrary power 200 years ago:

Whenever we leave principles and clear positive laws we are soon lost in the wild regions of imagination and possibility where arbitrary power sits upon her brazen throne and governs with an iron scepter.

Recent Presidents have justified this secrecy on the basis of "national security," "the requirements of national defense," or "the confidentiality required by sensitive, ongoing negotiations or operations." These justifications were generally accepted at face value. The Bay of Pigs fiasco, the secret war in Laos, the secret bombing of Cambodia, the anti-Allende activities in Chile, the Watergate affair, were all instances of the use of power cloaked in secrecy which, when revealed, provoked widespread popular disapproval. This series of events has ended, for the time being at least, passive and uncritical acceptance by the Congress of executive decisions in the areas of foreign policy, national security and intelligence activities. If Congress had met its oversight responsibilities some of these activities might have been averted.

An examination of the scope of secret intelligence activities undertaken in the past three decades reveals that they ranged from war to conventional espionage. It appears that some United States intelligence activities may have violated treaty and covenant obligations, but more importantly, the rights of United States citizens have been infringed upon. Despite citizen and congressional concern about these programs, no processes or procedures have been developed by either the Congress or the executive branch which would assure Congress of access to secret information which it must have to carry out its constitutional responsibilities in authorizing and giving its advice and consent. The hindsight of history suggests that many secret operations were ill-advised or might have been more beneficial to United States interests had they been conducted openly, rather than secretly.

What is a valid national secret? What can properly be concealed from the scrutiny of the American people, from various segments of the executive branch or from a duly constituted oversight body of their elected representatives? Assassination plots? The overthrow of an elected democratic government? Drug testing on unwitting American citizens? Obtaining millions of private cables? Massive domestic spying by the CIA and the military? The illegal opening of mail? Attempts by an agency of the government to blackmail a civil rights leader? These have occurred and each has been withheld from scrutiny by the public and the Congress by the label "secret intelligence."

In the Committee's view, these illegal, improper or unwise acts are not valid national secrets and most certainly should not be kept from the scrutiny of a duly-constituted congressional oversight body.

The definition of a *valid* national secret is far more difficult to set forth. It varies from time to time. There is presently general agree-

ment that details about military activities, technology, sources of information and particular intelligence methods are secrets that should be carefully protected. It is most important that a process be devised for agreeing on what national secrets are, so that the reasons for necessary secrecy are understood by all three branches of government and the public, that they be under constant review, and that any changes requiring the protection of new types of information can be addressed, understood and agreed on within a framework of constitutional consensus.

The Committee stresses that these questions remain to be decided by the Congress and the executive jointly :

- What should be regarded as a national secret?
- Who determines what is to be kept secret?
- How can decisions made in secret or programs secretly approved be reviewed?

Two great problems have confronted the Committee in carrying out its charge to address these issues :

The first is how our open democratic society, which has endured and flourished for 200 years, can be adapted to overcome the threats to liberty posed by the continuation of secret government activities. The leaders of the United States must devise ways to meet their respective intelligence responsibilities, including informed and effective congressional oversight, in a manner which brings secrecy and the power that secrecy affords within constitutional bounds.

For the executive branch, the specific problem concerns instituting effective control and accountability systems and improving efficiency. Many aspects of these two problem areas which have been examined during the Committee's inquiry of intelligence agencies are addressed in the recommendations in Chapter XVIII. It is our hope that intelligence oversight committees working with the executive branch will develop legislation to remedy the problems exposed by our inquiry and described in this report. The Committee has already recommended the creation of an oversight committee with the necessary powers to exercise legislative authority over the intelligence activities of the United States.

It is clear that the Congress must exert its will and devise procedures that will enable it to play its full constitutional role in making policy decisions concerning intelligence activities. Failure to do so would permit further erosion of constitutional government.

This Committee has endeavored to include in its final public report enough information to validate its findings and recommendations. Most of the inquiry and the documentation obtained by the Committee, particularly that concerning foreign and military intelligence, is of a highly classified nature. Determining what could and should be revealed has been a major concern.

In a meeting with President Ford at the outset of our inquiry in February 1975, the Committee agreed not to disclose any classified information provided by the executive branch without first consulting the appropriate agencies, offices and departments. In the case of objections, the Committee agreed to carefully consider the Executive's reasons for maintaining secrecy, but the Committee determined that final decisions on any disclosure would be up to the Committee.

The Select Committee has scrupulously adhered to this agreement. The Interim Report on Alleged Assassination Plots Involving Foreign Leaders, the report on CIA activities in Chile, the report on illegal NSA surveillances, and the disclosures of illegal activities on the part of FBI COINTELPRO, the FBI's harassment of Dr. Martin Luther King, Jr., and other matters revealed in the Committee's public hearings, were all carefully considered by the Committee and the executive branch working together to determine what information could be declassified and revealed without damaging national security. In those reports and hearings, virtually all differences between the Committee and the Executive were resolved. The only significant exception concerned the release to the public of the Assassination Report, which the executive branch believed would harm national security. The Committee decided otherwise.

Some criteria for defining a valid national secret have been agreed to over the past year. Both the Committee and the executive branch now agree that generally the names of intelligence sources and the details of sensitive methods used by the intelligence services should remain secret. Wherever possible, the right of privacy of individuals and groups should also be preserved. It was agreed, however, that the details of illegal acts should be disclosed and that the broad scope of United States intelligence activities should be sufficiently described to give public reassurance that the intelligence agencies are operating consistent with the law and declared national policy.

The declassification working procedures developed between this Committee, the CIA and other parts of the intelligence community constitute the beginnings of agreed, sound and sensible methods and criteria for making public matters that should be made public. This disclosure process is an important step toward achieving the national consensus required if our intelligence system is to enjoy essential public support.

There is a clear necessity, after thirty years of substantial secret activities, for public debate and legislative decisions about the future course of our intelligence system. This report is intended to assist the Senate, the Congress, and the country in making the vital decisions that are required to be made in the coming years.

This section of the Final Report focuses on the departments and agencies engaged in foreign and military intelligence. The Committee's findings, conclusions, and recommendations in these areas can be found in Chapter XVIII.

II. THE FOREIGN AND MILITARY INTELLIGENCE OPERATIONS OF THE UNITED STATES: AN OVERVIEW

Permanent institutions for the conduct of secret foreign and military intelligence activities are a relatively new feature of American government. Secure behind two oceans and preoccupied with the settlement of a continent, America had no permanent foreign intelligence establishment for more than a century and a half. In times of crisis, Americans improvised their intelligence operations. In times of peace, such operations were not needed and were allowed to lie fallow.

Despite the experience of the First World War, Americans believed they could continue this pattern well into the Twentieth Century. The military services developed important technical intelligence capabilities, such as the breaking of the Japanese code, but the American public remained unaware of the importance of effective intelligence for its security. As a world power, the United States came late to intelligence. It came on December 7, 1941, when Japan attacked Pearl Harbor.

That searing intelligence failure led to the Congress' first effort to deal with the necessity and complexity of modern intelligence. The Joint Committee on the Pearl Harbor Attack, after a sweeping investigation, recommended in 1946 a unified and permanent intelligence effort by the United States—concepts ultimately embodied in the basic charter for American intelligence, The National Security Act adopted by the Congress in 1947. However, neither the Pearl Harbor Committee, nor the National Security Act addressed some of the fundamental problems secret intelligence operations pose for our democratic and constitutional form of government and America's unique system of checks and balances.

The Senate Select Committee on Intelligence Activities represents the second major effort by the Congress to come to grips with intelligence problems, in particular the basic constitutional and structural issues arising from a permanent secret intelligence establishment. While these problems were the subject of the investigation and are the focus of this report, the Select Committee wishes to emphasize that it found much that was good and proper in America's intelligence efforts. In particular, the capacity and dedication of the men and women serving in our intelligence services is to be commended.

This inquiry was not brought forth by an individual event such as a massive intelligence failure threatening the nation's security. Rather it is the result of a series of occurrences adversely affecting the liberties of individual Americans and undermining the long-term interests and reputation of the United States. In effect, the Select Committee was created to deal with the question of whether our democratic system has effectively governed in the crucial area of secret intelligence.

Mr. Clark Clifford, one of the authors of the National Security Act of 1947, told the Committee that:

The law that was drawn in 1947 was of a general nature and properly so, because it was the first law of its kind. We were blazing a new trail.¹

It has been the responsibility of the Select Committee to consider where this secret trail has taken the nation, and with this as prologue, to begin the task of charting the future.

A. THE BASIC ISSUES: SECRECY AND DEMOCRACY

The task of democratic government is to reconcile conflicting values. The fundamental question faced by the Select Committee is how to reconcile the clash between secrecy and democratic government itself. Secrecy is an essential part of most intelligence activities. However, secrecy undermines the United States Government's capacity to deal effectively with the principal issues of American intelligence addressed by the Select Committee:

—The lack of clear legislation defining the authority for permissible intelligence activities has been justified in part for reasons of secrecy. Absent clear legal boundaries for intelligence activities, the Constitution has been violated in secret and the power of the executive branch has gone unchecked, unbalanced.

—Secrecy has shielded intelligence activities from full accountability and effective supervision both within the executive branch and by the Congress.

—Reliance on covert action has been excessive because it offers a secret shortcut around the democratic process. This shortcut has led to questionable foreign involvements and unacceptable acts.

—The important line between public and private action has become blurred as the result of the secret use of private institutions and individuals by intelligence agencies. This clandestine relationship has called into question their integrity and undermined the crucial independent role of the private sector in the American system of democracy.

—Duplication, waste, inertia and ineffectiveness in the intelligence community has been one of the costs of insulating the intelligence bureaucracy from the rigors of Congressional and public scrutiny.

—Finally, secrecy has been a tragic conceit. Inevitably, the truth prevails, and policies pursued on the premise that they could be plausibly denied, in the end damage America's reputation and the faith of her people in their government.

For three decades, these problems have grown more intense. The United States Government responded to the challenge of secret intelligence operations by resorting to procedures that were informal, implicit, tacit. Such an approach could fit within the tolerances of our democratic system so long as such activities were small or temporary. Now, however, the permanence and scale of America's intelligence effort and the persistence of its problems require a different solution.

¹ Clark Clifford testimony, 12/5/75, Hearings, vol. 7, p. 50.

B. THE SCOPE OF THE SELECT COMMITTEE'S INQUIRY INTO FOREIGN AND MILITARY INTELLIGENCE OPERATIONS

The operations of the United States Government in the field of intelligence involve the activities of hundreds of thousands of individuals and the expenditure of billions of dollars. They are carried out by a complex "community" of organizations whose functions interact and overlap. Because of their scope, the Select Committee could not deal in depth with all aspects of America's intelligence activities. Instead the Committee focused on the principal organizations, their key functions and the major issues confronting the United States in the field of foreign and military intelligence. In doing so, the Committee sought to uncover the truth of alleged abuses by the intelligence agencies and to ascertain the legitimate needs and requirements of an effective future intelligence system for the United States that can function within the boundaries established by the Constitution and our democratic form of government.

The Select Committee focused on five institutions:

—*The National Security Council (NSC)*, which on behalf of the President, is supposed to direct the entire national security apparatus of the United States Government, including the intelligence community. As the senior policymaking body in the executive branch in the field of national security, the NSC is also the ultimate consumer of the nation's intelligence product.

—*The Director of Central Intelligence (DCI)*, who is charged with producing intelligence which reflects the judgments of all of the intelligence organizations in the executive branch. He is also supposed to "coordinate" the activities of these organizations.

—*The Central Intelligence Agency*, which houses the government's central analytical staff for the production of intelligence, but which devotes its major efforts to developing new means of technical collection and to operating America's clandestine intelligence service throughout the world. In the latter capacity it carries out covert action, paramilitary operations and espionage.

—*The Department of State*, which is the primary source of intelligence on foreign political and economic matters, and as such is both a competitor in the collection and evaluation of intelligence and a potential source of external control over clandestine intelligence activities of the Central Intelligence Agency.

—*The Department of Defense*, which is the major collector of intelligence, the largest consumer, as well as the principal manager of the resources devoted to intelligence. It houses the largest intelligence collection organization, the National Security Agency (NSA), and the largest intelligence analysis organization, the Defense Intelligence Agency (DIA).

C. THE INTELLIGENCE PROCESS: THEORY AND REALITY

These organizations, and some of their offshoots, constitute the United States intelligence community. In theory at least, their operations can be described in simple terms by the following cycle:

—Those who use intelligence, the “consumers,” indicate the kind of information needed.

—These needs are translated into concrete “requirements” by senior intelligence managers.

—The requirements are used to allocate resources to the “collectors” and serve to guide their efforts.

—The collectors obtain the required information or “raw intelligence.”

—The “raw intelligence” is collated and turned into “finished intelligence” by the “analysts.”

—The finished intelligence is distributed to the consumer and the intelligence managers who state new needs, define new requirements, and make necessary adjustments in the intelligence programs to improve effectiveness and efficiency.

In reality this pattern is barely recognizable.

There are many different consumers, from the President to the weapons designer. Their needs can conflict. Consumers rarely take the time to define their intelligence needs and even if they do so there is no effective and systematic mechanism for translating them into intelligence requirements.

Therefore, intelligence requirements reflect what intelligence managers think the consumers need, and equally important, what they think their organizations can produce. Since there are many managers and little central control, each is relatively free to set his own requirements.

Resources therefore tend to be allocated according to the priorities and concerns of the various intelligence bureaucracies. Most intelligence collection operations are part of other organizations—the Department of Defense, the Department of State—and so their requirements and their consumers are often the first to be served.

Collecting intelligence is not an automatic process. There are many different kinds of intelligence, from a radar return to an indiscreet remark, and the problems in acquiring it vary greatly. Information that is wanted may not be available, or years may be required to develop an agency or a technical device to get it. Meanwhile intelligence agencies collect what they can.

In the world of bureaucracy, budgets, programs, procurement, and managers, the needs of the analyst can be lost in the shuffle. There has been an explosion in the volume and quality of raw intelligence but no equivalent increase in the capacity of analytical capabilities. As a result, “raw” intelligence increasingly dominates “finished” intelligence; analysts find themselves on a treadmill where it is difficult to do more than summarize and put in context the intelligence flowing in. There is little time or reward for the task of providing insight.

In the end the consumer, particularly at the highest levels of the government, finds that his most important questions are not only unanswered, but sometimes not even addressed.

To some extent, all this is in the nature of things. Many questions cannot be answered. The world of intelligence is dominated by uncertainty and chance, and those in the intelligence bureaucracy, as else-

where in the Government, try to defend themselves against uncertainties in ways which militate against efficient management and accountability.

Beyond this is the fact that the organizations of the intelligence community must operate in peace but be prepared for war. This has an enormous impact on the kind of intelligence that is sought, the way resources are allocated, and the way the intelligence community is organized and managed.

Equally important, the instruments of intelligence have been forged into weapons of psychological, political, and paramilitary warfare. This has had a profound effect on the perspective and preoccupations of the leadership of the intelligence community, downgrading concerns for intelligence in relation to the effective execution of operations.

These problems alone would undermine any rational scheme, but it is also important to recognize that the U.S. intelligence community is not the work of a single author. It has evolved from an interaction of the above internal factors and the external forces that have shaped America's history since the end of the Second World War.

D. EVOLUTION OF THE UNITED STATES INTELLIGENCE COMMUNITY

The evolution of the United States intelligence community since World War II is part of the larger history of America's effort to come to grips with the spread of communism and the growing power of the Soviet Union. As the war ended, Americans were torn by hopes for peace and fear for the future. The determination to return the nation promptly to normal was reflected in demobilization of our wartime military establishment. In the field of intelligence, it was clear in President Truman's decision to dismantle the Office of Strategic Services, scattering its functions to the military departments and the Department of State.

The Second World War saw the defeat of one brand of totalitarianism. A new totalitarian challenge quickly arose. The Soviet Union, a major ally in war, became America's principal adversary in peace. The power of fascism was in ruin but the power of communism was mobilized. Not only had the communist parties in France, Italy, and Greece emerged politically strengthened by their roles in the Resistance, but the armies of the Soviet Union stretched across the center of Europe. And, within four years, America's nuclear monopoly would end.

American military intelligence officers were among the first to perceive the changed situation. Almost immediately after the fall of Berlin to the Red Army, U.S. military intelligence sought to determine Soviet objectives. Harry Rositzke, later to become chief of the CIA's Soviet Division, but at the time a military intelligence officer, was despatched to Berlin by jeep. Although the Soviet Union was still an ally, Rositzke was detained, interrogated, then ordered expelled by the Soviet occupying forces. He managed, however, to escape his Soviet "escort" and arrive in Berlin. He described his experience to the Committee:

We got on the outskirts of Berlin and yelled out "Amerikanski," and were highly welcomed. And as we went over the Autobahn the first basic impression I got, since I had known

Germany well before the war, was a long walking group of German males under 16 and over 60 who were being shepherded to the east by four-foot-ten, five-foot Mongolian soldiers with straw shoes.

The Russians also had been looting. With horses and farm wagons they were taking away mattresses, wall fixtures, plumbing fixtures, anything other than the frame of the houses.

We then made our way through the rubble of Berlin—most were one-way streets—identifying every shoulder patch we could, and passed the Siemens-Halske works, in front of which were 40 or 50 lend-lease trucks, on each of which was a large shiny lathe, drill press, et cetera.

When we had seen enough and were all three extremely nervous, we headed straight west from Berlin to the British Zone. When we arrived we had an enormous amount of exuberance and a real sense of relief, for the entire 36 hours had put us in another world. The words that came to my mind then were, "Russia moves west."³

At home, the Truman Administration was preoccupied by the transition from war to an uncertain peace. Though dispersed, and in some cases disbanded, America's potential capabilities in the field of intelligence were considerable. There were a large number of well-trained former OSS operation officers; the military had developed a remarkable capacity for cryptologic intelligence (the breaking of codes) and communications intelligence (COMINT); there was also a cadre of former OSS intelligence analysts both within the government and in the academic community.

E. THE ORIGINS OF THE POSTWAR INTELLIGENCE COMMUNITY⁴

With the experiences of World War II and particularly Pearl Harbor still vivid, there was a recognition within the government that, notwithstanding demobilization, it was essential to create a centralized body to collate and coordinate intelligence information. There was also a need to eliminate factions between competing military intelligence services. Although there was disagreement about the structure and authority of the postwar intelligence service, President Truman and his senior advisers concluded that, unlike the OSS, this centralized body should be civilian in character.

The military resisted this judgment. Virtually all of America's competing intelligence assets were in the armed services. Then, as now, the military considered an intelligence capability essential in wartime and equally important in time of peace to be prepared for military crises. Thus, the services were strongly opposed to having their authority over intelligence diminished. In contrast, factions within the State Department were reluctant to accept any greater responsibility or role in the field of clandestine intelligence.

Six months after V-J Day, and three months after he had disbanded OSS, President Truman established the Central Intelligence

³ Harry Rozitzke testimony, 10/31/75, p. 7.

⁴ For an organizational history of the CIA, see Chapter VI.

Group (CIG). CIG was the direct predecessor of the CIA. It reported to the National Intelligence Authority, a body consisting of the Secretaries of State, War and Navy and their representatives. CIG had a brief existence. It never was able to overcome the constraints and institutional resistances found in the Department of State and the armed services.

The National Security Act of 1947^o was passed on July 26, 1947. The Act included, in large part, the recommendations of a report prepared for Secretary of the Navy James Forrestal by New York investment broker Ferdinand Eberstadt. Though largely concerned with the creation of the National Security Council (NSC) and the unification of the military services within the Department of Defense, the Act also created a Director of Central Intelligence (DCI) and a Central Intelligence Agency (CIA). The powers of the DCI and the CIA were an amalgam of careful limits on the DCI's authority over the intelligence community and an open-ended mission for the CIA itself. The power of the DCI over military and diplomatic intelligence was confined to "coordination." At the same time, however, the Agency was authorized to carry out unspecified "services of common concern" and, more importantly, could "carry out such other functions and duties" as the National Security Council might direct.

Nowhere in the 1947 Act was the CIA explicitly empowered to collect intelligence or intervene secretly in the affairs of other nations. But the elastic phrase, "such other functions," was used by successive presidents to move the Agency into espionage, covert action, paramilitary operations, and technical intelligence collection. Often conceived as having granted significant peacetime powers and flexibility to the CIA and the NSC, the National Security Act actually legislated that authority to the President.

The 1947 Act provided no explicit charter for military intelligence. The charter and mission of military intelligence activities was established either by executive orders, such as the one creating the National Security Agency in 1952, or various National Security Council Directives. These National Security Council Intelligence Directives (NSCID's) were the principal means of establishing the roles and functions of all the various entities in the intelligence community. They composed the so-called "secret charter" for the CIA. However, most of them also permitted "departmental" intelligence activities, and in this way also provided the executive charter for the intelligence activities of the State Department and the Pentagon. However, the intelligence activities of the Department of Defense remained with the military rather than with the new Defense Department civilians. At the end of the war, the Joint Chiefs of Staff decided to continue the inter-Service coordinating mechanism—the Joint Intelligence Committee—which had been created in 1942. With the 1947 Act and the establishment of the Joint Chiefs of Staff, a working level intelligence operation was created in the Joint Staff, known as the Joint Intelligence Group, or J-2.

The structure created by the 1947 Act and ensuing NSCID's was highly decentralized. The task of the CIA and the Director of Central

^o See Chapter VII for an analysis of the 1947 Act.

Intelligence was to "coordinate" the intelligence output of all the various intelligence collection programs in the military and the Department of State. The CIA and its Director had little power to act itself, but the potential was there.

F. THE RESPONSE TO THE SOVIET THREAT

Immediately after its establishment, the CIA and other elements of the intelligence community responded to the external threats facing the United States.

—*The threat of war in Europe.* Following the war there was a distinct possibility of a Soviet assault on Western Europe. Communist regimes had been established in Poland, Hungary, Romania and Bulgaria. Czechoslovakia went Communist in 1948 through a coup supported by the Russian Army. There was a Russian-backed civil war in Greece. And, above all, there was the presence of the Soviet Army in Eastern Europe and the pressure on Berlin.

In light of these developments, U.S. policymakers came to the conclusion that outright war with the Soviet Union was possible. The U.S. intelligence community responded accordingly. The CIA assumed the espionage task, running agents and organizing "stay-behind networks" in the event the Soviets rolled west. Agents, mostly refugees, were sent into the East to report on Soviet forces and, in particular, any moves that signalled war. The U.S. went so far as to establish contact with Ukrainian guerrillas—a relationship that was maintained until the guerrillas were finally wiped out in the early 1950s by Soviet security forces. CIA activities, however, were outnumbered by the clandestine collection operations of the military, particularly in Western Europe, where the Army maintained a large covert intelligence and paramilitary capability.

—*Turmoil in the West.* The Soviets had powerful political resources in the West—the Communist parties and trade unions. Provided with financial and advisory support from the Soviet Union, the Communist parties sought to exploit and exacerbate the economic and political turmoil in postwar Europe. As the elections in 1948 and 1949 in Italy and France approached, the democratic parties were in disarray and the possibility of a Communist takeover was real. Coordinated Communist political unrest in western countries combined with extremist pressure from the Soviet Union, confirmed the fears of many that America faced an expansionist Communist monolith.

The United States responded with overt economic aid—the Truman Doctrine and the Marshall Plan—and covert political assistance. This latter task was assigned to the Office of Special Projects, later renamed the Office of Policy Coordination (OPC). The Office was housed in the CIA but was directly responsible to the Departments of State and Defense. Clandestine support from the United States for European democratic parties was regarded as an essential response to the threat of "international communism." OPC became the fastest growing element in the CIA. To facilitate its operations, as well as to finance CIA espionage activities, the Congress passed the Central Intelligence Agency Act of 1949, which authorized the Director of CIA to spend funds on his voucher without having to account for disbursements.

—*Nuclear weapons.* The advent of nuclear weapons and the Soviet potential in this field led to efforts to ascertain the status of the Soviet Union's nuclear program. By the time of the Soviet's first atomic explosion in 1949, the U.S. Air Force and Navy had begun a peripheral reconnaissance program to monitor other aspects of Soviet nuclear development and Soviet military capabilities. As the Soviet strategic nuclear threat grew, America's efforts to contain it would grow in scale and sophistication until it would overshadow the classic tools of espionage.

. G. KOREA: THE TURNING POINT

The Communist attack, feared in Europe, took place in Asia. The Korean War, following less than a year after the fall of China to the Communists, marked a turning point for the CIA. The requirements of that war, the involvement of China, the concern that war in Europe might soon follow, led to a fourfold expansion of the CIA—particularly in the paramilitary field. This period was characterized by efforts to infiltrate agents into mainland China, which led to the shoot-down and capture of a number of Americans.

The CIA's activities elsewhere in Asia also expanded. Instrumental in helping Ramon Magsaysay defeat the communist Hukbalahaps in the Philippines, the CIA also assisted the French in their losing struggle against the Viet Minh in Indochina.

The failure to anticipate the attack on Korea was regarded as a major intelligence failure. The new Director of the CIA, General Bedell Smith, was determined to improve CIA's estimating and forecasting capabilities. He called on William Langer, formerly chief of the Research and Analysis section of the OSS, to come to Washington from Harvard, in 1950, to head a small staff for analysis and the production of intelligence. An Office of National Estimates (ONE) was established to produce finished intelligence estimates. ONE drew on the intelligence information resources of the entire U.S. intelligence community and was aided by a Board of National Estimates composed of leading statesmen and academic experts.

By the end of the Korean War and the naming of Allen Dulles as DCI, the powers, responsibilities and basic structure of the CIA were established. The Agency had assumed full responsibility for covert operations in 1950, and by 1952 covert action had exceeded the money and manpower allotted to the task of espionage—a situation that would persist until the early 1970s.

Paramilitary actions were in disrepute because of a number of failures during the Korean War. However, the techniques of covert military assistance in training had been developed, and the pattern of CIA direction of Special Forces and other unconventional components of the U.S. Armed Forces in clandestine operations had been established.

In the field of espionage, the CIA had become the predominant, but by no means the exclusive operator. Clandestine human collection of intelligence by the military services continued at a relatively high rate. The military also had a large stake in clandestine technical collection of intelligence.

Major structural changes in the intelligence community were brought about by the consolidation of cryptanalysis and related functions. Codebreaking is a vital part of technical intelligence collection and has had an important role in the history of U.S. intelligence efforts. The American "Black Chamber" responsible for breaking German codes in WWI was abolished in the 1920s. As WWII approached, cryptanalysis received increased attention in the military. Both the Army and Navy had separate cryptologic services which had combined to break the Japanese code. Known as "the magic" this information signalled the impending attack on Pearl Harbor but the intelligence and alert system as a whole failed to respond.

In order to unify and coordinate defense cryptologic and communications security functions, President Truman created the National Security Agency by Executive Order on November 4, 1952. Prior to this time, U.S. cryptological capabilities resided in the separate agencies of the Army, Navy, and Air Force. The very existence of still the most secret of all U.S. intelligence agencies, NSA, was not acknowledged until 1957.

H. THE "PROTRACTED CONFLICT"

With the end of the Korean conflict and as the mid-1950s approached, the intelligence community turned from the desperate concern over imminent war with the U.S.S.R. to the long-term task of containing and competing with communism. In the "struggle for men's minds," covert action developed into a large-scale clandestine psychological and political program aimed at competing with Soviet propaganda and front organizations in international labor and student activities. Specific foreign governments considered antithetical to the United States and its allies or too receptive to the influence of the Soviet Union, such as Mosedegh in Iran in 1953 and Arbenz in Guatemala in 1954, were toppled with the help of the CIA. Anti-communist parties and groups were given aid and encouragement such as the Sumatran leaders who, in 1958, sought the overthrow of President Sukarno of Indonesia.

At the same time, the CIA was moving into the field of technical intelligence and reconnaissance in a major way. The U.S. military had recognized the value of aerial reconnaissance within a few short years after the Wright brothers' successful flight in 1903 and had borne major responsibility for reconnaissance against Communist bloc countries. But it was the CIA in 1959 that began work on the U-2.

It proved to be a technical triumph. The U-2 established that the Soviet Union was not, as had been feared, about to turn the tables of the strategic balance. It gained more information about Soviet military developments than had been acquired in the previous decade of espionage operations. But there were risks in this operation. Despite the effort to minimize them with a special system of high-level NSC review and approval, Francis Gary Powers was shot down in a U-2 over the Soviet Union on the eve of the Paris summit conference in 1960. President Eisenhower's acceptance of responsibility and Nikita Khrushchev's reaction led to the collapse of the conference before it began.

Nonetheless the U-2 proved the value of exotic and advanced technical means of intelligence collection. It was followed by a transfor-

mation of the intelligence community. As the 1950s gave way to the 1960s, large budgets for the development and operation of technical collection systems created intense competition among the military services and the CIA and major problems in management and condensation.

To support the Director of Central Intelligence's task of coordinating the activities of the intelligence community, the United States Intelligence Board (USIB) was established in 1958. Made up of senior representatives of the State Department, the Department of Defense, the military services, Treasury (since 1973) and the FBI, USIB was to coordinate the setting of requirements for intelligence, approve National Intelligence Estimates and generally supervise the operations of the intelligence agencies. However, the real power to set requirements and allocate resources to intelligence programs remained decentralized and in the hands of the principal collectors—the military services, the Foreign Service and the clandestine service of the CIA. As collection programs mushroomed, USIB proved unequal to the task of providing centralized management and eliminating duplication.

I. THIRD WORLD COMPETITION AND NUCLEAR CRISIS

While the United States' technical, military and intelligence capabilities advanced, concern intensified over the vulnerability of the newly independent nations of Africa and Asia to communist subversion. And in the Western Hemisphere the establishment of a communist Cuba by Fidel Castro was seen as presaging a major incursion of revolutionary communism to the Western Hemisphere.

At his inauguration in January, 1961, President Kennedy proclaimed that America would "pay any price and bear any burden" so that liberty might prevail in the world over the "forces of communist totalitarianism." Despite the catastrophe of the CIA-sponsored Bay of Pigs invasion only four months later, the covert action and paramilitary operations staffs of the CIA were to shoulder a significant part of that burden. In Latin America the Alliance for Progress, the overt effort to help modernize the southern half of the hemisphere, was accompanied by a significant expansion of covert action and internal security operations aimed at blocking the spread of Castro's influence or ideology. This was accompanied by an intense paramilitary campaign of harassment, sabotage, propaganda against Cuba, and attempted assassination against Castro.

Nearby, in the Dominican Republic, the United States had already supported the assassins of Dictator Raphael Trujillo in order to preempt a Castro-type takeover. In Africa, significant paramilitary aid was given in support of anti-Soviet African leaders. In Asia, American intelligence had been involved for a long time in the Indochina struggle. The CIA, along with the rest of the United States government, was drawn ever deeper into the Vietnamese conflict.

Early in the decade the United States faced its most serious post-war crisis affecting its security—the Cuban Missile Crisis of October 1962. It illustrated a number of important facts concerning the nature and structure of American intelligence.

During the summer of 1962 overhead reconnaissance confirmed agent intelligence reports that some form of unusual military installation was being placed in Cuba. By October 16 it was clear that these were

medium and intermediate-range ballistic missile sites capable of handling nuclear weapons that could strike targets throughout significant areas of the United States.

As the United States moved towards a confrontation with the Soviet Union, U.S. intelligence played a significant role at every turn. Overhead reconnaissance of the Soviet strategic posture was vastly superior to that of the Russians. Reports from Col. Oleg Penkovsky, the U.S. agent in the Kremlin, kept the United States abreast of the Soviet military response to the crisis. U.S. tactical reconnaissance of Cuba not only prepared the United States for possible invasion but signalled the earnestness of our intention to do so should the situation deteriorate. Naval reconnaissance kept close tabs on Soviet ships bearing ballistic missile components. As the crisis neared its showdown with a quarantine, the President demanded and received the most detailed tactical intelligence, including the distance in yards between American naval vessels and the Soviet transport ships.

This crisis dramatized the importance of integrated intelligence collection and production in times of crisis. It also clearly illustrated the difficulty in distinguishing between national and so-called tactical intelligence. This distinction has been a central feature of the structure of the American intelligence community with the military services maintaining control over tactical intelligence and the so-called national intelligence assets subject to varying degrees of control by the Director of Central Intelligence or the Secretary of Defense and the National Security Council. Cuba proved that in time of crisis these distinctions evaporate.

J. TECHNOLOGY AND TRAGEDY

During the 1960s the U.S. intelligence community was dominated by two developments: First, the enormous explosion in the volume of technical intelligence as the research and development efforts of the previous period came to fruition; second, the ever-growing involvement of the United States in the war in Vietnam.

The increase in the quantity and quality of technically acquired information on Soviet military forces, in particular strategic forces, made possible precise measurement of the existing level of Soviet strategic deployments. However, it did not answer questions about the ultimate scale of Soviet strategic deployments, nor did it provide firm information on the quality of their forces. While it provided an additional clue as to Soviet intentions, it did not offer any definitive answers.

In the Pentagon disparate estimates of future Soviet strategic power from each of the Armed Services led Secretary Robert McNamara to establish the Defense Intelligence Agency. The Secretary of Defense was in the ironic position of being responsible for the bulk of American intelligence collection activity but lacking the means to coordinate either the collection programs or the intelligence produced. The DIA was to fulfill this need, but in a compromise with the military services the DIA was made to report to the Secretary of Defense through the Joint Chiefs of Staff. The DIA has never fulfilled its promise.

In the CIA the analysts confronted by the new mass of technical intelligence information underestimated the ultimate scale of Soviet

deployments while tending to overestimate the qualitative aspects of Soviet weapons systems. Previously, intelligence analysts had to build up their picture of Soviet capability from fragmentary information, inference and speculation, particularly as to Soviet purposes. Confronted with the challenge to exploit the new sources of intelligence on Soviet programs, the analysts in the intelligence community turned away from the more speculative task of understanding Soviet purposes and intentions, even though insight into these questions was central to a greater understanding of the technical information being acquired in such quantity.

The war in Vietnam also posed serious problems in the analysis and production of intelligence. In effect, the analysts were continually in the position of having to bring bad news to top policymakers. The result produced some serious anomalies in the nature of intelligence estimates concerning the Vietnam conflict. For example, the CIA continually flew in the face of the Pentagon and the evident desires of the White House by denigrating the effectiveness of the bombing campaigns over North Vietnam, but as American involvement deepened from 1965 onward, the CIA was unwilling to take on the larger and more important task of assessing the possibility for the success of the overall U.S. effort in Vietnam.

The increase in technical collection capabilities of the United States were also brought to bear on that conflict, creating in its turn important questions about the application of such resources to tactical situations. As one intelligence officer put it, local military commanders in Vietnam "were getting SIGINT (signals intelligence) with their orange juice every morning and have now come to expect it everywhere." This involves two problems: first, whether "national" intelligence resources aimed at strategic problems should be diverted to be used for local combat application and, second, whether this might not lead to a compromise of the technical collection systems and the elimination of their effectiveness for broader strategic missions.

K. THE 1970s

Together, the advent of increased technical capabilities and the Vietnam War brought to a climax concerns within the Government over the centralized management of intelligence resources. This coincided with increased dissatisfaction in the Nixon Administration over the quality of intelligence produced on the war and on Soviet strategic developments.

In the nation as a whole, the impact of the Vietnam War destroyed the foreign policy consensus which had underpinned America's intelligence activities abroad. Starting with the disclosures of CIA involvement with the National Student Association of 1967, there were a series of adverse revelations concerning the activities of the Central Intelligence Agency and the military intelligence agencies.

Concern over the secret war in Laos, revulsion at the Phoenix program which took at least 20,000 lives in South Vietnam, army spying on U.S. civilians, U.S. "destabilization" efforts in Chile, and finally the revelations concerning Operation CHAOS and the CIA's domestic intelligence role created a climate for a thorough Congressional investigation.

During this same period, the Executive moved to initiate certain management reforms. Beginning as early as 1968, there were cutbacks in the scale of the overall intelligence community. These cutbacks deepened by 1970, both in the size of the overall intelligence budget in real terms and in the manpower devoted to intelligence activities. CIA covert activities were sharply reduced with a few notable exceptions such as Chile. The internal security mission in foreign countries was dropped. There was a re-emphasis on collecting covert intelligence on the Soviet Union. Terrorism and narcotics were added to the list of intelligence requirements for our clandestine espionage services.

In 1971 James Schlesinger, then serving in the office of Management and Budget, was asked to do a sweeping analysis of the intelligence community. That study led to an effort to increase the authority of the Director of Central Intelligence over the management of the intelligence community. However, President Nixon limited the scope of reform to that which could be accomplished without legislation.

Congress also took an increased interest in the activities of the intelligence community. The role of the CIA in the Watergate affair was examined in the Senate Watergate Committee's investigation. At the close of 1974 a rider, the Hughes-Ryan amendment, was added to the Foreign Assistance Act which required the President to certify that covert actions were important to the national interest and directed that the Congress be fully informed of them. In this connection, the responsibility to inform the Congress was broadened beyond the traditional Armed Services and Appropriations Committees of the Congress to include the Senate Foreign Relations Committee and the House Foreign Affairs Committee. However, the first real effort of the Congress to come to grips with the challenge posed to the American democratic form of government by necessarily secret foreign and military intelligence activities came with the establishment of the Senate Select Committee on Intelligence in January of 1975. The results of its inquiry are set forth in the following chapters of this report.

L. THE TASK AHEAD

The American intelligence community has changed markedly from the early postwar days, yet some of the major problems of that period persist. The intelligence community is still highly decentralized; the problem of maintaining careful command and control over risky secret activities is still great. There is a continuing difficulty in drawing a line between national intelligence activities, which should be closely supervised by the highest levels of government, and tactical intelligence, which are the province of the military services and the departments.

The positive steps undertaken by President Ford in his recent Executive Order have not diminished the need for a new statutory framework for American intelligence activities. Only through the legislative process can the broad political consensus be expressed which is necessary for the continuing conduct of those intelligence activities essential to the nation's security and diplomacy.

Clark M. Clifford, who was one of the authors of the 1947 National Security Act that established the present legislative framework for America's intelligence activities, made these comments in open session before the Committee:

As one attempts to analyze the difficulty and hopefully offer constructive suggestions for improvement, he finds much confusion existing within the system. It is clear that lines of authority and responsibility have become blurred and indistinct.

The National Security Council under the Act of 1947 is given the responsibility of directing our country's intelligence activities. My experience leads me to believe that this function has not been effectively performed. . . .

The 1947 law creating the CIA should be substantially amended and a new law should be written covering intelligence functions. We have had almost thirty years of experience under the old law and have learned a great deal. I believe it has served us reasonably well but its defects have become increasingly apparent. A clear, more definitive bill can be prepared that can accomplish our purposes by creating clear lines of authority and responsibility and by carefully restricting certain activities we can hopefully prevent the abuses of the past.

And Mr. Clifford concluded:

We have a big job to do in this country. Our people are confused about our national goals and cynical about our institutions. Our national spirit seems to have been replaced by a national malaise. It is my conviction that the efforts of this committee will assist us in regaining confidence in our national integrity, and in helping to restore to our nation its reputation in the world for decency, fair dealing, and moral leadership.^a

That is the spirit in which the Select Committee sought to pursue its inquiry and that is the spirit in which the Committee puts forward the following analysis of the intelligence community and the operation of its constituent parts.

^a Clifford, 12/5/75, Hearings, p. 53.



III. THE CONSTITUTIONAL FRAMEWORK FOR INTELLIGENCE ACTIVITIES

A. THE JOINT RESPONSIBILITIES OF THE LEGISLATIVE AND EXECUTIVE BRANCHES—SEPARATION OF POWERS AND CHECKS AND BALANCES

While the Constitution contains no provisions expressly allocating authority for intelligence activity, the Constitution's provisions regarding foreign affairs and national defense are directly relevant. From the beginning, U.S. foreign intelligence activity¹ has been conducted in connection with our foreign relations and national defense.

In these areas, as in all aspects of our Government, the Constitution provides for a system of checks and balances under the separation of powers doctrine. In foreign affairs and national defense, Congress and the President were both given important powers. The Constitution, as Madison explained in *The Federalist*, established "a partial mixture of powers."² Unless the branches of government, Madison said, "be so far connected and blended as to give each a constitutional control over the others, the degree of separation which the maxim requires, as essential to a free government, can never in practice be maintained."³ The framers' underlying purpose, as Justice Brandeis pointed out, was "to preclude the exercise of arbitrary power."⁴

This pattern of checks and balances is reflected in the constitutional provisions with respect to foreign affairs and national defense. In foreign affairs, the President has the power to make treaties and to appoint Ambassadors and envoys, but this power is subject to the "advice and consent" of the Senate.⁵ While the President has the exclusive power to receive ambassadors from foreign states,⁶ the Congress has important powers of its own in foreign affairs, most notably the power to regulate foreign commerce and to lay duties.⁷

¹ A definition of the term "foreign intelligence activity" is necessary in order to properly assess the constitutional aspects of foreign intelligence activity. Foreign intelligence activity is now understood to include secret information gathering and covert action. Covert action is defined by the CIA as secret action designed to influence events abroad, including the use of political means or varying degrees of force. The political means can range from the employment of propaganda to large-scale efforts to finance foreign political parties or groups so as to influence elections or overthrow governments; covert action involving the use of force may include U.S. paramilitary operations or the support of military operations by foreign conventional or unconventional military organizations. (Memorandum from Mitchell Rogovin, Special Counsel to the Director of Central Intelligence, House Select Committee on Intelligence, Hearings, 12/9/75, p. 1789.)

² *The Federalist*, No. 47 (J. Madison).

³ *The Federalist*, No. 48 (J. Madison).

⁴ *Meyers v. United States*, 272 U.S. 52, 202 (1926).

⁵ United States Constitution, Article II, Section 2.

⁶ *Ibid.*, Sec. 3.

⁷ *Ibid.*, Art. I, Sec. 8.

In national defense, the President is made Commander-in-Chief, thereby having the power to command the armed forces, to direct military operations once Congress has declared war, and to repel sudden attacks.⁸ Congress, however, has the exclusive power to declare war, to raise and support the armed forces, to make rules for their government and regulation, to call forth the militia, to provide for the common defense, and to make appropriations for all national defense activities.⁹

Moreover, under the Necessary and Proper clause, the Constitution specifies that Congress shall have the power "to make all laws necessary and proper for carrying into execution" not only its own powers but also "all other powers vested by [the] Constitution in the Government of the United States, or in any Department or Officer thereof."¹⁰

This constitutional framework—animated by the checks and balances concept—makes clear that the Constitution contemplates that the judgment of both the Congress and the President will be applied to major decisions in foreign affairs and national defense. The President, the holder of "the executive power," conducts daily relations with other nations through the State Department and other agencies. The Senate, through its "advice and consent" power and through the work of its appropriate committees participates in foreign affairs. As Hamilton observed in *The Federalist*, foreign affairs should not be left to the "sole disposal" of the President:

The history of human conduct does not warrant that exalted opinion of human virtue which would make it wise to commit interests of so delicate and momentous a kind, as those which concern its intercourse with the rest of the world, to the sole disposal of a magistrate created and circumstanced as would be a President of the United States.¹¹

Similarly, in national defense, the constitutional framework is a "partial mixture of powers," calling for collaboration between the executive and the legislative branches. The Congress, through its exclusive power to declare war, alone decides whether the nation shall move from a state of peace to a state of war. While as Commander-in-Chief the President commands the armed forces, Congress is empowered "to make rules" for their "government and regulation."¹²

Moreover, in both the foreign affairs and defense fields, while the President makes executive decisions, the Congress with its exclusive power over the purse is charged with authority to determine whether, or to what extent, government activities in these areas shall be funded.¹³

The Constitution, while containing no express authority for the conduct of foreign intelligence activity, clearly endowed the Federal Government (i.e., Congress and the President jointly) with all the power necessary to conduct the nation's foreign affairs and national

⁸ *Ibid.*, Art. II, Sect. 2.

⁹ *Ibid.*, Sect. 8.

¹⁰ *Ibid.*

¹¹ *The Federalist*, No. 75 (A. Hamilton).

¹² United States Constitution, Article I, Section 8.

¹³ *Ibid.*, Art. II, Sect. 8.

defense and to stand on an equal basis with other sovereign states.¹⁴ Inasmuch as foreign intelligence activity is a part of the conduct of the United States' foreign affairs and national defense, as well as part of the practice of sovereign states, the Federal Government has the constitutional authority to undertake such activity in accordance with applicable norms of international law.^{15a}

We discuss below the manner in which Congress and the Executive branch have undertaken to exercise this federal power, and the consistency of their action with the Constitution's framework and system of checks and balances.

B. THE HISTORICAL PRACTICE

The National Security Act of 1947^{15b} was a landmark in the evolution of United States foreign intelligence. In the 1947 Act, Congress created the National Security Council and the CIA, giving both of these entities a statutory charter.

Prior to 1947, Congress, despite its substantial authority in foreign affairs and national defense, did not legislate directly with respect to foreign intelligence activity. Under the Necessary and Proper Clause, and its power to make rules and regulations for the Armed Forces, Congress might have elaborated specific statutes authorizing and regulating the conduct of foreign intelligence. In the absence of such statutes, Presidents conducted foreign intelligence activity prior to the 1947 National Security Act on their own authority.

In wartime, the President's power as Commander-in-Chief provided ample authority for both the secret gathering of information and covert action.^{15c} The authority to collect foreign intelligence information before 1947 in peacetime can be viewed as implied from the Presi-

¹⁴ As the Supreme Court has declared, "the United States, in their relation to foreign countries . . . are invested with the powers which belong to independent nations. . . ." [*Chinese Exclusion Case*, 130 U.S. 581, 604 (1889).]

^{15a} There are a number of international agreements which the United States has entered into which prohibit certain forms of intervention in the domestic affairs of foreign states. The Nations Charter in Article 2(4) obligates all U.N. members to "refrain in their international relations from the threat or use of force against the territorial integrity of any state." The Charter of the Organization of American States (OAS) in Article 18 provides:

"No State or group of States has the right to intervene, directly or indirectly for any reason whatever, in the internal or external affairs of any other State. The foregoing principle prohibits not only armed force but also any other form of interference or attempted threat against the personality of the State or against its political, economic, and cultural elements."

Under the Supremacy Clause of the Constitution (Art. VI, Sec. 2), treaty obligations of the United States are part of the law of the land. While the general principles of such treaties have not been spelled out in specific rules of application, and much depends on the facts of particular cases as well as other principles of international law (including the right of self-preservation, and the right to assist states against prior foreign intervention) it is clear that the norms of international law are relevant in assessing the legal and constitutional aspects of covert action.

^{15b} 50 U.S.C. 430.

^{15c} In *Totten v. United States*, 92 U.S. 105 (1875), the Supreme Court upheld the authority of the President to hire, without statutory authority, a secret agent for intelligence purposes during the Civil War. Authority for wartime covert action can be implied from the President's powers as Commander-in-Chief to conduct military operations in a war declared by Congress. Compare, *Totten v. United States*.

dent's power to conduct foreign affairs.¹⁶ In addition to the more or less discreet gathering of information by the regular diplomatic service, the President sometimes used specially-appointed "executive agents" to secretly gather information abroad.¹⁷ In addition, executive agents were on occasion given secret political missions that were similar to modern day political covert action.¹⁸ These, however, tended to be in the form of relatively small-scale responses to particular concerns, rather than the continuous, institutionalized activity that marked the character of covert action in the period after the passage of the 1947 National Security Act. There were no precedents for the peacetime use of covert action involving the use of armed force of the type conducted after 1947.

1. Foreign Intelligence and the President's Foreign Affairs Power

Although the Constitution provides that the President "shall appoint ambassadors, other public ministers and consuls" only "by and with the advice and consent of the Senate," beginning with Washington Presidents have appointed special envoys to carry out both overt diplomatic functions and foreign intelligence missions.¹⁹ The great majority of these envoys were sent on overt missions, such as to negotiate treaties or to represent the United States at international conferences. Some, however, were sent in secrecy to carry out the near equivalent of modern-day intelligence collection and covert political action. For example, in connection with U.S. territorial designs on central and western Canada in 1869, President Grant's Secretary of State sent a private citizen to that area to investigate and promote the possibility of annexation to the United States.²⁰

Presidential discretion as to the appointment of such executive agents derived from the President's assumption of the conduct of foreign relations. From the beginning, the President represented the United States to the world and had exclusive charge of the channels and processes of communication. The President's role as "sole organ" of the nation in dealing with foreign states was recognized by John Marshall in 1816²¹ and reflected the views expressed in *The Federalist*

¹⁶ Compare, *United States v. Butenko* 404 F.2d 593 (3d Cir. 1974): "Decisions affecting the United States' relationship with other sovereign states are more likely to advance our national interests if the President is apprised of the intentions, capabilities and possible responses of other countries."

¹⁷ Henry Wriston, *Executive Agents in American Foreign Relations*, (1929, 1967).

¹⁸ *Ibid.*, pp. 603, et. seq.

¹⁹ The first such specially-appointed individual was Gouverneur Morris, sent by President Washington in 1780 as a "private agent" to Britain to explore the possibilities for opening normal diplomatic relations. Morris was appointed in October 1780 because Washington's Secretary of State, Jefferson, was not yet functioning. The mission was not reported to the Congress until February 1791. Henry Wriston, "The Special Envoy," *Foreign Affairs*, 38 (1960), pp. 210, 220)

²⁰ Wriston, *Executive Agents in American Foreign Relations*, p. 739.

²¹ Marshall spoke, not as Chief Justice in an opinion of the Supreme Court, but rather in a statement to the House of Representatives. The House of Representatives was engaged in a debate as to whether a demand by the British Government for the extradition of one Robbins was a matter for the courts or for the President, acting upon an extradition treaty. Marshall argued that the case involved "a national demand made upon the nation." Since the President is the "sole organ of the nation in its external relations" Marshall said, "of consequence, the demand can only be made upon him." [10 Annals of Congress 613 (1800), reprinted in 5 Wheat, Appendix, Note 1, at 26 (U.S. 1820).]

that the characteristics of the Presidency—unity, secrecy, decision, dispatch—were especially suited to the conduct of diplomacy.²² As a consequence, historical development saw the President take charge of the daily conduct of foreign affairs, including the formulation of much of the nation's foreign policy. But "sole organ" as to communications with foreign governments and historical practice did not amount to "sole disposal" in a constitutional sense over foreign affairs; as Hamilton declared, the Constitution did not grant that degree of power to the President in foreign affairs.²³ Moreover, Marshall's reference to the President as "sole organ" did not purport to mean that the President was not subject to congressional regulation, should Congress wish to act. For Marshall, in addition to speaking of the President as "sole organ," went on to point out that "Congress, unquestionably, may prescribe the mode" by which such power to act was to be exercised.²⁴ Congress, with its own constitutional powers in foreign affairs, its power over the purse, and under the authority contained in the Necessary and Proper Clause, had the option of regulating the practice of using executive agents on foreign intelligence missions, as well as the conduct of foreign intelligence activity by other means.²⁵

2. The Use of Force in Covert Action

Covert action may include the use of armed force. In modern times, the President's authorization of the CIA-financed and directed invasion of Cuba at the Bay of Pigs and paramilitary operations in Laos are examples of this type of covert action.

²² Nor did Marshall intend to say that "sole organ" meant the power of "sole disposal." As the eminent constitutional expert Edward S. Corwin wrote, "Clearly, what Marshall had foremost in mind was simply the President's role as instrument of communication with other governments." (Edward S. Corwin, *The President's Control of Foreign Relations*, p. 216.)

²³ *The Federalist*, No. 75 (A. Hamilton).

²⁴ Citing Marshall's expression, the Supreme Court has recognized the President as "sole organ" of communication and negotiation in foreign affairs. [*United States v. Curtiss-Wright Export Corp.*, 299 U.S. 304 (1952).] Although dicta of Justice Sutherland in the *Curtiss-Wright* opinion put forward a broad view of "inherent" Presidential power in foreign affairs, the case and the holding of the court involved, as Justice Jackson stated in his opinion in the *Steel Seizure* case, "not the question of the President's power to act without congressional authority, but the question of his right to act under and in accord with an Act of Congress." [*Youngstown Steel & Tube Co. v. Sawyer*, 343 U.S. 579, 635-636 (1952) (concurring opinion).]

In *Curtiss-Wright* a joint resolution of Congress had authorized the President to embargo weapons to countries at war in the Chaco, and imposed criminal sanctions for any violation. After President Franklin D. Roosevelt proclaimed an embargo, the Curtiss-Wright Corporation, indicted for violating the embargo, challenged the congressional resolution and the President's proclamation, claiming Congress had made an improper delegation of legislative power to the President. Speaking for six justices, Justice Sutherland sustained the indictment, holding only, as Justice Jackson later noted, "that the strict limitation upon Congressional delegations of power to the President over internal affairs does not apply with respect to delegations of power in external affairs." (343 U.S. at 636.)

²⁵ In 1793, for example, Congress established a procedure for the financing of secret foreign affairs operations. It enacted a statute providing for expenses of "intercourse or treaty" with foreign nations. The Act required the President to report all such expenditures, but granted him the power to give a certificate in lieu of a report for those payments the President deemed should be kept secret. (Act of February 9, 1793, 1 Stat. 300.)

The executive branch relies in large part on the President's own constitutional powers for authority to conduct such covert action.²⁶ After the failure of the Bay of Pigs operation in 1961, the CIA asked the Justice Department for an analysis of the legal authority for covert actions. In its response, the Justice Department's Office of Legislative Council stated:

It would appear that the executive branch, under the direction of the President, has been exercising without express statutory authorization a function which is within the constitutional powers of the President, and that the CIA was the agent selected by the President to carry out these functions.²⁷

The Justice Department memorandum pointed to the President's foreign relations power and his responsibility for national security.²⁸ Arguing by analogy from the President's power as Commander-in-Chief to conduct a declared war, the memorandum contended that the President could conduct peacetime covert actions involving armed force without authority from Congress. The memorandum argued that there was no limit to the means the President might employ in exercising his foreign affairs power:

Just as "the power to wage war is the power to wage war successfully," so the power of the President to conduct foreign relations should be deemed to be the power to conduct foreign relations successfully, *by any means necessary* to combat the measures taken by the Communist bloc, including both open and covert measures.²⁹ [Emphasis added.]

In view of the Constitution's grant of concurrent jurisdiction to the Congress in foreign affairs and Congress' exclusive constitutional authority to declare war, there is little to support such an extravagant claim of Presidential power in peacetime. The case which prompted the Justice Department's argument—the invasion of Cuba at the Bay

²⁶ In September 1947, the CIA General Counsel expressed the opinion that activity such as "black propaganda, ranger and commando raids, behind-the-lines sabotage, and support of guerrilla warfare" would constitute "an unwarranted extension of the functions authorized" by the 1947 Act. (Memorandum from the CIA General Counsel to Director, 9/25/47.) And, in 1960, the CIA General Counsel wrote that the 1947 Act provided "rather doubtful statutory authority" for at least those covert actions—such as paramilitary operations—which were not related to intelligence gathering. (Memorandum from CIA General Counsel to Director, 10/30/60.) The Agency's General Counsel took the position that the authority for covert action rested on the President's delegation of his own constitutional authority to CIA through various National Security Council Directives. (Ibid.)

²⁷ Memorandum, Office of Legislative Counsel, Department of Justice, 1/17/62, p. 11.

²⁸ *Ibid.*, p. 7. The memorandum stated:

"Under modern conditions of 'cold war,' the President can properly regard the conduct of covert activities . . . as necessary to the effective and successful conduct of foreign relations and the protection of the national security. When the United States is attacked from without or within, the President may 'meet force with force' . . . In waging a worldwide contest to strengthen the free nations and contain the Communist nations, and thereby to preserve the existence of the United States, the President should be deemed to have comparable authority to meet covert activities with covert activities if he deems such action necessary and consistent with our national objectives."

²⁹ *Ibid.*

of Pigs—illustrates the serious constitutional questions which arise. In that operation, the President in effect authorized the CIA to secretly direct and finance the military invasion of a foreign country. This action approached, and may have constituted, an act of war. At the least, it seriously risked placing the United States in a state of war *vis-à-vis* Cuba on the sole authority of the President. Absent the threat of sudden attack or a grave and immediate threat to the security of the country, only Congress, under the Constitution, has such authority. As James Madison declared, Congress' power to declare war includes the "power of judging the causes of war."³⁰ Madison wrote:

Every just view that can be taken of the subject admonishes the public of the necessity of a rigid adherence to the simple, the received, and the fundamental doctrine of the constitution, that the power to declare war, including the power of judging the causes of war, is fully and exclusively vested in the legislature. . . ."³¹

This view was also affirmed by Hamilton who, although a principal exponent of expansive Presidential power, wrote that it is the

exclusive province of Congress, when the nation is at peace, to change that state into a state of war . . . it belongs to Congress only, to go to war.³²

Nor is there much support in historical practice prior to 1950 for the use of armed force to achieve foreign policy objectives on the sole authority of the President. The 1962 Justice Department memorandum argued that the practice of Presidents in using force to protect American citizens and property abroad was authority for covert action involving armed force.³³ Before the post-World War II era, Presidents on occasion asserted their own authority to use armed force short of war, but as the Senate Committee on Foreign Relations noted in 1973, these operations were for "limited, minor, or essentially non-political purposes." As the Foreign Relations Committee stated:

During the course of the nineteenth century it became accepted practice, if not strict constitutional doctrine, for Presidents acting on their own authority to use the armed forces for such limited purposes as the suppression of piracy and the slave trade, for "hot pursuit" of criminals across borders, and for the protection of American lives and property in places abroad where local government was not functioning effectively. An informal, operative distinction came to be accepted between the use of the armed forces for limited, minor or essentially nonpolitical purposes and the use of the armed forces for "acts of war" in the sense of large-scale military operations against sovereign states.³⁴

That these operations were, as the Committee on Foreign Relations noted, for "limited, minor, or essentially non-political purposes" is also

³⁰ *Letters of Helvidius* (1793), Madison, *Writings*, Vol. 6, p. 174 (Hunt ed.).

³¹ *Ibid.*

³² Hamilton, *Works*, Vol. 8, pp. 249-250 (Lodge ed.)

³³ Justice Department Memorandum, 1/17/62, p. 2.

³⁴ Senate Report No. 220, 93d Cong., 1st Sess. (1973).

affirmed by the eminent authority on constitutional law, Edward Corwin. Prior to the Korean War, the "vast majority" of such cases, Corwin wrote, "involved fights with pirates, landings of small naval contingents on barbarous coasts [to protect American citizens], the dispatch of small bodies of troops to chase bandits or cattle rustlers across the Mexican border."³⁵

To stretch the President's foreign relations power so far as to authorize the secret use of armed force against foreign states without congressional authorization or at least "advice and consent," appears to go well beyond the proper scope of the Executive's power in foreign affairs under the Constitution. Moreover, where Congress is not informed prior to the initiation of such armed covert action—as it was not, for example, in the Bay of Pigs operation—the constitutional system of checks and balances can be frustrated. Without prior notice, there can be no effective check on the action of the executive branch. Once covert actions involving armed force, such as the invasion of Cuba at the Bay of Pigs or paramilitary operations, are begun, it may be difficult if not impossible for practical reasons to stop them. In such circumstances, covert action involving armed intervention in the affairs of foreign states may be inconsistent with our constitutional system and its principle of checks and balances.

C. THE CONSTITUTIONAL POWER OF CONGRESS TO REGULATE THE CONDUCT OF FOREIGN INTELLIGENCE ACTIVITY

Prior to the 1947 National Security Act, Congress did not seek to expressly authorize or regulate foreign intelligence activity by statute.

Congress' decision not to act, however, did not reduce or eliminate its constitutional power to do so in the future. The Necessary and Proper Clause and its power to "make rules for the government and regulation" of the armed forces, along with Congress' general powers in the fields of foreign affairs and national defense, were always available.

In this light, the question of the legal authority for the conduct of foreign intelligence activity in the absence of express statutory authorization can be viewed in the manner set forth by Justice Jackson in the *Steel Seizure* case. He wrote:

When the President acts in absence of either a congressional grant or denial of authority, he can only rely upon his own independent powers, but there is a zone of twilight in which he and Congress may have concurrent authority, or in which its distribution is uncertain. Therefore, congressional inertia, indifference or quiescence may sometimes, at least as a practical matter, enable, if not invite, measures on independent Presidential responsibility.³⁶

Foreign intelligence activity, particularly political covert action not involving the use of force, can be seen as lying in such a "zone of twilight" in which both the President and the Congress have concurrent authority and responsibilities. (As discussed above, the use of covert

³⁵ Edward S. Corwin, "The President's Power," in Haight and Johnson, eds. *The President's Role and Powers*, (1905), p. 301.

³⁶ *Youngstown Co. v. Sawyer*, 343 U.S. 570, 637 (1952) (concurring opinion).

action involving armed force raises serious constitutional problems where it is not authorized by statute, particularly if Congress is not informed.) When Congress does not act, the President may in certain circumstances exercise authority on the basis of his own constitutional powers.

Congress can, however, choose to exercise its legislative authority to regulate the exercise of that authority. In view of the President's own constitutional powers, Congress may not deprive the President of the function of foreign intelligence. But, as Chief Justice Marshall stated, Congress can "prescribe the mode" by which the President carries out that function. And the Congress may apply certain limits or controls upon the President's discretion.

The Supreme Court has affirmed this constitutional power of Congress. In *Little v. Barreme*,³⁷ Chief Justice Marshall, speaking for the Court, found the seizure by the U.S. Navy of a ship departing a French port to be unlawful, even though the Navy acted pursuant to Presidential order. By prior statute, Congress had authorized the seizure of ships by the Navy, but limited the types of seizures that could be made. The President's orders to the Navy disregarded the limits set out in the law. If Congress had been silent, Chief Justice Marshall stated, the President's authority as Commander-in-Chief might have been sufficient to permit the seizure. But, Marshall declared, once Congress had "prescribed . . . the manner in which this law shall be carried into execution," the President was bound to respect the limitations imposed by Congress.³⁸

There have been at least as many conceptions of the range of the President's own power as there have been holders of the office of the President. In the case of foreign intelligence activity, Justice Jackson's statement that "comprehensive and undefined Presidential powers hold both practical advantages and grave dangers for the country"³⁹ is particularly relevant, especially in view of the tension between the need for secrecy and the constitutional principle of checks and balances. Yet, as Justice Brandeis declared, "checks and balances were established in order that this should be a government of laws and not of men."⁴⁰

The 1947 National Security Act represented the exercise of Congress' constitutional power to order the conduct of foreign intelligence activity under law. By placing the authority for foreign intelligence activity on a statutory base, Congress sought to reduce the reliance on "comprehensive and undefined" Presidential power that had previously been the principal source of authority. However, the language of the 1947 Act did not expressly authorize the conduct of covert action and, as discussed earlier, Congress apparently did not intend to grant such authority. As a result, inherent Presidential power has continued to serve as the principal source of authority for covert action.

Congress continued to exercise this constitutional power in subsequent legislation. In the Central Intelligence Act of 1949,⁴¹ Congress

³⁷ 2 Cranch 170 (1805).

³⁸ 2 Cranch 170, 178 (1805).

³⁹ *Youngstown Co. v. Sawyer*, 343 U.S. 579, 634 (1952) (concurring opinion).

⁴⁰ *Myers v. United States*, 272 U.S. 52, 202 (1926) (dissenting opinion).

⁴¹ 50 U.S.C. 403a-403j.

set out the administrative procedures governing CIA activities. The 1949 Act regulated the CIA's acquisition of material, the hiring of personnel and its accounting for funds expended.

In 1974, Congress imposed a reporting requirement for the conduct of certain foreign intelligence activities. In an amendment to the Foreign Assistance Act,⁴² Congress provided that no funds may be expended by or on behalf of the CIA for operations abroad "other than activities intended solely for obtaining necessary intelligence" unless two conditions were met: a) the President must make a finding that "each such operation is important to the national security of the United States", and b) the President must report "in a timely fashion" a description of such operation and its scope to congressional committees.⁴³

In short, the Constitution provides for a system of checks and balances and interdependent power as between the Congress and the executive branch with respect to foreign intelligence activity. Congress, with its responsibility for the purse and as the holder of the legislative power, has the constitutional authority to regulate the conduct of foreign intelligence activity.

⁴² 22 U.S.C. 2422.

⁴³ *Ibid.*

IV. THE PRESIDENT'S OFFICE

Intelligence has been the province of the President. It has informed his decisions and furthered his purposes. Intelligence information has been seen as largely belonging to the President, as being his to classify or declassify, his to withhold or share. The instruments of U.S. intelligence have been the Presidents' to use and sometimes to abuse.

The President is the only elected official in the chain of command over the United States intelligence community. It is to him the Constitution and the Congress have granted authority to carry out intelligence activities. It is the President who is ultimately accountable to the Congress and the American people.

The Committee focused its investigation on the instruments available to the President to control, direct, and supervise the U.S. intelligence community. As the result of controversy as to whether the intelligence community has been "out of control," Senate Resolution 21 directed the Committee to determine the "nature and extent of executive branch oversight of all United States intelligence activities."

This involves three Presidential instrumentalities:¹

- The National Security Council;
- The Office of Management and Budget;
- The President's Foreign Intelligence Advisory Board.

The Committee sought to establish whether these mechanisms, as they have evolved, provide effective control over the entire range of U.S. intelligence activities. Particular attention was given to the subject of covert action, in part because it has been a major object of presidential-level review. In addition, the Committee considered the adequacy of high-level supervision of espionage, counterintelligence, and the overall management of the U.S. intelligence community. For the first time in the history of congressional oversight, the Committee had access to records of the proceedings of the National Security Council and its subcommittees. It reviewed the NSC directives related to intelligence and the files of other agencies' participation in the NSC's intelligence-related activities. The Committee conducted extensive interviews with current and former White House, NSC, and cabinet-level officials dealing with intelligence matters. It took sworn testimony on these issues from a number of them, including the present Secretary of State. Officials of the Office of Management and Budget and former members and staff of the President's Foreign Intelligence Advisory Board were also interviewed.

This report presents the results of that investigation and the Committee's findings with respect to the central question of Presidential accountability and control of the foreign intelligence activities of the United States Government.

¹ A fourth instrumentality has been established as a result of President Ford's February 17, 1976, reorganization of the foreign intelligence community. Executive Order 11905 created the Intelligence Oversight Board.

A. THE NATIONAL SECURITY COUNCIL

1. Overview

The National Security Council was created by the National Security Act of 1947. According to the Act, the NSC is "to advise the President with respect to the integration of domestic, foreign, and military policies relating to national security" and "assess and appraise the objectives, commitments, and risks of the United States in relation to our actual and potential military power." Over the years, the principal functions of the NSC have been in the field of policy formulation and the coordination and monitoring of overseas operations. Among its responsibilities, the NSC has provided policy guidance and direction for United States intelligence activities.

The National Security Council is an extremely flexible instrument. It has only four statutory members: the President, the Vice President, and the Secretaries of State and Defense. At the discretion of the President, others may be added to the list of attendees; NSC subcommittees may be created or abolished, and the NSC staff given great power or allowed to wither.

Thus, the operation of the NSC has reflected the personal style of each President. The Council's role and responsibilities have varied according to personalities, changing policies and special circumstances. Presidents Truman, Kennedy and Johnson found a loose and informal NSC structure to their liking. Others have set up more formal and elaborate structures—President Eisenhower's NSC system is the best example.² At times, particularly during crises, Presidents have bypassed the formal NSC mechanisms. President Kennedy set up an Executive Committee (EXCOM) to deal with the Cuban Missile Crisis; President Johnson had his Tuesday Lunch group to discuss Viet Nam and other high level concerns. As a result, over the years the NSC has undergone major changes, from the elaborate Planning Board/Operations Coordination Board structure under Eisenhower to its dismantlement by Kennedy and the creation of a centralized system of NSC subcommittees under President Nixon and his Assistant for National Security Affairs, Dr. Kissinger.

Today, in addition to the four statutory members, the National Security Council is attended by the Director of Central Intelligence (DCI) and the Chairman of the Joint Chiefs of Staff as advisers. From time to time, others, such as the Director of the Arms Control and Disarmament Agency, also attend.

Prior to President Ford's reorganization, the NSC was served by seven principal committees: the Senior Review Group, the Under Secretary's Committee, the Verification Panel, the Washington Special Actions Group (WSAG), the Defense Program Review Committee, the 40 Committee, and the National Security Council Intelligence

² For a full treatment of the evolution of the National Security Council and its place within the national security decisionmaking process, see Keith Clark and Laurence Logere, *The President and the Management of National Security* (1969); Stanley Falk and Theodore Bauer, *National Security Management: The National Security Structure* (1972); and Inquiries of the Subcommittee on National Policy Machinery for the Senate Committee on Government Operations, *Organizing for National Security* (1961).

Committee (NSCIC).³ The latter two committees had direct intelligence responsibilities. The 40 Committee has now been replaced by the Operations Advisory Group. No successor for NSCIC has been designated. The current NSC structure is shown below.

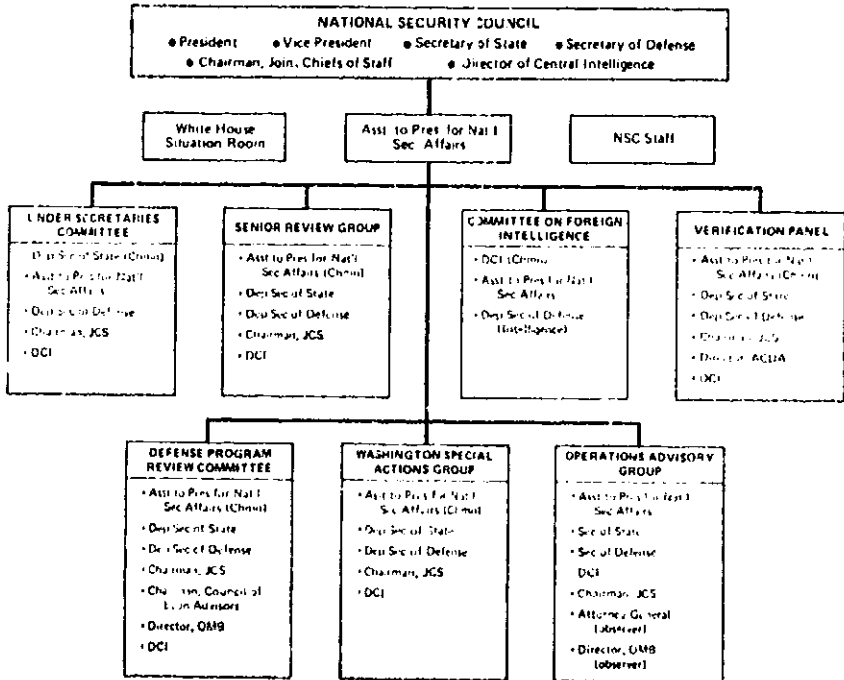

Each of the current NSC subcommittees are "consumers" of the intelligence community product. The DCI sits on all of them. In most cases, the DCI briefs the subcommittees and the full NSC before agenda items are considered. CIA representatives sit on working and ad hoc groups of the various subcommittees. The CIA's Area Division Chiefs are the Agency's representatives on the NSC Interdepartmental Groups (IGs).⁴ In all of these meetings there is a constant give and take. Policymakers are briefed on current intelligence and they, in turn, levy intelligence priorities on the CIA's representatives.

³The Senior Review Group, under the direction of the President's Assistant for National Security Affairs defines NSC issues; determines whether alternatives, costs, and consequences have been fully considered; and forwards recommendations to the full Council and/or the President. The Under Secretaries Committee seeks to ensure effective implementation of NSC decisions. The Verification Panel monitors arms control agreements and advises on SALT and MBR negotiations. WASG coordinates activities during times of crises, such as the Middle East and Southeast Asia. The Defense Program Review Committee, now nearly defunct, assesses the political, military and economic implications of defense policies and programs.

⁴NSC Interdepartmental Groups (IGs) are made up of representatives from State, Defense, CIA, the Joint Chiefs of Staff and the National Security Council. IGs are chaired by the State representative, an Assistant Secretary, and they prepare working papers for the Senior Review Group.

2. *The NSC and Intelligence*

The 1947 National Security Act established the CIA as well as the NSC. The Act provided that the CIA was "established under the National Security Council" and was to carry out its prescribed functions "under the direction of the National Security Council." Five broad functions were assigned to the CIA:

(1) *to advise* the National Security Council in matters concerning such intelligence activities of the Government departments and agencies as relate to national security.

(2) *to make recommendations* to the National Security Council for the coordination of such intelligence activities of the departments and agencies of the Government as relate to the national security;

(3) *to correlate and evaluate* intelligence relating to the national security, and provide for the appropriate dissemination of such intelligence within the Government using where appropriate existing agencies and facilities.

(4) *to perform*, for the benefit of the existing intelligence agencies, *such additional services of common concern* as the National Security Council determines can be more efficiently accomplished centrally.

(5) *to perform such other functions and duties* related to intelligence affecting the national security as the National Security Council may from time to time direct.

The Director of Central Intelligence is responsible for seeing that these functions are performed, and is to serve as the President's principal foreign intelligence officer.

The NSC sets overall policy for the intelligence community. It does not, however, involve itself in day-to-day management activities. The task of coordinating intelligence community activities has been delegated to the DCI, who, until President Ford's reorganization, sought to accomplish it through the United States Intelligence Board (USIB). USIB was served by 15 inter-agency committees and a variety of ad hoc groups. It provided guidance to the intelligence community on requirements and priorities, coordinated community activities and issued, through the DCI, National Intelligence Estimates (NIEs). The DCI was also assisted by the Intelligence Resources Advisory Committee (IRAC). IRAC assisted the DCI in the preparation of a consolidated intelligence budget and sought to assure that intelligence resources were being used efficiently.

As a result of President Ford's Executive Order, management of the intelligence community will now be vested in the Committee on Foreign Intelligence (CFI). USIB and IRAC are abolished. Membership on the new committee will include the DCI, as Chairman, the Deputy Secretary of Defense for Intelligence and the Deputy Assistant to the President for National Security Affairs. Staff support will be provided by the DCI's Intelligence Community (IC) staff. The new committee will report directly to the NSC.

The CFI will have far-ranging responsibilities. It will oversee the budget and resources, as well as establish management policies, for the CIA, the National Security Agency, the Defense Intelligence Agency,

and United States reconnaissance programs. Further, it will establish policy priorities for the collection and production of national intelligence. The DCI will be responsible for producing national intelligence, including NIEs. To assist him in this task, the DCI will set up whatever boards and committees (similar to the now defunct USIB) are necessary.

The President's Executive Order also directed the NSC to review, on a semi-annual basis, certain foreign intelligence activities. Prepared by the President's Assistant for National Security Affairs, these reviews will focus on the quality, scope and timeliness of the intelligence product; the responsiveness of the intelligence community to policy-makers' needs; the allocation of intelligence collection resources; and the continued appropriateness of ongoing covert operations and sensitive intelligence collection missions.

One of the functions the NSC has assigned to the CIA is the conduct of foreign covert operations. These operations began in 1948 and have continued to the present, uninterrupted. Authority to conduct covert operations has usually been ascribed to the "such other functions and duties" provision of the 1947 Act.³

The NSC uses National Security Council Intelligence Directives (NSCIDs) to set policy for the CIA and the intelligence community. NSCIDs are broad delegations of responsibility, issued under the authority of the 1947 Act.⁴ They may assign duties not explicitly stated in the 1947 Act to the CIA or other intelligence departments or agencies. NSCIDs, sometimes referred to by critics as the intelligence community's "secret charter," are executive directives and, therefore, not subject to congressional review. Until recently, Congress has not seen the various NSCIDs issued by the NSC.

3. Overview: 40 Committee and NSCIC

Prior to President Ford's reorganization, two NSC committees, the 40 Committee and the National Security Council Intelligence Committee, had special intelligence duties. Their functions and responsibilities will be discussed in turn.

Throughout its history, the 40 Committee and its direct predecessors—the 303 Committee, the 5412 or Special Group, the 10/5 and 10/2 Panels—have been charged by various NSC directives with exercising political control over foreign covert operations.⁵ Now this task will be the responsibility of the Operations Advisory Group. The Committees have considered the objectives of any proposed activity,

³ Three possible legal bases for covert operations are most often cited: the National Security Act of 1947, the "inherent powers" of the President in foreign affairs and as Commander-in-Chief, and the Foreign Assistance Act of 1974. Congressional acquiescence and ratification through the appropriations process is a fourth possibility. See Appendix I of this report for a full discussion.

⁴ For example, NSCIDs are used to spell out the duties and responsibilities of the DCI, the coordination of covert intelligence collection activities, and the production and dissemination of the intelligence community product.

⁵ Covert operations encompass a wide range of programs. These include political and propaganda programs designed to influence or support foreign political parties, groups, and specific political and military leaders; economic action programs; paramilitary operations; and some counterinsurgency programs. Human intelligence collection, or spying, and counterespionage programs are not included under the rubric of covert operations.

whether the activity would accomplish those aims, how likely it would be to succeed, and in general whether the activity would be in the American interest. In addition, the Committees have attempted to insure that covert operations were framed in such a way that they later could be "disavowed" or "plausibly denied" by the United States Government. President Ford's Executive Order included the concept of "plausible denial." Using the euphemism "special activities" to describe covert operations, the Order stated:

Special activities in support of national foreign policy objectives [are those] activities . . . designed to further official United States programs and policies abroad which are planned and executed so that the role of the United States Government is not apparent or publicly acknowledged.^{7a}

The concept of "plausible denial" is intended not only to hide the hand of the United States Government, but to protect the President from the embarrassment of a "blown" covert operation. In the words of former CIA Director Richard Helms:

. . . [the] Special Group was the mechanism . . . set up . . . to use as a circuit-breaker so that these things did not explode in the President's face and so that he was not held responsible for them.^{7b}

In the past, it appears that one means of protecting the President from embarrassment was not to tell him about certain covert operations, at least formally. According to Bromley Smith, an official who served on the National Security Council staff from 1958 to 1969, the concept of "plausible denial" was taken in an almost literal sense: "The government was authorized to do certain things that the President was not advised of."^{7c} According to Secretary of State Kissinger, however, this practice was not followed during the Nixon Administration and he doubted it ever was. In an exchange with a member of the House Select Committee on Intelligence, Secretary Kissinger stated:

Mr. KASTEN. Mr. Secretary, you said that the President personally, directly approved all of the covert operations during that period of time [1972 to 1974] and, in your knowledge, during all periods of time. Is that correct?

Secretary KISSINGER. I can say with certainty during the period of time that I have been in Washington and to my almost certain knowledge at every period of time, yes.⁸

Four senior officials who deal almost exclusively with foreign affairs have been central to each of the sequence of committees charged with considering covert operations: The President's Assistant for National Security Affairs, the Deputy Secretary of Defense, the Under Secretary of State for Political Affairs (formerly the Deputy Under Secretary), and the Director of Central Intelligence. These four officials, plus the Chairman of the Joint Chiefs of Staff, made up the 40 Com-

^{7a} Executive Order No. 11905, 2/18/76.

^{7b} Richard Helms testimony, 6/13/75, pp. 28-29.

^{7c} Staff summary of Bromley Smith interview, 5/5/76.

⁸ Henry Kissinger testimony, House Select Committee on Intelligence, Hearings, 10/31/76, p. 8841.

mittee. At certain times the Attorney General also sat on the Committee. President Ford's reorganization will significantly alter this membership. The new Operations Advisory Group will consist of the President's Assistant for National Security Affairs, the Secretaries of State and Defense, the Chairman of the JCS, and the DCI. The Attorney General and the Director of OMB will attend meetings as observers. The Chairman of the Group will be designated by the President. Staff support will be provided by the NSC staff.

The formal composition of the Operations Group breaks with tradition. The Secretaries of State and Defense will now be part of the approval process for covert operations, rather than the Under Secretary of State for Political Affairs and Deputy Secretary of Defense. The Operations Advisory Group appears to be, therefore, an up-graded 40 Committee. Whether this proves to be the case remains to be seen. President Ford's Executive Order contained a provision, Section 3(c) (3), which allows Group members to send a "designated representative" to meetings in "unusual circumstances."

The National Security Council Intelligence Committee (NSCIC) was established in November 1971 as part of a far-reaching reorganization of the intelligence community ordered by President Nixon.⁹ The Presidential directive stated:

The Committee will give direction and guidance on national intelligence needs and provide for a continuing evaluation of intelligence products from the viewpoint of the intelligence user.

One reason cited for creating NSCIC was a desire to make the intelligence community more responsive to the needs of policy makers. According to a news report at the time:

"The President and Henry [Kissinger] have felt that the intelligence we were collecting wasn't always responsive to their needs," said one source. "They suspected that one reason was because the intelligence community had no way of knowing day to day what the President and Kissinger needed. This is a new link between producers and consumers. We'll have to wait and see if it works."¹⁰

Prior to NSCIC no formal structure existed for addressing the major questions concerning intelligence priorities rather than specific operations: Do "producers" in the intelligence community perform analyses which are useful to "consumers"—the policymakers at various levels of government; are intelligence resources allocated wisely

⁹ For over a year, the intelligence community had been under study by the Office of Management and Budget, then headed by James Schlesinger. In addition to NSCIC, the President's reorganization included an enhanced leadership role for the DCI, the establishment of a Net Assessment Group within the NSC staff, the creation of an Intelligence Resources Advisory Committee (IRAC), and a reconstitution of the United States Intelligence Board (USIB). The Net Assessment Group was headed by a senior NSC staff member and was responsible for reviewing and evaluating all intelligence products and for producing net assessments. When James Schlesinger was named Secretary of Defense in June, 1973, the NSC Net Assessment Group was abolished. Its staff member joined Schlesinger at the Defense Department and set up a similar office.

¹⁰ "Helms Told to Cut Global Expenses," *New York Times*, 11/7/71, p. 55.

among agencies and types of collection? NSCIC was a structural response to these issues as well as part of the general tendency at that time to centralize a greater measure of control in the White House for national security affairs.

NSCIC's mission was to give direction and policy guidance to the intelligence community. It was not, and was not intended to be, a channel for transmitting substantive intelligence from the intelligence community to policymakers nor for levying specific requirements in the opposite direction. Neither was NSCIC involved in the process of allocating intelligence resources. Its membership included the Assistant to the President for National Security Affairs, who chaired the Committee, the DCI, the Deputy Secretaries of State and Defense, the Chairman of the JCS, and the Under Secretary of the Treasury for Monetary Affairs.

NSCIC was abolished by Executive Order 11905. No successor body was created. The task of providing policy guidance and direction to the intelligence community now falls to the Committee on Foreign Intelligence. According to the President's Executive Order, the CFI will "establish policy priorities for the collection and production of national intelligence." In addition, the full NSC is now required to conduct policy reviews twice a year on the quality, scope and timeliness of intelligence and on the responsiveness of the intelligence community to the needs of policymakers.

B. AUTHORIZATION AND CONTROL OF COVERT ACTIVITIES

1. *The NSC and Covert Activities: History*

President Ford's Operations Advisory Group is the most recent in a long line of executive committees set up to oversee CIA covert activities. These committees and CIA covert activities can be traced back to NSC-4-A, a National Security Council directive issued in December 1947.

In 1947 the United States was engaged in a new struggle, the Cold War. To resist Communist-backed civil war in Greece, the Truman Doctrine was proclaimed. The Marshall Plan was about to begin. Within three years China would "fall," the Korean War would begin, and the Soviet Union would acquire an atomic capability. The Cold War was being fought on two fronts—one overt, the other covert. The Soviet clandestine services, then known as the NKVD (now the KGB), were engaged in espionage and subversive activities throughout the world. France and Italy were beleaguered by a wave of Communist-inspired strikes. In February 1948, the Communists staged a successful coup in Czechoslovakia. The Philippines government was under attack by the Hukbalahaps, a Communist-led guerrilla group. In that climate, and in response to it, a broad range of United States covert activities were begun. They were intended to supplement not replace, overt U.S. activities, such as the Marshall Plan.

In December 1947, the Department of State advised the National Security Council that covert operations mounted by the Soviet Union threatened the defeat of American objectives and recommended that the United States supplement its own overt foreign policy activities with covert operations. At the Council's first meeting, on December 19, 1947, it approved NSC-4, entitled "Coordination of Foreign Intelli-

gence Information Measures." This directive empowered the Secretary of State to coordinate overseas information activities designed to counter communism. A top secret annex to NSC-4—NSC-4-A—instructed the Director of Central Intelligence to undertake covert psychological activities in pursuit of the aims set forth in NSC-4. The initial authority given the CIA for covert operations under NSC-4-A did not establish formal procedures for either coordinating or approving these operations. It simply directed the DCI to undertake covert action and to ensure, through liaison with State and Defense, that the resulting operations were consistent with American policy. In 1948, an independent CIA office—the Office of Policy Coordination (OPC)—was established to carry out the covert mission assigned by the NSC. NSC-4-A was the President's first formal authorization for covert operations in the postwar period,¹¹ and it was used to undertake covert attempts to influence the outcome of the 1948 Italian national elections.

Over the next seven years, from June 1948 to March 1955, a series of National Security Council directives was issued. Each was addressed, in part, to the review and control of CIA covert activities. NSC 10/2 superseded NSC-4-A on June 18, 1948, and a "10/2 Panel," the first predecessor of today's Operations Advisory Group, was established. The panel was to review, but not approve, covert action proposals. The 1948 directive was superseded by NSC 10/5 on October 23, 1951. This directive authorized an expansion of world-wide covert operations¹² and altered policy coordination procedures.¹³

Throughout this period, NSC directives provided for consultation with representatives of State and Defense, but these representatives had no approval function. There was no formal procedure or committee to consider and approve projects. Nor was a representative of the President consulted. From 1949 to 1952, the DCI approved CIA covert action projects on his own authority;¹⁴ from 1953 to March 1955 the DCI coordinated project approvals with the Psychological

¹¹ Covert operations were carried out by the Office of Strategic Services (OSS) during the Second World War. OSS was disbanded on October 1, 1945. Three months later, on January 22, 1946, President Truman issued an Executive Order creating the Central Intelligence Group (CIG). CIG was the direct predecessor of the CIA. It operated under an executive council, the National Intelligence Agency (NIA). Although a psychological warfare capability existed within CIG, it did not engage in any covert operations during its existence. CIG and NIA were dissolved with the passage of the 1947 National Security Act.

¹² Prior to this time CIA covert operations were largely confined to psychological warfare, and almost all were media-related. These activities included the use of false publications, "black" radio, and subsidies to publications. With the issuance of NSC 10/2, three other categories of covert activity were added to the psychological warfare mission: political warfare, economic warfare and preventive direct action (e.g., support for guerrillas, sabotage and front organizations).

¹³ At this same time, the Office of Policy Coordination (OPC) was merged with the CIA's Office of Special Operations which was responsible for espionage. The CIA's Candestine Service was now in place.

¹⁴ The DCI did, however, undertake external coordination of covert action programs. Under NSC 10/2, the executive coordination group—the 10/2 Panel—met regularly with the CIA's Assistant Director for Policy Coordination to plan and review covert action programs. This procedure continued under the 10/5 Panel.

Strategy Board or the Operations Coordination Board.¹⁵ Certain covert activities were brought to the President's attention at the DCI's initiative.

By the mid-1950s covert action operations were no longer an ad hoc response to specific threats. They had become an institutional part of the "protracted conflict" with the Soviet Union and Communism. In September 1954, a Top Secret report on CIA covert activities, prepared in connection with the second Hoover Commission, was submitted to President Eisenhower. The introduction to that report is enlightening for what it said about how covert operations were viewed at that time, as well as the rationale for them.

As long as it remains national policy, another important requirement is an aggressive covert psychological, political and paramilitary organization more effective, more unique, and if necessary, more ruthless than that employed by the enemy. No one should be permitted to stand in the way of the prompt, efficient, and secure accomplishment of this mission.

It is now clear that we are facing an implacable enemy whose avowed objective is world domination by whatever means and at whatever cost. There are no rules in such a game. Hitherto acceptable norms of human conduct do not apply. If the U.S. is to survive, longstanding American concepts of "fair play" must be reconsidered. We must develop effective espionage and counterespionage services and must learn to subvert, sabotage, and destroy our enemies by more clever, more sophisticated, and more effective methods than those used against us. It may become necessary that the American people be made acquainted with, understand and support this fundamentally repugnant philosophy.

Two significant NSC directives on covert activities were issued in 1955. The first, NSC 5412/1, made the Planning and Coordination Group (PCG), an OCB committee, the normal channel for policy approval of covert operations.¹⁶ Approval by an executive committee was now the rule. The second NSC directive was issued later in 1955 and remained in force until NSDM 40, which created the 40 Committee, was issued in February, 1970. Because of the significance of this second directive—it covered policy objectives as well as approval and control procedures—and the fact that it stood as U.S. policy for fifteen years, it deserves detailed consideration.

The directive reiterated previous NSC statements that the overt

¹⁵ The Psychological Strategy Board (PSB), an NSC subcommittee established April 4, 1951, was charged with determining the "desirability and feasibility" of proposed covert programs and major covert projects. A new and expanded "10/5 Panel" was established, comprising the members from the earlier 10/2 Panel, but adding staff representation of the PSB. The 10/5 Panel functioned much as the 10/2 Panel had, but the resulting procedures proved cumbersome and potentially insecure. Accordingly, when the PSB was replaced by the Operations Coordinating Board (OCB) on September 2, 1953, coordination of covert operations reverted to a smaller group identical to the former 10/2 Panel, without OCB staff participation. In March 1954, NSC 5412 was issued. It required the DCI to consult with the OCB.

¹⁶ NSC 5412/1 was issued March 12, 1955. That same month the DCI briefed the PCG on all CIA covert operations previously approved under NSC-4-A, 10/2, 10/5, and 5412.

foreign activities of the U.S. Government should be supplemented by covert operations." It stated, in part, that the CIA was authorized to:

—Create and exploit problems for International Communism.

—Discredit International Communism, and reduce the strength of its parties and organization.

—Reduce International Communist control over any areas of the world.

—Strengthen the orientation toward the United States of the nations of the free world, accentuate, wherever possible, the identity of interest between such nations and the United States as well as favoring, where appropriate, those groups genuinely advocating or believing in the advancement of such mutual interests, and increase the capacity and will of such peoples and nations to resist International Communism.

—In accordance with established policies, and to the extent practicable in areas dominated or threatened by International Communism, develop underground resistance and facilitate covert and guerrilla operations. . . .

The directive dealt with means as well as ends:

—Specifically, such [covert action] operations shall include any covert activities related to: propaganda, political action, economic warfare, preventive direct action, including sabotage, anti-sabotage, demolition, escape and evasion and evacuation measures; subversion against hostile states or groups including assistance to underground resistance movements, guerrillas and refugee liberation groups; support of indigenous and anti-communist elements in threatened countries of the free world; deception plans and operations and all compatible activities necessary to accomplish the foregoing.

Control and approval procedures were significantly altered by this directive. The OCB's functions were transferred to "designated representatives" of the Secretaries of State and Defense and the President. This was the first time a "designated representative" of the President had been brought into the approval, or consultative, process. The Special Group, as this committee came to be known, was charged with reviewing and approving covert action programs initiated by the CIA.¹⁷

Even under the new directive, criteria governing the submission of covert action projects to the Special Group were never clearly defined.

As a 1967 CIA memorandum stated:

The procedures to be followed in determining which CIA [covert action] operations required approval by the Special

¹⁷Coordination procedures were slightly modified on March 26, 1967. The Secretary of State was given sole approval authority for particularly sensitive projects that did not have military implications. Further, the CIA was now required to keep the Departments of State and Defense advised on the progress in implementing all approved covert action programs.

Group or by the Department of State and other arms of the U.S. Government were, during the period 1955 to March 1963, somewhat cloudy, and thus can probably best be described as having been based on value judgments by the DCI.

In the beginning, meetings of the Special Group were infrequent. This may be explained, in part, by the special relationship that existed among CIA Director Allen Dulles, his brother John Foster Dulles who was Secretary of State, and President Eisenhower. Early in 1959, regular weekly meetings of the Special Group were instituted, with one result that criteria for submission of projects to the Group were, in practice, considerably broadened. It was not until March 1963, however, that criteria for submission to the Special Group became more formal and precise. These submission criteria are the same as exist today. (See page 53.)

One other development during this period deserves mention. After a shoot-down of an American RB 47 aircraft in the Baltic region in June 1959, the Special Group adopted a new attitude toward reconnaissance in sensitive cases. They decided that review required for these missions had previously been inadequate, and established review on a routine basis. The Joint Chiefs of Staff set up a Joint Reconnaissance Center (JRC) to present monthly peripheral reconnaissance programs to the Special Group. The new procedures did not prevent the U-2 incident in 1960.

With the inauguration of President Kennedy in January 1961, Special Group meetings were transferred to the White House under the chairmanship of the President's Special Assistant for National Security Affairs, McGeorge Bundy. For a brief period, General Maxwell Taylor, President Kennedy's military adviser, chaired the group, but this role was again assumed by Bundy when Taylor became Chairman of the JCS. Prior to 1961, the State Department member of the Special Group had been the "informal" chairman.

As a result of the failure of the Bay of Pigs, control procedures for covert operations were tightened. The Special Group continued its once-a-week meeting format and President Kennedy was informed more frequently of covert action proposals. At the same time, however, the control mechanism for approving and monitoring covert operations was fragmented. In addition to the Special Group, two new executive bodies were created—the Special Group on Counter Insurgency (CI) and the Special Group (Augmented).

On January 18, 1963, NSAM 124 was issued. This directive established the Special Group (CI) to help insure effective interagency programs designed to prevent and resist insurgency in specified critical areas, such as Laos. Paramilitary operations were a central focus of this new group. NSAM 124 did not, however, supersede previous NSC directives on covert operations. Nevertheless, a certain number of operations that might have earlier been referred to the Special Group went to the Special Group (CI). General Maxwell Taylor chaired this group and McGeorge Bundy and Robert Kennedy served on it, among others.

In 1962 a third NSC subcommittee was established, the Special Group (Augmented). Its purpose was to oversee Operation MON-GOOSE, a major new CIA covert action program designed to overthrow Fidel Castro. Its membership included, in addition to the regular Special Group members, Attorney General Kennedy and General

Taylor, Secretary of State Rusk and Secretary of Defense McNamara occasionally attended meetings.¹⁸

During the Johnson Administration, the Special Group, which was renamed the 303 Committee,¹⁹ continued to be chaired by the President's Assistant for National Security Affairs, first McGeorge Bundy, and, after 1966, Walt Rostow. The most important regular, high-level meeting in the national security process during the Johnson years was, however, the Tuesday Lunch group. The Tuesday Lunch began as an informal meeting of President Johnson, Secretary of State Rusk, Secretary of Defense McNamara, and Bundy. Gradually, the meetings became a regular occasion and participation was enlarged to include the President's press secretary, the Director of Central Intelligence, and the Chairman of the JCS. The agenda of the Tuesday Lunch was devoted primarily to operational decisions—mostly on Vietnam. Although the Tuesday Lunch was not meant to substitute for the 303 Committee, it probably did consider important matters involving covert operations directed at North Vietnam.

2. The 40 Committee and current procedures

On February 17, 1970, NSDM 40 was issued. It created the 40 Committee. The directive superseded and rescinded past NSC covert action directives. It discussed both policy and procedure. With regard to policy, NSDM 40 stated that it was essential to the defense and security of the United States and its efforts for world peace that the overt foreign activities of the United States Government continue to be supplemented by covert action operations.

NSDM 40 assigned the DCI responsibility for coordinating and controlling covert operations. The Director was instructed to plan and conduct covert operations in a manner consistent with United States foreign and military policies and to consult with and obtain appropriate coordination from any other interested agencies or officers on a need-to-know basis.

The directive also spelled out the role of the 40 Committee. It stated that the DCI was responsible for obtaining policy approval for all major and/or politically sensitive covert action programs through the 40 Committee. In addition, NSDM 40 continued the Committee's responsibility for reviewing and approving overhead reconnaissance missions, a responsibility first acquired in 1959.

A new provision, not found in previous NSC directives, required the Committee to annually review covert operations previously approved, and made the DCI responsible for insuring that the review took place.

Guidelines for the submission of covert action proposals to the 40 Committee were spelled out in an internal CIA directive.²⁰ The Director of Central Intelligence decided whether an operational program

¹⁸ For a detailed account of the workings of the Special Group (Augmented), see the Committee's Interim Report on "Alleged Assassination Plots Involving Foreign Leaders," pp. 139-148.

¹⁹ In June 1964 NSAM 303 was issued. NSAM 303 left the composition, functions, and responsibilities of the Special Group unchanged. The effect of this directive was, quite simply, to change the name of the Special Group to the 303 Committee. The purpose of NSAM 303 was just as simple—the name of the Special Group had become public as a result of the publication of the book *The Invisible Government* and, therefore, it was felt that the name of the covert action approval committee should be changed.

²⁰ This directive will, at least initially, continue in effect for the new Operations Advisory Group.

or activity should be submitted to the 40 Committee for policy approval. The paramount consideration was political sensitivity, but it was also significant if a program involved large sums of money. In the past, a "large" project was one costing over \$25,000, but this guideline seems less clear today. As a general rule, the following types of programs or activities required 40 Committee action: political and propaganda action programs involving direct or indirect action to influence or support political parties, groups or specific political or military leaders (this included governmental and opposition elements); economic action programs; paramilitary programs; and counterinsurgency programs where CIA involvement is other than the support and improvement of the intelligence collection capabilities of the local services.

The internal CIA directive also stated that before proposals were presented to the DCI for submission to the 40 Committee, they *should* be coordinated with the Department of State. Further, paramilitary action programs *should* be coordinated with the Department of Defense, and, *ordinarily*, concurrence by the Ambassador to the country concerned would be required. [Emphasis added.]

"Should" and "ordinarily" were underscored for an important reason: major covert action proposals are not always coordinated among the various departments. Nor, for that matter, were they always discussed or approved by the 40 Committee. For example, the CIA's 1970 effort to promote a military coup d'état in Chile, undertaken at the instruction of President Nixon, was never brought before the 40 Committee.

After a proposal was approved by the DCI, it was distributed in memorandum form to the 40 Committee principals.²¹ Except in emergencies, distribution to the principals was to occur at least 72 hours in advance of a meeting. Normally, the written proposal, as contained in the 40 Committee memorandum, was formally considered following an oral presentation by the CIA. This presentation was usually given by the Agency Division Chief having action responsibility. In addition to the principals, participants at 40 Committee meetings included, on occasion, the CIA's Deputy Director for Operations, a representative from the State Department's Bureau of Intelligence and Research, and the Assistant Secretary of State for the region involved.

The 40 Committee could approve, modify, or reject any covert action proposal. Proposals involving continuing action—for example, a subsidy to a political group—were normally approved for a fixed period, one year or less, at the end of which the project was again reviewed by the Committee and either continued or eliminated. Reconnaissance programs were rarely dealt with at these meetings. They were usually cleared by telephone vote rather than at a formal meeting.

Prior to 1969 it does not appear that all 40 Committee approvals were routinely referred to the President. The President would become involved, formally, only if there was disagreement within the Committee, or if the Chairman or another member thought a proposal was

²¹ The memorandum described the proposal in summary form: what it was expected to accomplish, its cost and the availability of funds, whether there were alternative means for achieving the objectives sought, the risks involved, and the possible consequences of disclosure.

sufficiently important, or sensitive, to warrant the President's attention. However, as a result of the Hughes-Ryan Amendment to the 1974 Foreign Assistance Act, the President is notified once a covert action proposal has been approved by his executive committee. The President is then required to certify to Congress that the approved covert action proposal is "important to the national security interests of the United States." The DCI then informs the Congress of this "Presidential Finding" in a "timely manner." In practice, informing Congress means notifying six different committees—the Senate and House Committees on Armed Services, Foreign Relations and Appropriations.²² The DCI does not, however, feel obligated to inform the six committees of approved covert action operations prior to their implementation, although in some cases he has done so. Once the "Presidential Finding" is in hand, the CIA's Directorate of Operations implements the proposal.

During the early years of the Nixon Administration, 40 Committee meetings were held regularly although, on occasion, proposals were approved by telephone vote. Over time, however, formal meetings became fewer and fewer. This was due, in part, to a decline in covert action projects. Most business was done by telephone after proposals had been circulated in advance by couriers. Business became routine. "Telephone concurrences," involving quick checks rather than intensive discussion, was the rule. However, for major new departures, the Committee met in person. For example, the 40 Committee met nine times between January 22 and December 11, 1975, to discuss Angola. The National Security Council met once, on June 27, 1975. In addition, an Interagency Working Group on Angola met 24 times between August 13, 1975, and January 14, 1976. The number and frequency of meetings on Angola appears to reflect a need on the part of policymakers to sit down and discuss the desirability and mechanics of undertaking a major new covert operation. When a new departure is not being considered, when policy and interests are not shifting, 40 Committee business remained routine, usually conducted by telephone.

Two additional points concerning 40 Committee procedures are important. First, covert action proposals were resubmitted by the DCI to the 40 Committee when there was a need to reassess or reaffirm previous policy decisions. Resubmission would occur if new developments warranted it, or if specifically required by the 40 Committee at the time of approval.

Second, status reports on covert action programs and activities were submitted when requested by the 40 Committee or at the discretion of the DCI. Status reports were presented at least annually to the 40 Committee for each continuing activity approved by the Committee. Apparently, however, these annual reviews were little more than pro forma exercises carried out by the DCI. They were not thorough examinations of on-going projects by the 40 Committee principals.²³

²² In addition, both the Senate and House Select Committees on Intelligence Activities were briefed on current covert operations.

²³ According to the CIA, prior to the review of these annual reports by the 40 Committee principals they were submitted in draft to the concerned agencies for comment. Thus, the staff of 40 Committee principals had an opportunity to examine on-going projects.

3. Covert Action Approvals

It is difficult to determine the number of covert operations approved over the years by the 40 Committee or its predecessors. Records for the early years are either not available or are incomplete. Also, there has been a steady refinement of "programs" into individual "projects," thus making comparisons difficult. Despite this, a rough determination can be made of projects approved for the period 1949 to 1967.²⁴

Between 1949 and 1952, 81 projects were approved by the DCI on his own authority after coordination with either the 10/2 or 10/5 Panels. During the first two years of the Eisenhower administration, 1953-54, 66 projects were approved by the DCI in coordination with the Operations Coordination Board or the Psychological Strategy Board. Between March 1955 and February 1967, projects approved or reconfirmed by the Operations Coordination Board, the Special Group, or the 303 Committee were as follows:

Eisenhower administration—104

Kennedy administration—163

Johnson administration—142

These totals reflect two things: first, an increase in the number of projects approved and, second, a tightening up of approval procedures. Regarding procedures, a CIA memorandum, dated February 25, 1967, stated:

As the sophistication of the policy approval process developed so did the participation of the external approving authority. Since establishment of the Special Group (later 303 Committee), the policy arbiters have questioned CIA presentations, amended them and, on occasion, denied them outright. The record shows that the Group/Committee, in some instances, has overridden objections from the DCI and instructed the Agency to carry out certain activities. . . . Objections by State have resulted in amendment or rejection of election proposals, suggestions for air proprietaries and support plans for foreign governments. . . . The Committee has suggested areas where covert action is needed, has decided that another element of government should undertake a proposed action, imposed caveats and turned down specific proposals for CIA action from Ambassadors in the field.

Whereas the "sophistication of the policy approval process" and the "participation of the external approving authority" has increased significantly since the establishment of the Special Group in 1955, this has not meant that all, or even a majority, of covert action projects have been approved by the "external approving authority." Low-risk, low-cost covert action projects, such as a routine press placement or the development of an "agent of influence," do not receive this attention. In this regard, an Agency memorandum, dated February 21, 1967, stated:

It is obvious that a compilation of Special Group approvals in no way reflects the totality of significant CIA activities carried on over the past 15 years. With respect to overall

²⁴ These numbers may include reapprovals of projects initiated earlier.

DDP activity, it does not include any mention of FI/CI [Foreign Intelligence/Counterintelligence] actions or, of course, any decisions in the overt field. Even within the restricted framework of covert action alone, a 1963 study prepared by this office showed that of the 550 existing CIA projects of the DDP which were reviewed against the background of our own internal instruction on Special Group submission, only 86 were separately approved (or reapproved) by the Special Group between 1 January and 1 December 1962.

Using the figures cited above, this would mean that 16 percent of all covert action projects, large and small, received Special Group approval between January 1 and December 1, 1962. The Select Committee's own review indicates that of the several thousand covert action projects undertaken since 1961, only 14 percent were considered on a case-by-case basis by the 40 Committee or its predecessors.²⁵ Those not reviewed by the committee were the low-risk, low-cost type referred to above.

Another indication of the number of covert action proposals which eventually reached the 40 Committee is contained in the CIA's 1972 *Covert Action Manual*. According to this document, "the 40 Committee actually looks at about one-fourth of our covert action projects." The Manual continues:

. . . this proportion is a reflection on the nature of the project system, not on any lack of policy approval for our covert actions. For example, the Agency would have separate projects for each of a number of media assets that might be brought to bear on an overall program of persuasion, but the 40 Committee would focus on the program with its descriptions of the specific assets to be employed. . . . *Thus, the important point on policy is that the 40 Committee considers individually all major and critical projects providing broader program guidelines for the remainder of our covert activity.* [Emphasis added.]

4. *The NSC and Covert Activities: Conclusions*

Several points stand out in the history of the committees charged with overseeing covert operations. The most obvious has less to do with procedures than with the substance of the projects approved. The justification for covert operations has changed sharply, from containing International (and presumably monolithic) Communism in the early 1950s to merely serving as an adjunct to American foreign policy in the 1970s. It should be noted that early NSC directives framed the purpose of covert operations entirely in terms of opposition to International Communism. By contrast, NSDM 40 described covert actions as those secret activities designed to further official United States programs and policies abroad.

²⁵ According to the CIA, since the Hughes-Ryan Amendment to the 1974 Foreign Assistance Act, all covert action projects not submitted on a case-by-case basis have been submitted to the President for approval and to the oversight committees of Congress for its information in collective, omnibus form.

As stated, procedural arrangements for considering and approving covert operations have been formalized and tightened over the years. NSC-4-A of 1947 established no formal procedures for coordinating or approving operations; the DCI, in liaison with State and Defense, was to ensure that operations were consistent with United States policy. Over time, procedures were developed and guidelines established to indicate which covert action proposals required 40 Committee approval. The requirement of a "Presidential Finding" in the 1974 Foreign Assistance Act not only requires the President to certify to Congress that an approved covert operation is important to the national security of the United States, but, in effect, compels him to become aware of actions approved by the 40 Committee.²⁶ The concept of plausible denial, at least as it applies to the President, is dead. Major new covert operations cannot be undertaken without the knowledge, and approval, of the Chief Executive. President Ford's Executive Order takes this one step further. The new Operations Advisory Group will not be responsible for policy approval of covert operations, as was the 40 Committee. According to the Executive Order, the Group will "consider and develop any policy recommendation, including any dissents, for the President prior to his decision" on each covert operation. The approval of covert operations now rests solely with the President.

However, recognition that procedural arrangements for considering and approving covert operations have become tighter does not necessarily imply that they are adequate. Significant issues regarding the control of covert operations remain. First, the criteria for determining which covert operations are brought before the Executive are still inadequate. Small covert action projects not deemed politically risky can be approved within the CIA. Although many of these are in support of projects already approved by the Executive, they nevertheless make up a majority of all CIA covert action projects. In addition, some of the low-risk projects approved within the CIA, such as the development of a foreign "asset," may prove to be extremely sensitive and risky. One CIA "asset," given the cryptonym QJ/WIN, was recruited to spot "individuals with criminal and underworld connections in Europe for possible multi-purpose use."²⁷ Later the CIA contemplated using QJ/WIN for its ZR/RIFLE project, a "general stand-by capability" to carry out assassination when required. Other CIA individual project "assets" used in connection with plots to assassinate foreign leaders were WI/ROGUE and AM/LASH.

* President Ford has recommended that the "Presidential Finding" requirement be dropped. In his message to Congress outlining his intelligence reorganization, the President recommended that the 1974 Foreign Assistance Act (Public Law 93-559) be modified as proposed by the Commission on the Organization of the Government for the Conduct of Foreign Policy. That Commission, chaired by Robert Murphy, recommended:

"We propose that Public Law 93-559 be amended to require reporting of covert actions to the proposed Joint Committee on National Security, and to omit any requirement for the personal certification of the President as to their necessity." (Commission on the Organization of the Government for the Conduct of Foreign Policy, 6/76, p. 101.)

²⁷ Senate Select Committee, "Alleged Assassination Plots Involving Foreign Leaders," p. 182. See this report for a full discussion of QJ/WIN, ZR/RIFLE, WI/ROGUE and AM/LASH.

Though none of these specific projects were apparently approved by the NSC, several ranking CIA officials testified that they were within the general policy approved at the NSC level.

Second, there were gaps in 40 Committee supervision, notably in the sensitive areas of human espionage and counterintelligence. Whether intended or not, espionage and counterintelligence operations may have the effect of political action. A former chairman of the Special Group, McGeorge Bundy, has testified that the distinction among these operations needs re-examination. According to Bundy:

Intelligence collection is often separated from covert operations in the thinking of intelligence administrators and other concerned officials. I think this distinction, like the parallel distinction in the field of counterintelligence, deserves re-examination. Both intelligence collection and counterintelligence have involved covert activity which goes well beyond conventional espionage and counterespionage, and such enlargements of activity often present many of the same dangers as covert actions of other sorts.²⁸

Espionage operations can have the effect of political action. A payment to a dissident leader may be designed to collect intelligence on the leader's group, but it may also be regarded as support for the group's objectives. Counterintelligence operations can have a similar impact. Counterintelligence measures used to enlist the support of local intelligence and police, neutralize hostile intelligence services, and discredit local CIA opponents are sometimes indistinguishable from covert action. As such, the issue is whether these intelligence activities can, or should, be made subject to effective executive branch and congressional oversight. President Ford's Executive Order does not address this issue. The Operations Advisory Group will be responsible for approving certain "sensitive intelligence collection operations," but the Executive Order does not apparently include human as well as technical collection. Nor is there any reference to Operations Group review or approval of any counterintelligence activities.

Third, there is a basic conflict between sufficient consultation to ensure accountability and sound decisions on the one hand, and secure operations on the other. 40 Committee approval procedures for covert operations were, on occasion, by-passed by the President or his National Security Affairs adviser. For highly sensitive proposals the number of individuals or agencies consulted or informed is sometimes sharply limited on a "need to know" basis. Even the ambassador in the country where the operation is to be conducted may not be informed. Middle and lower level officials within the State Department or the CIA with expertise may not be consulted. The risk of inadequate consultation was aggravated by the informality of telephone clearances. President Ford's Executive Order attempts to remedy this deficiency, at least in part. The Executive Order states:

The Operations Group shall discharge the responsibilities assigned . . . only after consultation in a formal meeting at-

²⁸ McGeorge Bundy testimony, House Select Committee on Intelligence, 12/10/75.

tended by all members and observers; or . . . when a designated representative of the member or observer attends.^{28a}

Finally, the annual review of covert actions by the 40 Committee did not appear to be searching or thorough. Annual reviews were often handled in the same informal manner as approvals for new covert action proposals—by telephone concurrence. Some ongoing covert operations have been challenged over the years, most often by the State Department. Some die a natural death. Some linger on for as long as 20 to 25 years. It appears that some covert operations, such as those in Italy, may come to an end only when they are exposed. President Ford's Executive Order contains two provisions to increase the number of covert action reviews. First, the Operations Advisory Group will be required to "conduct periodic reviews of programs previously considered." There is no requirement, however, that these reviews must take place at a formal meeting. Second, the Executive Order requires the full National Security Council to review, twice a year, the "continued appropriateness" of ongoing covert operations.

5. Role of OMB

In order to meet unanticipated needs, the CIA maintains a Contingency Reserve Fund. The fund is replenished by annual appropriations as well as unobligated funds from previous CIA appropriations. More often than not, the unanticipated needs of the CIA relate to covert operations.

The Director of Central Intelligence has the authority, under the Central Intelligence Agency Act of 1949, to spend reserve funds without consulting OMB. However, due to an arrangement among OMB, the CIA, and the Appropriations Committees of Congress, the CIA has agreed not to use reserve funds without OMB approval. There is no evidence that the DCI has ever violated this agreement. In practice, OMB holds a double key to this reserve fund: first, it approves additions to the reserve fund and, second, it approves the amounts to be released from the fund, upon CIA request and justification. OMB holds a careful review of each proposed release. Turndowns are rare, but reductions in amounts requested occur often enough to prompt a careful CIA presentation of its case.

Despite these levers of control, OMB has faced several handicaps which render its control of the Contingency Reserve Fund less effective than it might be. First, OMB has not, in the past, been represented on the National Security Council or the 40 Committee.²⁹ Much of the dollar volume of reserve releases originates in 40 Committee action. Thus, OMB resistance to reserve release requests were often in the face of policy determinations already made. Second, although the chairmen of the appropriations subcommittees of Congress are notified of draw-downs from the fund, these notifications occur *after* the release action, even though the release is conceptually the same as a supplemental appropriation. Thus, OMB does not have the leverage in regard to

^{28a} Executive Order 12065, Sec. 3(c)(3).

²⁹ Under President Ford's Executive Order, the Director of OMB will sit as an observer on the Operations Advisory Group, the successor to the 40 Committee.

Contingency Reserve Fund releases that it does in regard to supplemental appropriations requests (where OMB is a party to recommending supplementals to the President and Congress).

OMB suffers other limitations with respect to the use of CIA funds for covert operations. First, CIA's budget submission to OMB has, in the past, neglected some aspects of clandestine spending, notably proprietary activities. Second, current ground rules allow the reprogramming of CIA's regular appropriations to meet unanticipated needs; no OMB approval is required for this reprogramming. To the extent that the above funds are used for covert operations, OMB has no control over their use.

C. PROVIDING THE INTELLIGENCE REQUIRED BY POLICYMAKERS

1. *Work of NSCIC*

The National Security Council Intelligence Committee was formed in November 1971. At its first meeting, a Working Group, composed primarily of officials from the intelligence community, was established. That composition was soon seen as inappropriate for a committee whose main purpose was to make intelligence more responsive to the needs of policymaking "consumers." As a result, at its second—and last—meeting, NSCIC changed the composition of the Working Group to exactly parallel the parent body.³⁰

The various representatives who sat on the Working Group were not the "intelligence" specialists from those agencies, but officials with policymaking responsibilities. For example, the State Department was represented by the Director of the Bureau of Politico-Military Affairs, not the Director of the Bureau of Intelligence and Research. Representatives were to seek the views of the operating bureaus of their agencies on major intelligence questions.

An August 1974 meeting of NSCIC produced two direct results. In response to a request for some mechanism to highlight critical intelligence memoranda, the DCI now puts out "alert memoranda"—brief notices in a form which cannot be overlooked. The meeting also resulted in the production of a National Intelligence Estimate (NIE) on Soviet perceptions of the United States.

Before it was abolished, NSCIC began reviewing the basic documents which levy requirements on the intelligence community—the DCI's Perspectives on Intelligence, Substantive Objectives, and especially, Key Intelligence Questions (KIQs). NSCIC also set up a Working Group panel to conduct surveys of intelligence community publications. There was also an NSCIC subcommittee which considered economic intelligence, chaired by the Assistant Secretary of the Treasury for International Affairs. The subcommittee was inactive.

³⁰ The Assistant to the President for National Security Affairs (Chairman), the DCI (Vice Chairman), the Deputy Secretaries of State and Defense, the Chairmen, JCS, and the Under Secretary of Treasury for Monetary Affairs.

2. *Limitations on Effectiveness*

NSCIC's work reflected the basic dilemma inherent in suiting intelligence to the needs of policymakers. The intelligence community must be close enough to policymakers to know what is desired, yet distant enough to preserve its objectivity. Within this framework, the differing demands of many kinds of policymakers must be balanced. For example, making the intelligence community more responsive to the needs of Cabinet-level officials might diminish the quality of the intelligence produced for middle-level officials.

The limited effectiveness of NSCIC was due to several factors:

—The apparent lack of interest of senior officials in making NSCIC work.

—The demands of other business on the sub-cabinet level officials who made up NSCIC.

—“Consumer” unfamiliarity with the intelligence community. Of necessity, NSCIC spent most of its time educating policymakers about the community and what it can do. Most officials in policymaking positions, especially those in senior positions, bring little intelligence experience to their jobs. One of NSCIC's first tasks was to produce a manual about the community for policymakers.

—Diversity among “consumers.” Cooperative arrangements and the tradition of working together are matters of long standing within the intelligence community. By contrast, NSCIC represented a first attempt to bring “consumers” together. The newness of the endeavor combined with the diversity of the “consumers” made it difficult for NSCIC to function effectively.

3. *Conclusions*

The intelligence community has not always been responsive to the needs of policymakers. Some have argued that the intelligence product is more a reflection of what “producers,” rather than “consumers,” deem important. This is debatable. What is not at issue, however, is that “consumers” should drive the intelligence process. NSCIC was a disappointment in this regard. To say this is not to imply that the intelligence community has been unresponsive to the needs of policymakers. Just the opposite may be true. “Producers” and “consumers” came together almost daily at NSC subcommittee meetings (e.g., the Senior Review Group and the Washington Special Action Group.) Intelligence requirements are levied, informally, at these meetings. It can be assumed that the intelligence community has been responsive to these informal requirements and hence the need for a more formal NSC mechanism—NSCIC—was eliminated. The new Committee on Foreign Intelligence will now have the responsibility for seeing that policymakers are provided the intelligence they need.

D. ADVERTISING THE PRESIDENT ON INTELLIGENCE ISSUES

1. *Overview*

The President needs an independent body to assess the quality and effectiveness of our foreign intelligence effort. Since 1956 the President's Foreign Intelligence Advisory Board (PFIAB) has served this function. Numerous proposals have recently been made to make

PFIAB an executive "watchdog" over United States foreign intelligence activities. Some have suggested that a joint presidential/congressional intelligence board be established or, at the least, Senate confirmation of members of the President's board be required. The Rockefeller Commission recommended that the Board's functions be expanded to include oversight of the CIA with responsibility for assessing CIA compliance with its statutory authority. The Murphy Commission commented favorably on the Rockefeller Commission recommendations. Whether PFIAB should adopt this oversight or "watchdog" function, or whether Congress should be involved in the activities of the Board is open to question. President Ford, in his Executive Order, decided against transforming the Board into a CIA watchdog. Instead, he created a new three-member Intelligence Oversight Board to monitor the activities of the intelligence community.

2. *History of PFIAB*

On February 6, 1956, President Eisenhower created, by Executive Order, the Board of Consultants on Foreign Intelligence Activities. The Board was established in response to a recommendation by the second Hoover Commission, calling for the President to appoint a committee of private citizens who would report to him on United States foreign intelligence activities. Creation of the Board was also intended to preempt a move in Congress at the time, led by Senator Mike Mansfield, to establish a Joint Congressional Committee on Intelligence.

The Board ceased functioning when President Eisenhower left office in 1961, but was reactivated by President Kennedy following the Bay of Pigs failure. It was renamed the President's Foreign Intelligence Advisory Board (PFIAB) and has functioned, uninterrupted, since that time.

3. *PFIAB Today*

The Board currently operates under Executive Order 11460, issued by President Nixon on March 20, 1969. The Board is responsible for reviewing and assessing United States foreign intelligence activities. It reports to the President periodically on its findings and recommendations for improving the effectiveness of the nation's foreign intelligence effort.

The Board presently has seventeen members, all drawn from private life and all appointed by the President. It is chaired by Leo Cherne, and holds formal meetings two days every other month. It has a staff of two, headed by an executive secretary.

As its name indicates, the Board is advisory. Board reports and recommendations have contributed to the increased effectiveness and efficiency of our foreign intelligence effort. For example, the Board played a significant role in the development of our overhead reconnaissance program. It has made recommendations on coordinating American intelligence activities; reorganizing Defense intelligence; applying science and technology to the National Security Agency, and rewriting the National Security Council Intelligence Directives (NSCIDs). The Board has conducted post-mortems on alleged intelligence failures and, since 1969, made a yearly, independent assessment of the Soviet strategic threat, thereby supplementing regular community intelligence

assessments. Most recently, it has reported to the President on economic intelligence and human clandestine intelligence collection.

The Board has not served a "watchdog" function. As the Rockefeller Commission noted, the Board does not exercise control over the CIA, which is, in fact, the Board's only source of information about Agency activities. When the Board has occasionally inquired into areas of possible illegal or improper CIA activity, it has met resistance. For example, when the Board became aware of the so-called Huston Plan and asked the FBI and the Attorney General for a copy, the request was refused. The Board did not pursue the matter with the White House. In 1970, the Board was asked by Henry Kissinger, then the President's National Security Advisor, to examine Allende's election victory in Chile to determine whether the CIA had failed to foresee, and propose appropriate actions, to prevent Allende's taking office. The Board requested 40 Committee and NSC minutes to determine the facts. Its request was refused and its inquiry was dropped.

The President needs an independent body to assess the quality and effectiveness of our foreign intelligence effort. In the words of its Executive Secretary, the Board has "looked at intelligence through the eyes of the President." PFIAB has served, in effect, as an intelligence "Kitchen Cabinet." The Board has been useful, in part, because its advice and recommendations have been for the President. As such, the executive nature of this relationship should be maintained.

Over the years, many of PFIAB's recommendations have been adopted, and others have served as a basis for later reform or reorganization. The Board has not been an executive "watchdog" of the CIA. To make it so would be to place the Board in an untenable position: adviser to the President on the quality and effectiveness of intelligence on the one hand and "policeman" of the intelligence community on the other. These two roles conflict and should be performed separately.

4. *Intelligence Oversight Board*

To assist the President, the NSC, and the Attorney General in overseeing the intelligence community, President Ford has created an Intelligence Oversight Board. The Board will consist of three private citizens appointed by the President. They will also serve on PFIAB.

The Board will be, in effect, a community-wide Inspector General of last resort. It will review reports from the Inspectors General and General Counsels of the intelligence community and report periodically to the Attorney General and the President on any activities which appear to be illegal or improper. The Board will also review the practices, procedures, and internal guidelines of the various IGs and General Counsels to ensure that they are designed to bring questionable activities to light. Finally, the Board will see to it that intelligence community IGs and General Counsels have access to any information they require.

The President's Intelligence Oversight Board should serve a useful purpose. However, the ability of a small, part-time Board to monitor the activities of the entire intelligence community is questionable. Further, the Board is a creature of the Executive and, as such, may be unable or, at times, unwilling to probe certain sensitive areas. A

body independent of the Executive must also be responsible for monitoring the activities of the intelligence community, including those which may be either illegal or improper.

E. ALLOCATING INTELLIGENCE RESOURCES

1. Role of OMB

The Office of Management and Budget (OMB) is the principal staff arm of the President for supervising the Federal budget. OMB is also a staff arm for management—a tool the President occasionally uses to reorganize or redirect the structure and activities of the Federal Government.

In managing U.S. intelligence activities, the President has used OMB to pull together his annual intelligence budget and also to monitor the expenditure of intelligence funds. For example, OMB annually reviews the intelligence community's appropriations requests and makes its recommendations to the President for amounts to be included in his budget. Further, OMB apportions³¹ CIA's appropriation and has authority to approve releases from the CIA Contingency Reserve Fund.

The fiscal management responsibility of OMB has been especially critical in the field of intelligence. Intelligence activities comprise a large part of that small and shrinking portion of the federal budget which is "controllable."³² About 75 percent of federal spending for fiscal 1976 was designated in the President's budget submission as "uncontrollable." The Committee has found that the direct cost of national intelligence spending is currently [deleted] and total intelligence spending is approximately twice that. Thus the total U.S. intelligence budget is about [deleted] percent of federal spending, but is [deleted] percent of *controllable* federal spending. Because the U.S. intelligence budget is fragmented and concealed, the relationship between controllable intelligence program and controllable federal spending has never been shown to Congress in the President's budget. OMB has been a principal point at which the President can identify and exert management leverage over this aggregate of controllable funds.

Over the years, OMB (and its predecessor, the Bureau of the Budget) has had the greatest management impact when:

- It has been used as an instrument of presidential reorganization;

- It has identified major issues for the President, usually involving bids by intelligence agencies to maintain or launch duplicative or marginally useful programs.

For example, in 1960 President Eisenhower commissioned the Budget Bureau to establish a Joint Study Group of the principal intel-

³¹ "Apportionment" of funds is described by budgetary statutes as the OMB action, following congressional appropriations, whereby agencies receive formal notification of amounts appropriated and the distribution of spending by time period and program.

³² Defined as spending that is not predetermined by statute, such as interest on the federal debt, veterans benefits, Social payments, et cetera.

ligence agencies to take a hard look at U.S. intelligence collection requirements and other problems. In its report, the Joint Study Group recommended to the President a variety of measures to strengthen intelligence management, including a more assertive role for the DCI, stronger control by NSA of the cryptologic agencies, and centralized management of collection requirements.

A decade later, President Nixon commissioned OMB to probe the management of the intelligence community, and to determine what changes, short of legislation, might be made. An ensuing report by Assistant OMB Director James Schlesinger concluded that the division of labor envisaged by the National Security Act of 1947 had been rendered obsolescent and meaningless by technology and the ambitions of U.S. intelligence agencies. The Schlesinger Report recommended nothing less than the basic reform of U.S. intelligence management, centering upon a strong DCI who could bring intelligence costs under control and bring intelligence production to an adequate level of quality and responsiveness. In addition, the OMB report pointed to nine specific mergers or shifts of intelligence programs estimated to save nearly one billion dollars annually.

OMB has also been an occasional lightning rod for the identification of specific budget or management issues. In the mid-sixties the Bureau of the Budget called the President's attention to the problems of better coordinating the costs and benefits of overhead reconnaissance. Further, the Bureau pressed hard for a reorganization of Defense mapping and charting activities emphasizing the issues of needless duplication of service mapping agencies. This was resolved following the Schlesinger Report.

2. Recent Trends and Programs

OMB reportedly was given a major role in developing the recommendations presented to President Ford for overhauling intelligence budgeting and management. If this was the case, it would reverse a recent trend. Since 1971, OMB's day-to-day influence upon intelligence management has been at a low point. OMB has been confined to its cyclical, institutional role in the budget process. The strengths and weaknesses of this role will be discussed below.

3. OMB Role in Formulating the Budget

OMB can always get the President's attention in recommending what should be included in his annual budget proposals to Congress. Associated with OMB budget recommendations is the identification of major resource allocation issues, with an analysis of options and a recommended course of action. However, OMB recommendations on intelligence have had less presidential acceptance than in other areas of the federal budget. This has been due to the difficulty of carrying any "military" budget issue opposed by the Secretary of Defense and the relative ineffectiveness of DCI support. Further, OMB is excluded from some of the early, formative stages of DOD program determinations for intelligence which cover eighty percent of the intelligence budget.

For the past three years, with OMB encouragement, the DCI has provided the President with his own recommendations for the national intelligence budget. Unfortunately, these have come too late in the process to have much impact. These recommendations have followed, not preceded, DOD submissions to OMB and OMB's own formative stages of analysis.

The President's annual and five-year planning targets are an integral part of the federal budget process. Federal agencies are adjured to fit their fiscal and staffing plans with the presidential targets, with special emphasis upon the nearest or "budget" year. Presidential targets are especially important in their potential for strengthening central management of the intelligence community. The DCI has recognized this. These targets can assist the DCI in getting more value for the intelligence dollar. However, OMB has issued the planning targets too late in the planning process and without any in-depth coordination of totals and major components with the DCI. By the time the DCI and CIA have received their target figures in June or July, most of the major decisions on budget request levels and year implications have already been agreed to within Defense and CIA. This type of problem is widespread in the federal budget process but, because of the insulation of intelligence from external checks and balances, the problem is especially serious in intelligence budgeting.

The problem is exacerbated by OMB's issuance to the Department of Defense of a planning target which has the effect of constituting an alternative planning base for intelligence. This target has not been directly related to DOD's intelligence budget. The Secretary of Defense has been given, in effect, a choice between a level of intelligence spending consistent with the DCI's planning target and one which matches his own view of overall DOD priorities and claims. Not surprisingly, Secretaries of Defense have tended to opt for the latter. The result, therefore, of the two planning targets has made the DCI's management mandate all the harder to fulfill.

4. Presidential Budget Decisionmaking

OMB's budget recommendations to the President, which culminate OMB's annual budget review, have been the only comprehensive presentations of United States' intelligence spending. These serve to highlight major issues and are done by analysts independent of any intelligence agency. In contrast with the DCI's national intelligence budget presentation, which excludes future year figures and does not have the Secretary of Defense's recommended amounts, the OMB presentation is complete and based upon each agency's final positions. Moreover, the OMB presentation offers specific solutions to the President's problem of restraining intelligence spending without degrading intelligence operations.

These presentations and those related to the DCI's National Foreign Intelligence Budget are not shared with Congress. Therefore, except for selective briefings by the DCI and individual program managers, Congress has not been informed of the major options at stake in the President's budget.

5. Apportionment and Budget Execution

OMB apportionment of appropriated funds is the source of much of OMB's muscle in budget execution. By law (31 U.S.C. 665), federal agencies cannot use appropriated funds in the absence of an OMB apportionment. The apportionment can convey the funds in lump sum, distributed by quarter, or by major program. OMB can impose set-asides and can call special hearings. With regard to intelligence programs, however, OMB apportionment action is weak and fragmented. The only direct intelligence apportionment by OMB is to CIA—i.e., those earmarked amounts of the DOD appropriation which are transferred from Defense to CIA under authority of the Central Intelligence Agency Act of 1949. This apportionment is done in lump sum. The rest of the intelligence budget is scattered among, and apportioned by, some 20 DOD appropriations and an appropriation to State without a distinction made for intelligence funds. Thus, OMB apportionment is procedurally applied to less than 20 percent of the annual national intelligence budget and to less than 10 percent of total intelligence spending.

Another weakness of OMB's ability to monitor budget execution is its procedural blindness to advances, reprogramming, and management of intelligence proprietary activities. Other weaknesses include:

—A large proportion of funds spent for CIA covert action projects have come from Defense Department advances, under authority of the Economy Act, and therefore are outside OMB apportionment.

—OMB does not routinely receive notice of major reprogramming of CIA funds from activities shown and justified in the congressional budget. The premium upon exploitation of unforeseen intelligence opportunities puts a premium upon budgeting flexibility. Yet OMB lacks a set of benchmarks to determine routinely when CIA or other intelligence agencies have substantially departed from the approved budget.

It appears that more than half of all large-scale covert action projects initiated in the period 1961-76 did not come to OMB for review.

6. Absence of GAO Audits

The absence of GAO audits in the intelligence community affects OMB's ability to monitor intelligence performance. In other federal areas GAO audits often include an evaluation of performance effectiveness and economy, as well as compliance. OMB has a standing arrangement to follow up with agencies on GAO audits. GAO audits often provide launching points for OMB investigations or reinforce OMB interests in broader problems. The absence of such independent and critical GAO reports in the intelligence field weakens both OMB and congressional oversight.

7. OMB Representation on Excom**

The process of planning and budgeting for overhead reconnaissance is new enough to have escaped historic overlaps of jurisdiction afflict-

** This EXCOM was abolished as a result of President Ford's recent Executive Order. It is likely that a similar body will be re-established under the direction of the new Committee on Foreign Intelligence.

ing the rest of the intelligence community. An Executive Committee (EXCOM) was established to coordinate reconnaissance development and planning, chaired by the DCI with the Assistant Secretary of Defense for intelligence as the other member. While OMB was not a member of EXCOM, it had a representative at EXCOM meetings. EXCOM decisions often were a compromise between the DCI and the Department of Defense which may or may not have represented the most cost-effective solution. On occasion, the OMB representative took a role in defining options and insisting upon analysis of key points. Here is one area of intelligence budgeting where OMB was actively represented and therefore in a position to help the President identify and resolve large issues.

8. New Assessment of OMB Role in Intelligence Management

OMB's cyclical role in the budget process has the strengths and weaknesses noted. Recognizing that OMB has statutory authority in budget preparation and apportionment of funds, it is nevertheless true that the key to OMB influence for management improvement is the extent to which the President chooses to use and back OMB for specific projects. OMB's role *ought* to be at its strongest in the intelligence community, given the absence of public scrutiny and checks and balances which operate in other federal program areas.

The Committee notes several trends in intelligence budgeting and management which indicate an increasing need for strong and objective OMB staff assistance to the President: first, intelligence spending has increased significantly in the last decade. There are pressures for further growth; second, as already noted, intelligence is one of the few "controllable" program areas of a federal budget; third, the results of intelligence spending do not seem to be commensurate with the increases in outlays. Inflation partly explains this. Since 1969 the real value of goods and services available to intelligence has been reduced by an estimated twenty percent. Inflation is not a full explanation, however. Rigidities in the intelligence budget protect each manager's share, at the cost of perpetuating less productive or duplicative programs. The result is that ceilings on the intelligence budget are permitted to drive out long-term improvements in economy and effectiveness. Fourth, there is a fragmentation of management authority in the intelligence community. The DCI has had successive presidential mandates to manage, but has been handicapped by the lack of control of intelligence dollars.

In the face of such a challenge, the nature of future presidential mandates to OMB could be important to both executive and congressional oversight. In any future determination to strengthen OMB's role, it will be necessary to enlarge the staff of the six-person OMB intelligence unit.

9. OMB's Role as Affected by the President's Recent Executive Order

In his Executive Order of February 18, President Ford strengthened OMB's role in intelligence management in two principal ways: First, OMB has been made an observer to the Operations Advisory Group, successor to the 40 Committee. This step will likely give OMB

a regular and timely scrutiny of all proposed covert action and other sensitive intelligence projects. OMB's review will, therefore, no longer be confined to a postdecision review of those projects requiring Contingency Reserve Fund financing. Another likely effect is to strengthen the *substantive* mandate of OMB's inquiry into CIA projects of *all* kinds.

Second, the President has given the DCI a more direct influence on the national intelligence budget by requiring that the new Committee on Foreign Intelligence (CFI), which is headed by the DCI, "shall control budget preparation and resource allocation for the National Foreign Intelligence Program." Further, the President requires that the CFI "shall, *prior to submission to the Office of Management and Budget*, review, and amend as it deems appropriate, the budget for the National Foreign Intelligence Program." [Emphasis added.]

The combined effect of these two changes would appear to strengthen OMB's review role. The directive appears to tackle the problem of the weak and ill-timed impact of DCI review; it also puts OMB in the position of evaluating the analyses and proposals of both the CFI and the intelligence agencies on the way to the President.

The managerial flaws in the President's Executive Order are these:

1. The President's directive that "neither the DCI nor the CFI shall have responsibility for tactical intelligence" exempts what may be one of the largest and managerially vulnerable areas of intelligence from national management and beneficial tradeoffs. It gives Defense a dodge that could defeat future DCI and OMB management efforts. By failing to make the distinction between *operational* control of intelligence organic to military units and *management overview* (i.e., maintenance of DCI/CFI data base, continuing overview, and occasional initiatives), the President's directive may have undercut much of the DCI/OMB managerial clout.⁴⁴

2. The silence of the Executive Order on *execution* of the intelligence budget fails to mandate CFI and OMB apportionment of funds appropriated for intelligence and GAO audit. The Order does give the CFI authority to control "resource allocation." If this is interpreted to mean a system of centralized CFI apportionment via OMB, executive oversight of national intelligence programs could be strengthened. The meaning of these words in the Executive Order therefore deserves probing.

3. The *actual* authority of the DCI in the new Committee on Foreign Intelligence may not be very strong in practice because the Executive Order does nothing about the pattern of intelligence appropriations. Defense still receives eighty percent of the national intelligence budget. The Order recognizes the Secretary of Defense as responsible for directing, funding, and operating "NSA and national, defense, and military intelligence and reconnaissance activities as required." The Secretary of Defense remains the "executive agent of the U.S. Government" for signals intelligence. In view of these formidable DOD powers, the CFI may be dominated by—or at least subject to the veto of—the Department of Defense.

⁴⁴ See Congressional study, *Congressional Oversight of the Intelligence Budget*, Parts I and II.

V. THE DIRECTOR OF CENTRAL INTELLIGENCE

ISSUES

In January 1946, President Truman established by Presidential Directive the National Intelligence Authority under the direction of the Director of Central Intelligence (DCI). The Directive authorized the Director of Central Intelligence to plan, develop and coordinate the foreign intelligence activities of the United States Government.¹ That same year, the Joint Congressional Committee on the Investigation of the Pearl Harbor Attack described how the military services in Washington had failed to bring all the intelligence together about Japanese plans and intentions and then concluded that "operational and intelligence work requires centralization of authority and clear-cut allocation of responsibility."²

Subsequently, in 1947, Congress passed the National Security Act giving the DCI responsibility for "coordinating the intelligence activities of the several Government departments and agencies in the interest of national security."³ Concurrently, the President designated the Director of Central Intelligence as his principal foreign intelligence adviser and established an Intelligence Advisory Committee (later reconstituted as the United States Intelligence Board) to "advise" the DCI in carrying out his responsibilities.⁴

The precise roles and responsibilities of the DCI, however, were not clearly spelled out. For fear of distracting attention from the principal objective of the 1947 National Security Act—to unify the armed services—the White House did not delineate the DCI's functions in any detail.⁵ The Congressional debates also failed to address the extent

¹ Presidential Directive, 1/22/46, *Federal Register*, Vol. II, pp. 1337, 1339.

² Joint Committee on the Investigation of the Pearl Harbor Attack, *Report*, pursuant to S. Con. Res. 27, 7/20/46, 79th Cong., 2nd Sess., p. 254.

³ Section 102, National Security Act of 1947, 61 Statutes-at-large 497-499. Provisions of Section 102 are codified at 50 U.S.C. 403.

⁴ National Security Council Intelligence Directive (NSCID) No. 1, 12/12/47. The Intelligence Advisory Committee was chaired by the DCI, and was composed of representatives from the Departments of State, Army, Navy, and Air Force, the Joint Chiefs of Staff, and the Atomic Energy Commission. In 1957, the President's Foreign Intelligence Advisory Board recommended that the Intelligence Advisory Committee be merged with the United States Communications Intelligence Board to perform the overall intelligence coordinating function more effectively. Consequently, the United States Intelligence Board (USIB) was established in 1958.

⁵ Under President Ford's Executive Order No. 11905, 2/18/76, USIB was dissolved, but the DCI was given responsibility to "establish such committees of collectors, producers and users of intelligence to assist in his conduct of his responsibilities."

⁶ Draft Legislative History of the CIA, prepared by the Office of Legislative Counsel, CIA, July, 1967; and *Organizational History of CIA, 1950-1953*, prepared by the CIA, p. 27.

of DCI authority over the intelligence community. Rather, congressional committees were interested in whether the DCI's primary responsibility would be to the military services or whether he would report directly to the National Security Council (NSC) and the President.⁶ But the problems facing the DCI were obvious from the beginning. According to a 1948 memorandum by the CIA's General Counsel:

In its performance of the intelligence functions outlined in the National Security Act, the primary difficulty experienced by CIA has been in certain weakness of language in paragraph 102(d) concerning the meaning of coordination of intelligence activities. Where the Act states "it shall be the duty of the Agency . . . to advise the National Security Council . . . [and] to make recommendations to the National Security Council for the coordination of such intelligence activities," it has been strongly argued that this places on the Director a responsibility merely to obtain cooperation among the intelligence agencies. This weakness of language and the ensuing controversy might have been eliminated by the insertion after the phrase "it shall be the duty of the Agency," the following words: "and the Director is hereby empowered," or some other such phrase indicating the intent of Congress that the Director was to have a controlling voice in the coordination, subject to the direction of the National Security Council.⁷

Under Senate Resolution 21, the Select Committee has undertaken for the first time since 1947 a study of the manner in which the successive Directors of Central Intelligence have carried out their responsibilities, in an effort to determine: (1) whether the DCI's assigned responsibilities are proper and sufficient; (2) whether the DCI has sufficient authority to carry out these responsibilities; (3) whether the DCI should continue as Director of the Central Intelligence Agency, if he is to play a leadership role for the entire intelligence community; and (4) whether Congress should enact more explicit or different definitions of the DCI's responsibilities.

⁶ Hearings before the Senate Armed Services Committee on S. 758, pp. 178-178, and Hearings before the House Committee on Expenditures in the Executive Departments on H.R. 2139 (1947). During the House hearings, Representative Hale Boggs commented:

"I can see . . . even if this bill becomes law, as presently set up, a great deal of room for confusion on intelligence matters. Here we have the Director of the Central Intelligence Agency, responsible to the National Security Council, and yet the Director is not a member of that Council, but he has to get all of his information down through the chair of the Secretary of National Defense, and all the other agencies of Government in addition to our national defense agencies. . . . I just cannot quite see how the man is going to carry out his functions there without a great deal of confusion, and really more opportunity to put the blame on somebody else than there is now."

Secretary of the Navy James Forrestal replied:

"Well, if you have an organization, Mr. Boggs, in which men have to rely upon placing the blame. . . . you cannot run any organization, and it goes to the root really of this whole question. *This thing will work, and I have said from the beginning it would only work, if the components want it to work.*" [Emphasis added.]

⁷ Memorandum from Lawrence R. Houston to the Director, 5/7/48.

INTRODUCTION

The Pearl Harbor intelligence failure was the primary motivation for establishing a Director of Central Intelligence. President Truman desired a national intelligence organization which had access to all information and would be headed by a Director who could speak authoritatively for the whole community and could insure that the community's operation served the foreign policy needs of the President and his senior advisers.⁸ President Truman and subsequent Presidents have not wanted to rely exclusively on the intelligence judgments of departments with vested interests in applying intelligence to support a particular foreign policy or to justify acquiring a new weapons system.

However, the DCI's responsibility to produce national intelligence and to coordinate intelligence activities has often been at variance with the particular interests and prerogatives of the other intelligence community departments and agencies. During the Second World War, the Department of State and the military services developed their own intelligence operations. Despite establishment of the Director of Central Intelligence in 1946, they have not wanted to give up control over their own intelligence capabilities. The military services particularly have argued that they must exercise direct control over peacetime intelligence activities in order to be prepared to conduct wartime military operations. The State and Defense Departments have steadfastly opposed centralized management of the intelligence community under the DCI.

However, over time the actual degree of conflict between the DCI's responsibility to coordinate intelligence activities and the interests of the other parts of the community has depended on how broadly each DCI chose to interpret his coordination responsibilities and how he allocated his time between his three major roles.⁹ The three roles the DCI plays are: (1) the producer of national intelligence; (2) the coordinator of intelligence activities; and (3) the Director of the Central Intelligence Agency.

A. THE PRODUCER OF NATIONAL INTELLIGENCE

As the President's principal foreign intelligence adviser, the DCI's major responsibility is to produce objective and independent *national*

⁸ Harry S. Truman, *Memoirs*, Vol. II, p. 58.

⁹ QUESTION: When you were DCI, did you feel that institutionally or functionally your position was bumping heads with the DOD intelligence apparatus in different ways or not, and if not, why not, in view of the structure?

MR. SCHLESINGER: Well, historically there have been intervening periods of open warfare and detente. . . . Prior to these, one of the problems of the intelligence community has been the warfare that exists along jurisdictional boundaries, and this tended to erupt in the period of the 1960's, in particular when they were introducing a whole set of new technical collection capabilities; that open warfare was succeeded by a period of true detente, but the problem with such detente is that it tends to be based on marriage contracts and the principle of good fences make good neighbors, and that a mutual back-scratching and the like, so that you do not get effective resource management under those circumstances. (James Schlesinger, testimony, 2/2/76, pp. 29-30.)

intelligence for senior policymakers.¹⁰ In so doing, he draws on a variety of collection methods and on the resources of the departmental intelligence organizations as well as CIA analysts.¹¹ But the DCI issues national intelligence and is alone responsible for its production.¹²

The most important national intelligence which the DCI produces is the National Intelligence Estimate (NIE). An NIE presents the intelligence community's current knowledge of the situation in a particular country or on a specific topic and then tries to estimate what is going to happen within a certain period of time. NIEs are prepared for use by those in the highest policy levels of government and represent the considered judgment of the entire community.¹³ Major differences of opinion within the intelligence community are illuminated in the text or in the footnotes. When an NIE is released, however, it is the DCI's own national intelligence judgment, in theory free from departmental or agency biases.¹⁴

To carry out this responsibility to produce independent and objective national intelligence, DCI Walter Bedell Smith established the Board of National Estimates in 1950. The Board was comprised of senior government officials, academicians and intelligence officers and had a small staff known as the Office of National Estimates (ONE). One member of the Board would be responsible for supervising the drafting of the estimates by the ONE staff, for reviewing these judgments collectively for the DCI, and for adjudicating disputes within the community. When the United States Intelligence Board reviewed an NIE, the DCI could have confidence in the opinions expressed in the estimate because each estimate reflected the collective judgment of his own Board. According to the former chairman of the Board of National Estimates, John Huizenga:

The Board of National Estimates in fact functioned as a kind of buffer. It provided procedures by which the departmental views could be given a full and fair hearing, while at the same time ensuring that the DCI's responsibilities to produce intelligence from a national viewpoint could be upheld.¹⁵

¹⁰ According to NSCID No. 1, 2/17/72, national intelligence is that intelligence required for the formulation of national security policy and concerning more than one department or agency. It is distinguished from departmental intelligence, which is that intelligence in support of the mission of a particular department.

¹¹ Prior to President Ford's Executive Order No. 11905, 2/18/76, the United States Intelligence Board, composed of representatives from the various agencies and departments of the intelligence community, formally reviewed the DCI's national intelligence judgments.

¹² Under President Ford's Executive Order No. 11905, 2/18/76, the DCI will have responsibility to "supervise production and dissemination of national intelligence."

¹³ At present, the DCI briefs the Congress on the judgments contained in his NIEs. The Congress does not receive the DCI's NIEs on a regular basis.

¹⁴ In his role as CIA Director, the DCI also produces current intelligence and research studies for senior policymakers. These intelligence judgments are prepared by CIA analysts who are supposed to be free from departmental preferences. Such current reporting is not formally reviewed by the other members of the intelligence community, but is often informally coordinated.

¹⁵ John Huizenga testimony, 1/20/76, p. 11.

In 1973, Colby replaced the Board and the ONE staff with a new system of eleven National Intelligence Officers (NIOs). Each NIO has staff responsibility to the DCI for intelligence collection and production activities in his geographical or functional specialty. The NIOs coordinate the drafting of NIEs within the community. They do not, however, collectively review the final product for the DCI.¹⁶ Director Colby testified that he thought the Board of National Estimates tended to fuzz over differences of opinion and to dilute the DCI's final intelligence judgments.¹⁷

In the course of its investigation, the Committee concluded that the most critical problem confronting the DCI in carrying out his responsibility to produce national intelligence is making certain that his intelligence judgments are in fact *objective* and *independent* of departmental and agency biases. However, this is often quite difficult. A most delicate relationship exists between the DCI and senior policymakers. According to John Huizenga :

There is a natural tension between intelligence and policy, and the task of the former is to present as a basis for the decisions of policymakers as realistic as possible a view of forces and conditions in the external environment. Political leaders often find the picture presented less than congenial. . . . Thus, a DCI who does his job well will more often than not be the bearer of bad news, or at least will make things seem disagreeable, complicated, and uncertain. . . . When intelligence people are told, as happened in recent years, that they were expected to get on the team, then a sound intelligence-policy relationship has in effect broken down.¹⁸

In addition, the DCI must provide intelligence for cabinet officers who often have vested interests in receiving information which supports a particular foreign policy (State Department) or the acquisi-

¹⁶ Under the NIO system, the Defense Intelligence Agency (DIA) and the military services have assumed greater responsibility for the initial drafting of military estimates. Because NIOs have no separate staff, they must utilize experts in the community to draft sections of the estimates. In 1975, DIA prepared the first drafts of two chapters of the NIE on Soviet offensive and defensive strategic forces. Colby contends that as a consequence, analysts throughout the community felt more involved. (William Colby testimony, 12/11/75.)

¹⁷ According to Colby :

"A board? You say why don't you have a board also? I have some reservation at the Ivory tower kind of problem that you get out of a board which is too separated from the rough and tumble of the real world. I think there is a tendency for it to intellectualize and then write sermons and appreciations. . . .

"I think there is a tendency to become institutionally committed to an approach and to an appraisal of a situation and to begin to interpret new events against the light of a predetermined approach toward those events. I think that has been a bother. I like the idea of an individual total responsibility, one man or woman totally responsible, and then you don't get any fuzz about how there was a vote, and therefore I really didn't like it but I went along and all that sort of thing, one person totally responsible, I think, is a good way to do it. That can be the Director or whatever you set up. But I do like that idea of separating out and making one individual totally responsible so there's nobody else to go to, and there's no way of dumping the responsibility onto somebody else. That really is my main problem with the board, that it diffuses responsibility, that it does get out of the main line of the movement of material. (Colby, 12/11/75, pp. 36-37.)

¹⁸ Huizenga, 1/26/76, pp. 12-13.

tion of a new weapon system (Department of Defense).¹⁹ The President and NSC staff want confirmation that their policies are succeeding. Moreover, each NIE has in the past been formally reviewed by other members of the intelligence community. Although CIA analysts have developed expertise on issues of critical importance to national policymakers, such as Soviet strategic programs, most DCIs have been reluctant to engage in a confrontation with members of the USIB over substantive findings in national intelligence documents.²⁰ According to John Huizenga:

The truth is that the DCI, since his authority over the intelligence process is at least ambiguous, has an uphill struggle to make a sophisticated appreciation of a certain range of issues prevail in the national intelligence product over against the parochial views and interests of departments, and especially the military departments.²¹

Finally, the DCI's own analysts in CIA are sometimes accused of holding an "institutional" bias. According to James Schlesinger:

The intelligence directorate of the CIA has the most competent, qualified people in it, just in terms of their raw intellectual capabilities, but this does not mean that they are free from error. In fact, the intelligence directorate tends to make a particular type of error systematically in that the intelligence directorate tends to be in close harmony with the prevailing biases in the intellectual community, in the university community, and as the prevailing view changes in that community, it affects the output of the intelligence directorate.²²

In particular, CIA analysts are sometimes viewed as being predisposed to provide intelligence support for the preferences of the arms control community. According to Schlesinger:

For many years it was said, for example, that the Air Force had an institutional bias to raise the level of the Soviet threat, and one can argue that in many cases that it did and that was a consequence.

¹⁹ According to Huizenga:

"It should be recognized that the approach of an operating department to intelligence issues is not invariably disinterested. The Department of State sometimes has an interest in having intelligence take a certain view of a situation because it has a heavy investment in an ongoing line of policy, or because the Secretary has put himself on record as to how to think about a particular problem. In the Defense Department, intelligence is often seen as the servant of desired policies and programs. At a minimum there is a strong organizational interest in seeing to it that the intelligence provides a vigorous appraisal of potential threats. It is not unfair to say that because of the military leadership's understandable desire to hedge against the unexpected, to provide capabilities for all conceivable contingencies there is a natural thrust in military intelligence to maximize threats and to oversimplify the intentions of potential adversaries. It is also quite naturally true that military professionals tend to see military power as the prime determinant of the behavior of states and of the movement of events in international politics." (Huizenga, 1/26/70, pp. 11-12.)

²⁰ *Ibid.*, p. 11.

²¹ *Ibid.*, p. 12.

²² Schlesinger, 2/2/70, pp. 24-25.

But there developed an institutional bias amongst the analytic fraternity which ran in the opposite direction. There was an assumption that the Soviets had the same kind of arms control objectives that they wished to ascribe or persuade American leaders to adopt, and as a result there was a steady upswing of Soviet strategic capabilities, and the most serious problem, it seems to me, or the most an using problem developed at the close of the cycle when the Soviets had actually deployed more than 1,000 ICBMs, and the NIEs, as I recall it, were still saying that they would deploy no more than 1,000 ICBMs because of the prevailing belief in the intelligence analytic fraternity that the Soviets would level off at 1,000 just as we had.

So one must be careful to balance what I will call the academic biases amongst the analysts with the operational biases amongst other elements of the intelligence community.²³

Consequently, on the occasions when the DCI does support his own staff's recommendations over the objection of the other departments, the objectivity of the national intelligence product may still be undermined by the bias of CIA analysts.

Recognizing all these difficulties, the Select Committee has investigated two particularly difficult cases for Director Helms in an effort to illustrate the problems the DCI confronts in carrying out his responsibility to produce objective and independent national intelligence.

During the summer and fall of 1969, the White House and then the Secretary of Defense indirectly pressured the DCI to modify his judgments on the capability of the new Soviet SS-9 strategic missile system. The issues under debate were: (1) whether the SS-9 was a MIRV (Multiple Independently Targetable Re-entry Vehicle) missile; and (2) whether the Soviets were seeking to achieve a first strike capability. The intelligence judgments on these points would be critical in decisions as to whether the United States would deploy its own MIRV missiles or try to negotiate MIRV limitations in SALT (the Strategic Arms Limitation Talks), and whether the United States would deploy an Anti-Ballistic Missile (ABM) system to protect the United States Minuteman missile force against a Soviet first strike.

On the first issue, in June 1969, the President's Special Adviser for National Security Affairs, Henry Kissinger, called Director Helms to the White House to discuss an estimate on Soviet strategic forces. Kissinger and the NSC staff made clear their view that the new Soviet missile was a MIRV and asked that Helm's draft be rewritten to provide more evidence supporting the DCI's judgment that the SS-9 had *not* demonstrated a MIRV capability. In response, the Chairman of the Board of National Estimates rewrote the draft, but he did not change the conclusion: All seven tests of the SS-9 were MRVs (Multiple Re-entry Vehicles); they were certainly not independently guided after

²³ Schlesinger, 2/2/76, pp. 23-27. CIA analysts are also sometimes accused of being biased in favor of the clandestine intelligence collected by their own agency. This charge is not, however, supported by a CIA study of what kinds of reporting CIA analysts themselves find KEY in writing their intelligence memoranda. For FY 1974, while CIA analysts considered clandestine reporting to be important, overt State Department reporting on political and economic subjects was cited more frequently as KEY. (*Annual DDI Survey, FY 1974*.)

separation from the launch vehicle.²⁴ According to testimony by three Board members, at the time they saw nothing improper in a White House request to redraft the estimate to include more evidence. However, in this case, they interpreted the White House request as a subtle and indirect effort to alter the DCI's national intelligence judgment.²⁵

On the second issue, three months later, Helms decided to delete a paragraph in the Board of National Estimates' draft on Soviet strategic forces after an assistant to Secretary of Defense Laird informed Helms that the statement contradicted the public position of the Secretary.²⁶

The deleted paragraph read:

We believe that the Soviets recognize the enormous difficulties of any attempt to achieve strategic superiority of such order as to significantly alter the strategic balance. Consequently, we consider it highly unlikely that they will attempt within the period of this estimate to achieve a first-strike capability, i.e., a capability to launch a surprise attack against the U.S. with assurance that the USSR would not itself receive damage it would regard as unacceptable. For one thing, the Soviets would almost certainly conclude that the cost of such an undertaking along with all their other military commitments would be prohibitive. More important, they almost certainly would consider it impossible to develop and deploy the combination of offensive and defensive forces necessary to counter successfully the various elements of U.S. strategic attack forces. Finally, even if such a project were economically and technically feasible the Soviets almost certainly would calculate that the U.S. would detect and match or overmatch their efforts.²⁷

Subsequently, the State Department representative on the United States Intelligence Board inserted the deleted paragraph as a footnote.

²⁴ In a memorandum to the USIB representatives, dated 6/16/69, the Director of the Office of National Estimates, Abbot Smith, stated:

"The Memorandum to Holders of NIE 11-8-68, approved by USIB on 12 June was discussed at a meeting with Dr. Kissinger and others on Saturday. Out of this meeting came requests for (a) some reordering of the paper; (b) clarification of some points; and (c) additional argument pro and con about the MRV-MIRV problem. We have accordingly redrafted the paper with these requests in mind. No changes in estimates were asked, nor (we think) have been made. But the details call for coordination."

See also, staff summary of Carl Duckett interview, 6/18/75.

²⁵ Staff summaries of interviews with John Huizenga, 7/0/75; Abbot Smith, 8/2/75; Williard Mathias, 7/7/75.

²⁶ Memorandum from Director Helms to USIB Members, 9/4/69, and staff summary of Abbot Smith interview, 8/2/75.

According to William Baroody, Secretary Laird's Special Assistant:

"I am fairly confident that I did not specifically bring pressures to bear on the Director of Central Intelligence to delete or change any particular paragraph. We did discuss the difference, at the time between, as these documents refresh my memory, between the DIA concern of that particular paragraph and the CIA estimate." (William Baroody testimony, 2/27/76, p. 4.)

²⁷ Draft NIE 11-8-69, approved by the Board of National Estimates prior to the USIB meeting on August 28, 1969.

These are stark, and perhaps exceptional, examples of White House and Defense Department pressures on the DCI, but they illustrate the kinds of buffeting with which the DCI must contend. Director Helms testified:

A national intelligence estimate, at least when I was Director, was considered to be the Director's piece of paper. USIB contributed to the process but anybody could contribute to the process, the estimates staff, individuals in the White House. And the fact that a paragraph or a sentence was changed or amended after USIB consideration was not extraordinary. . . .

So this question which seems to have come up about somebody influencing one aspect or influencing another aspect of it, the whole process was one of influences back and forth, some in favor of this and some in favor of that. . . .

So that was the system then. I don't know what is the system now, but on this issue of the first strike capability one of the things that occurred in connection with that was a battle royale over whether it was the Agency's job to decide definitively whether the Soviet Union had its first strike capability or did not have a first strike capability. And this became so contentious that it seemed almost impossible to get it resolved.

I have forgotten just exactly what I decided to do about the whole thing, but I don't know, I think it was back in '69. There was a question about certain footprints and MRVs and things of this kind, and some people felt that they were very important footprints and other people thought they were unimportant footprints, and there's no question there's a battle royale about it.

However, it was resolved however. If you felt that there was pressure to eliminate one thing, there was a manifold pressure to put in something else.

But anyway, I don't really see an issue here.²⁸

While Helms may not see an issue here, the Committee found that constant tension exists between the DCI, whose responsibility it is to produce independent and objective national intelligence, and the agencies, who are required to cooperate in this effort.

A second case investigated by the Select Committee illustrates the potential problems the DCI confronts in producing relevant national intelligence for senior policymakers planning highly sensitive military operations. In April 1970, following Prince Sihanouk's ouster, United States policymakers decided to initiate a military incursion into Cambodia to destroy North Vietnamese sanctuaries. In making this decision, these policymakers had to rely on an earlier (February) NIE and current reporting from the various departments and agencies. They never received a formal DCI national intelligence estimate or memorandum on the political conditions inside Cambodia after Sihanouk's departure or on the possible consequences of such an American incursion. Why? Because Director Helms decided in April not to send such an estimate to the NSC.

²⁸ Richard Helms testimony, 1/30/76, pp. 59-61.

In April 1970, analysts in the Office of National Estimates prepared a long memorandum entitled "Stocktaking in Indochina: Longer Term Prospects" which included discussion of the broad question of future developments in Cambodia, and addressed briefly the question of possible United States intervention:²⁹

Nevertheless, the governments of Laos and Cambodia are both fragile, and the collapse of either under Communist pressure could have a significant adverse psychological and military impact on the situation in South Vietnam. . . . Because the events in Cambodia and their impact are harder to predict, if Hanoi could be denied the use of base areas and sanctuaries in Cambodia, its strategy and objectives in South Vietnam would be endangered. Hanoi is clearly concerned over such a prospect. Cambodia, however, has no chance of being able to accomplish this by itself; to deny base areas and sanctuaries in Cambodia would require heavy and sustained bombing and large numbers of foot soldiers which could only be supplied by the U.S. and South Vietnam. Such an expanded allied effort could seriously handicap the Communists and raise the cost to them of prosecuting the war, but, however successful, it probably would not prevent them from continuing the struggle in some form.³⁰

Helms received this draft memorandum 13 days before the planned United States incursion into Cambodia. Then the day before the incursion began, Helms decided not to send the memorandum to the White House. A handwritten note from Helms to the Chairman of the Board of National Estimates stated: "Let's take a look at this on June 1, and see if we would keep it or make certain revisions."

The Committee has been unable to pinpoint exactly why Director Helms made this decision.³¹ One member of the Board of National Estimates recalled that Helms would have judged it "most counter-productive" to send such a negative assessment to the White House.³² George Carver, Director Helms' Special Assistant for Vietnamese Affairs in 1970, objected to this conclusion that Helms refrained from sending the memorandum forward because he thought the message

²⁹ DCI Helms encouraged the analysts to prepare such a memorandum for the White House. On an early draft, Helms commented to Abbot Smith, Chairman of the Board of National Estimates: "O.K. Let's develop the paper as you suggest and do our best to coordinate it within the Agency. But in the end I want a good paper on this subject, even if I have to make the controversial judgments myself. We owe it to the policymakers I feel." (Richard Helms, 4/7/70.)

³⁰ "Stocktaking in Indochina: Longer Term Prospects," ONE memorandum, 4/17/70, para. 60.

³¹ Helms told the Committee:

"Unfortunately my memory has become hazy about the reasons for decisions on the papers you identify. . . . In a more general way let me try to be helpful to you (I will assume that you have or will talk to [George] Carver and that you will give reasonable weight to his comments. In the first place, it is almost impossible at this late date to recreate all the relevant circumstances and considerations which went into decisions of the kind you are examining, made six years ago. Secondly, it is dangerous to examine exhaustively one bead to the exclusion of other beads in the necklace." (Telegram from Richard Helms to the Select Committee, 3/23/76.)

³² staff summary of James Graham interview, 2/5/76.

would be unpalatable or distressing to the White House.³³ Rather, Carver argued that Helms judged that it would not be appropriate to send forward a memorandum drafted by analysts who did not know about the planned U.S. military operation.

According to Carver's testimony, Helms was told in advance about the planned incursion under the strict condition that he could not inform other intelligence analysts, including the Chairman of the Board of National Estimates and the CIA intelligence analysts working on Indochina questions. Then because the analysts were not informed, Helms decided not to send forward their memorandum on Indochina.

According to Carver:

He [Helms] thought that it might be unhelpful, it might indeed look a little fatuous, because the people who had prepared it and drafted it were not aware that the U.S. was on the verge of making a major move into Cambodia, hence their commentary was based on the kind of unspoken assumption that there was going to be no basic operational change in the situation, as they projected over the weeks and months immediately ahead.³⁴

Further, Carver speculated that Helms probably felt he would not be listened to if it were immediately open to the counterattack that the analysts did not know of the planned operations.³⁵ In effect, Carver argues that in carrying out the President's restriction on discussing the planned operations, Helms denied his analysts the very information he considered necessary for them to have to provide intelligence judgments for senior policymakers. Helms took this decision even though the memorandum in question included a *judgment* on the possible consequences of United States intervention in Cambodia.

Thus, for whatever combination of reasons, in the spring of 1970 prior to the Cambodia incursion, the DCI did not provide senior policymakers formally with a national intelligence memorandum which argued that the operation would not succeed in thwarting the North Vietnamese effort to achieve control in Indochina.

Six weeks later, while the Cambodia incursion was still underway, the State Department requested a Special NIE (SNIE) on North Vietnamese intentions which would include a section on the impact of the United States intervention in Cambodia. A draft estimate was prepared and coordinated within the intelligence community, just as the incursion was ending. The estimate began with a number of caveats such as: "Considerable difficulties exist in undertaking this analysis at this time. Operations in Cambodia are continuing and the data on results to date is, in the nature of things, incomplete and provisional." The draft went on to say that assessing Hanoi's intentions is always a difficult exercise but "even more complicated in a rapidly moving situ-

³³ George Carver testimony, 3/5/70, p. 80.

³⁴ *Ibid.*, p. 10. Carver told the Committee that his overall judgments were "based on what I am reasonably convinced is a recollection of a series of conversations, although I cannot cite to you a specific conversation or give you a Memorandum for the Record that says that." (*Ibid.*, p. 15.)

³⁵ *Ibid.*, pp. 22-23.

ation, in which there are a number of unknown elements, particularly with respect to U.S. and Allied courses of action." With respect to the situation in Cambodia, the estimate concluded:

Although careful analysis of these losses suggests that the Communist situation is by no means critical, it is necessary to retain a good deal of caution in judging the lasting impact of the Cambodian affair on the Communist position in Indochina.³⁵

Despite all these qualifications, Helms again decided not to send the estimate to the White House. While Helms does not recall the reasons for his decision, he did tell the Committee:

In my opinion there is no way to insulate the DCI from unpopularity at the hands of Presidents or policymakers if he is making assessments which run counter to administrative policy. That is a built-in hazard of the job. Sensible Presidents understand this. On the other hand they are human too, and in my experience they are not about to place their fate in the hands of any single individual or group of individuals. In sum, make the intelligence estimates, be sure they reach the President personally, and use keen judgment as to the quantity of intelligence paper to which he should be subjected. One does not want to lose one's audience, and this is easy to do if one overloads the circuit. No power has yet been found to force Presidents of the United States to pay attention on a continuing basis to people and papers when confidence has been lost in the originator.³⁶

Nevertheless, as John Huizenga testified:

In times of political stress on intelligence, there is more a question of invisible pressures that might cause people to feel that they were being leaned upon, even though nobody asked them to make out some words or add some words . . . When intelligence producers have a general feeling that they are working in a hostile climate, what really happens is not so much that they tailor the product to please, although that's not been unknown, but more likely, they avoid the treatment of difficult issues.³⁷

In the end, the DCI must depend on his position as the President's principal intelligence adviser or on his personal relationship with the President to produce objective and independent national intelligence.³⁸ Organizational arrangements such as the Board of National Estimates may, nevertheless, help insulate the DCI from pressures; but

³⁵ Draft SNIE 14-3-70.

³⁶ Telegram from Richard Helms to the Select Committee, 3/23/76.

³⁷ Huizenga, 1/26/76, pp. 20-21.

³⁸ John Huizenga testified that "there were very few instances of gross interference." While "it's fair to say [the Cambodia and 38-0 cases] were gross, particularly the 38-0 case," objectivity and independence are difficult to uphold when political consensus breaks down over foreign policy issues. Huizenga concluded, "the experience of these years persuade me that we have yet to prove that we can have in times of deep political division over foreign policy a professional, independent, objective intelligence system." (Huizenga, 1/20/76, p. 9.)

only if they are used. In the cases of the SS-9 and Cambodia, Helms took the decisions without consulting with the Board collectively.

B. COORDINATOR OF INTELLIGENCE ACTIVITIES

1. *The Intelligence Process*

In theory, the intelligence process works as follows. The President and members of the NSC—as the major *consumers* of foreign intelligence—define what kinds of information they need. The Director of Central Intelligence with the advice of other members of the intelligence community establishes *requirements* for the collection of different kinds of intelligence. (An intelligence requirement is defined as a consumer statement of information need for which the information is not already at hand.) Resources are allocated both to develop new collection systems and to operate existing systems to fulfill the intelligence requirements. The collection agencies—the National Security Agency (NSA), CIA, DIA, and the military services—*manage* the actual collection of intelligence. Raw intelligence is then assembled by analysts in CIA, DIA, the State Department, and the military services and *produced* as finished intelligence for senior policymakers.

In practice, however, the process is much more complicated. The following discussion treats the Committee's findings regarding the means and methods the DCI has used to carry out his responsibility for coordinating intelligence community activities.

2. *Managing Intelligence Collection*

Although the responsibility of the DCI to coordinate the activities of the intelligence community is most general, the DCIs have tended to interpret their responsibility narrowly to avoid antagonizing the other departments and agencies in the intelligence community. While DCIs have sought to define the general intelligence needs of senior United States policymakers, they have not actually established intelligence collection requirements or chosen specific geographical targets.

The individual departments establish their own intelligence collection requirements to fulfill their perceived national and departmental needs. For example, DIA compiles the Defense Intelligence Objectives and Priorities document (DIOP) which is a single statement of intelligence requirements for use by all DOD intelligence components, in particular, Defense attaches, DIA production elements, the intelligence groups of the military services, and the military commands. The DIOP contains a listing by country of nearly 200 intelligence issues and assigns a numerical priority from one to eight to each country and topic. The State Department sends out ad hoc requests for information from United States missions abroad. Although the Department does not compile a formal requirements document, Foreign Service Officer reporting responds to the information needs of the Secretary of State.

In the absence of authority to establish intelligence requirements, the DCI relies on issuing general collection *guidance* to carry out his coordinating responsibilities. The DCI annually defines United States substantive intelligence priorities for the coming year in a DCI Directive. This sets out an elaborate matrix arraying each of 120 countries against 88 intelligence topics and assigning a numerical priority from

1 to 7 for each country and topic combination. Since 1973, the DCI has also distributed a memorandum called the DCI's "Perspectives" which defines the major intelligence problems policymakers will face over the next five years; a memorandum known as the DCI's "Objectives" which details the general resource management and substantive intelligence problems the community will face in the upcoming year; and the DCI's "Key Intelligence Questions" (KIQs) which identify topics of particular importance to national policymakers.

All these documents have in the past been reviewed by members of the intelligence community on USIB, but the DCI cannot compel the departments and agencies to respond to this guidance. For example, the Defense Intelligence Objectives and Priorities "express the spectrum of Defense intelligence objectives and priorities geared specifically to approved strategy" derived from the Joint Chiefs of Staff. But the DIOP does not include a large number of economic, political and sociological questions which the Defense Department considers inappropriate for it to cover. Consequently, Defense-controlled intelligence assets do not give priority to non-military questions even though such questions are established as priorities in the DCI's guidance.

In addition, through three intelligence collection committees of the United States Intelligence Board, DCIs have tried in the past to reconcile the different departmental requirements and to insure that the interests of the entire community are brought to bear in the intelligence collectors' operations.³⁹ The Committee on Imagery Requirements and Exploitation (COMIREX) dealt with photographic reconnaissance.⁴⁰ The SIGINT Committee coordinated the collection of signals and communications intelligence.⁴¹ The Human Resources Committee dealt with overt and clandestine human collection.⁴²

In the collection of overhead photography and signals intelligence, the DCI through the COMIREX and SIGINT Committees provides guidance as to targets and amounts of coverage. These Committees also administer a complex accounting system designed to evaluate how well, in technical terms, the specific missions have fulfilled the various national and departmental requirements. Because of the nature of overhead collection, the whole community can participate in selecting the targets and in evaluating its success. The operating agency is responsive solely to requirements and priorities established by the USIB committees. At the same time, the DCI *alone* cannot direct which photographs to take or when to alter the scope of coverage. The role of the DCI is to make sure that the preferences of the entire community are taken into account when targets are chosen.

³⁹ Under President Ford's Executive Order No. 11907, these three collection committees will probably continue under the DCI's responsibility to establish "such committees of collectors, producers, and users to assist in his conduct of his responsibilities."

⁴⁰ In 1955, Richard Bissell, a Special Assistant to the DCI, set up an informal Ad-Hoc Requirements Committee (ARC) to coordinate collection requirements for the U-2 reconnaissance program. Membership initially included representatives of CIA, the Army, Navy, and Air Force. Later representatives of NSA, the Joint Chiefs of Staff, and the State Department were added. In 1960, with the development of a new overhead reconnaissance system, the ARC was supplanted by a formal USIB Committee, the Committee on Overhead Reconnaissance or

For example, prior to the Middle East war in 1973, the USIB SIGINT committee recommended that the Middle East be a priority target for intelligence collection if hostilities broke out, and asked NSA to evaluate the intelligence collected and to determine appropriate targets. When the war broke out, NSA implemented this USIB guidance. Later in the week, the same committee discussed and approved DIA's recommendation to change the primary target of one collector. The DCI did not order the changes or direct what intelligence to collect, but through the USIB mechanism he insured that the community agreed to the retargeting of the system.

The DCI has been less successful in involving the entire intelligence community in establishing collection guidance for NSA operations or for the clandestine operations of CIA's Directorate of Operations. These collection managers have substantial latitude in choosing which activities to pursue; and the DCI has not yet established a mechanism to monitor how well these collectors are fulfilling the DCI's community guidance.

During 1975, USIB approved a new National SIGINT Requirements System, an essential feature of which requires USIB to initiate a formal community review and approval of *all* SIGINT requirements. In addition, each requirement must contain a cross reference to pertinent DCI priorities and specific KI/Qs. However, this system does

COMOR. COMOR's responsibilities included coordination of collection requirements for the development and operation of all overhead reconnaissance systems. As these programs grew and the volume of photographs increased, serious problems of duplication in imagery exploitation prompted the DCI and the Secretary of Defense to establish a special joint review group. Subsequently, it recommended the establishment of the National Photographic Interpretation Center (NPIC) and the creation of a new USIB Committee to coordinate both collection and exploitation of national photographic intelligence. In 1967, COMIREX was established.

"During World War II, the military services controlled all communications intelligence. After the war, a U.S. Communications Intelligence Board (USCIB) was established to coordinate COMINT activities for the NSC and to advise the DCI on COMINT issues. However, in 1949 the Secretary of Defense set up a separate COMINT board under the Joint Chiefs of Staff to oversee the military's COMINT activities, and this arrangement stood for three years, despite the DCI's objections. In 1952, NSA was established with operational control over COMINT resources and the Secretary of Defense was given executive authority over all COMINT activities. At the same time, the USCIB was reconstituted under the chairmanship of the DCI to advise the Director of NSA and the Secretary of Defense. In 1968, the USCIB was merged with the Intelligence Advisory Committee to form the United States Intelligence Board. The COMINT Committee of the USIB was formed soon thereafter; this became the SIGINT Committee in 1962 when its responsibilities were extended to include ELINT.

"General Bennett, Director of the Defense Intelligence Agency, proposed in 1970 the establishment of a USIB subcommittee to provide a national-level forum to coordinate the various human source collection programs, both overt and clandestine. Following objections from the CIA's Directorate of Operations, Director Helms decided instead to establish an ad hoc task force to study the whole range of HUMINT problems. After a year's study, the task force recommended the establishment of a USIB committee on a one-year trial basis. The President's Foreign Intelligence Advisory Board (PFIAB), in a separate study, also endorsed the idea. Subsequently, the Human Sources Committee was accorded permanent status in June 1974 and in 1975 its name was changed to the Human Resources Committee.

not vest in the DCI operational authority over NSA and its collection systems.⁴³ The Director of NSA will still determine which specific communications to monitor and which signals to intercept. In a crisis, the Secretaries of State and Defense and the military commanders will continue to be able to task NSA directly and inform the DCI and the SIGINT Committee afterwards.

In contrast to technical intelligence collection where the DCI has sought expanded community involvement in defining requirements, DCIs have not been very receptive to Defense Department interests in reviewing CIA's clandestine intelligence collection. In part, the DCIs have recognized the difficulty of viewing human collection as a whole, since it comprises many disparate kinds of collectors, some of which are not even part of the intelligence community. For example, Foreign Service Officers do not view themselves as intelligence collectors, despite the large and valuable contribution FSO reporting makes to the overall national human intelligence effort. In addition, the CIA's Clandestine Service (DDO) has lobbied against a USIB Human Sources Committee, fearing that it would compromise the secrecy of their very sensitive operations.⁴⁴

So DCIs, as Directors of the agency responsible for collecting intelligence clandestinely, resisted establishment of a permanent USIB committee to review human collection until 1974.⁴⁵ When established, the Committee was specifically not given responsibility for reviewing the operational details or internal management of the individual departments or agencies. In the case of "sensitive" information, departments and agencies were authorized to withhold information from the Committee and report directly to the DCI.

It is not surprising, therefore, that the Human Resources Committee has only just begun to expand community influence over human collection. The Committee issues a general guidance document called the Current Intelligence Reporting List (CIRL). Although the military makes some use of this document, the DDO instructs CIA Stations that the CIRL is provided only for reference and does not constitute collection requirements for CIA operations. The Human

⁴³ William Colby testified before the Committee:

"I think it is clear I do not have command authority over the [NSA]. That is not my authority. On the other hand, the National Security Council Intelligence Directive (CID) say that I do have the job of telling them what these priorities are and what the subjects they should be working on are." (William Colby testimony, D, 20/7), pp. 20-21.)

⁴⁴ The DCI currently exercises some control over military clandestine operations. The Chief of Station in each country is the DCI's "designated representative" and has responsibility for coordinating all military clandestine operations. In the past, the DDO has only objected if the projects were not worth the risk or duplicated a DDO operation. The Chief of Station rarely undertook to evaluate whether the military operations could be done openly or would be successful.

⁴⁵ While the DCI has final responsibility for the clandestine collection of intelligence, he still faces problems in coordinating the clandestine and technical collection programs in his own agency. Illustrative of this is the recent establishment of a National Intelligence Officer (NIO) for Special Activities to help the DCI focus DDO operations on three or four central intelligence gaps. Director Casey determined that only through a special assistant could he break down the separate cultures of DDO and technical intelligence collection and the barriers between the intelligence analysts and DDO.

Resources Committee has initiated community-wide assessments of human source reporting in individual countries which emphasize the ambassador's key role in coordinating human collection activities in the field. But the Committee has not defined a national system for establishing formal collection requirements for the various human intelligence agencies.

In summary, the DCI does not have authority to manage any collection programs outside his own agency. The DCI only issues general guidance. The departments establish their own intelligence collection requirements and the collection managers (NSA, DIA, CIA, and the military services) retain responsibility for determining precisely which intelligence targets should be covered. President Ford's Executive Order does not change the DCI role in the management of intelligence collection activities.

3. Allocating Intelligence Resources

In a 1971 directive, President Nixon asked Director Helms to plan and review all intelligence activities including tactical intelligence and the allocation of all resources to rationalize intelligence priorities within budgetary constraints.⁶ Since 1971, the DCI has prepared recommendations to the President for a consolidated national intelligence program budget. Director Helms, in his first budget recommendations, proposed a lid on intelligence spending, noting that "we should rely on cross-program adjustments to assure that national interests are adequately funded."⁷ However, prior to President Ford's Executive Order, the DCI has had no way to insure authoritatively that such objectives were realized.

The DCI has independent budget authority over *only* his own agency which represents only a small percentage of the overall national intelligence budget. As chairman of an Executive Committee or ExCom for special reconnaissance activities, the DCI has been involved in the preparation of the program budget for the development and management of the major United States technical collection systems. However, differences of opinion between the DCI and the other member of the ExCom, the Assistant Secretary of Defense for Intelligence, were referred to the Secretary of Defense for resolution. The Secretary of Defense in his budget allocated the remaining intelligence community resources.

The DCI's role in the Defense intelligence budget process was in effect that of an adviser. The DCI's "Perspectives," which analyze the political, economic, and military environment over the next five years, have had little impact on the formulation of Defense intelligence resource requirements. According to John Clarke, former Asso-

⁶ "Announcement Outlining Management Steps for Improving the Effectiveness of the Intelligence Community," November 5, 1971, 7 Pres. Docs. p. 1482. Nixon sought to enhance the role of the DCI as community leader and to give the DCI responsibility to coordinate Defense Department technical collection operations with other intelligence programs. Nixon's directive followed a comprehensive study of the intelligence community by the Office of Management and Budget (known as the Schlesinger Report) which recommended a fundamental reform in the intelligence community's decisionmaking bodies and procedures.

⁷ Director of Central Intelligence, *National Intelligence Program Memorandum*, FY 1974, p. 44.

ciate Deputy to the Director of Central Intelligence for the Intelligence Community, the "Perspectives" "did not have any great bearing on the formal guidances that the different departments having intelligence elements used in deciding how much they needed or how many dollars they required for future years."⁴⁸ The military services and DIA responded to the fiscal guidance issued by the Secretary of Defense.

The DCI's small staff of seven professionals in the Resource Review Office of the Intelligence Community Staff kept a low profile and spent most of its time gathering information on the various Defense intelligence activities. They did not provide an independent assessment of the various programs for the DCI. Consequently, the DCI rarely had sufficient knowledge or confidence to challenge a Defense Department recommendation. When the DCI did object, he generally focused on programs where he thought the Defense Department was not giving adequate priority to intelligence activities in which the President had a particular interest.

For example, partly as a result of the intense concern by the NSC staff, the DCI expended substantial effort to insure that two Air Force ships, initially built to operate on the Atlantic missile range monitoring Cape Canaveral firings, continued to be available to monitor foreign missile activities. When in 1970-1971, the number of United States missile tests decreased substantially, the Air Force proposed that both ships be retired. The DCI, in turn, requested an intelligence community study which concluded that the ships were essential for foreign intelligence purposes. Consequently, the DCI brokered an arrangement for a sharing of the ships' cost within the Department of Defense. Today, a little under 20 percent of the ship program is devoted to intelligence needs. The DCI had neither the authority to direct the retention of these Air Force ships nor sufficient resources to take over their funding for intelligence purposes to insure that they were not retired. Nevertheless, the DCI played a definite role in working out an arrangement whereby at least one ship will be available until the national intelligence requirement can be met by another means.⁴⁹

In practice, the DCI only watched over the shoulder of the Assistant Secretary of Defense for Intelligence as he reviewed the budget requests of DIA, NSA, and the military services. If the DCI wished to raise a particular issue, he had a number of possible forums. He could set up an ad hoc interagency study group or discuss the question in the Intelligence Resources Advisory Committee (IRAC).⁵⁰ He could highlight resource issues in the annual fall joint OMB-Defense Department review of the Defense budget or in his December letter to the President presenting the consolidated national intelligence budget. However, the groups were only advisory to the DCI and had no authority over the Secretary of Defense. The joint review and the

⁴⁸ John Clarke testimony, 2/5/76, pp. 15-16.

⁴⁹ According to Carl Duckett, the CIA's Deputy Director of Science and Technology, "frankly we had to fight very hard the last two years to keep the ships afloat at all." (Carl Duckett testimony, 11/10/75, pp. 100-107.)

⁵⁰ IRAC was established in 1971 to advise the DCI in preparing a consolidated intelligence program budget for the President. Members included representatives from the Departments of State and Defense, OMB, and the CIA. IRAC was abolished by President Ford's Executive Order of 2/18/76.

DCI's letter to the President occurred so late in the Defense Department budget cycle that the DCI had little opportunity to effect any significant changes.

Thus, the DCI's national budget recommendations were for the most part the aggregate figures proposed by the various Defense agencies. The DCI did not provide an independent calculated evaluation of the entire national intelligence budget. The DCI did not present the President with broad alternative options for the allocation of national intelligence resources. The DCI was not able to effect trade-offs among the different intelligence programs or to reconcile differences over priorities. Finally, the President's decisions on the intelligence budget levels were not based upon the recommendations of the DCI, but rather upon Defense Department totals. According to John Clarke:

I would have to submit that in my judgment I do not think the Presidents have used the Director's recommendations with respect to the intelligence budgets. There have been few exceptions where they have solidified behind the Director's appeal, but fundamentally he has looked to the Secretary of Defense to decide what level of intelligence activities there should be in the defense budget.⁵¹

Because the Secretary of Defense had final authority to allocate most of the intelligence budget, the DCI either had to "persuade" the Secretary to allocate Defense intelligence resources according to the Director's recommendations or take his case directly to the President. According to James Schlesinger:

... the authority of whoever occupies this post, whatever it is called comes from the President. ... To the extent that it is believed that he has the President's ear, he will find that the agencies or departments will be responsive, and if it is believed that he does not have the President's ear, they will be unresponsive.⁵²

But because the DCI must expend substantial political capital in taking a Defense budget issue to the President, he rarely has sought Presidential resolution. Over the past five years, the DCI went directly to the President only twice. Both these issues involved expensive technical collection systems, and both times the DCI prevailed.

In summary, DCIs have not been able to define priorities for the allocation of intelligence resources—either among the different systems of intelligence collection or among intelligence collection, analysis, and finished intelligence. Without authority to allocate intelligence budget resources, DCIs have been unable to insure that unwarranted duplication and waste are avoided.

4. Key Intelligence Questions

As described above, DCIs have confronted major problems in seeking to carry out their coordinating responsibilities under the 1947 National Security Act. They have not had authority to establish requirements for the collection or production of national intelligence.

⁵¹ Clarke, 2/5/76, p. 27.

⁵² Schlesinger, 2/2/76, pp. 43, 45.

They have not been able to institute an effective means to evaluate how well the community is carrying out their guidance. They have not had a mechanism to direct the allocation of intelligence resources to insure that the intelligence needs of national policymakers are met.

To help solve these problems, Director Colby instituted a new intelligence management system known as the Key Intelligence Questions (KIQs). Through formation of a limited number of KIQs, Colby tried to focus collection and production efforts on critical policymaker needs and to provide a basis for reallocating resources toward priority issues.⁶³ This section will briefly highlight the resistance which Colby's new management scheme provoked and the difficulties experienced in evaluating the overall community efforts.

The KIQ scheme had four stages. First the DCI issued the KIQs. Then the National Intelligence Officers (NIOs) with representatives from the various collection and production agencies developed a strategy to answer the individual KIQs. After surveying what information was currently available to answer the KIQs, the various agencies made commitments to collect and produce intelligence reports "against" the various KIQs. At the end of the year, the DCI evaluated the intelligence community's performance.

The KIQ management process has finished its first full year of operation and a beginning has been made to provide intelligence consumers with the opportunity to make known their priorities for intelligence collection and production. Collection managers have been brought together in developing a strategy to answer key questions and analysts have received guidance as to the kinds of reports they should produce. In addition, the DCI now has before him considerable information about how the intelligence community is focusing on intelligence questions which are important to senior national policymakers. He should be in a better position to show collection and production managers where they have failed to meet their commitments to work against individual KIQs or to spend a high percentage of their resources on KIQ-related activities.

However, while the KIQ concept is imaginative, the management tool has encountered serious problems. First, the KIQ system does not solve the DCI's problem of trying to establish priorities in intelligence collection and production. Few topics are not included under one KIQ or another. The KIQs have not yet been meshed with the existing requirements system. While the KIQs are supposed to establish collection and production requirements in lieu of the DCI's Directive on priorities, both continue to exist today. The Defense Department has not only continued to issue the DIOP but has produced its own Defense Key Intelligence Questions (DKIQs) which number over 1,000. Instead of providing a means for the DCI to establish priorities for the intelligence community, the KIQs to date have added another layer of requirements.

⁶³ In FY 1975, there were 69 KIQs drafted by the DCI's National Intelligence Officers in consultation with the NSC Intelligence Committee working group. Approximately one-third of the KIQs dealt with Soviet foreign policy motivations and military technology. The other KIQs dealt with such issues as the negotiating position of the Arabs and Israelis, the terrorist threat, etc.

Second, Colby's management scheme has met strong resistance from the collection and the production agencies. After one year it is difficult to identify many intelligence activities that have changed because of the KIQs. The KIQ Strategy Reports were issued nine months after the KIQs and tended to list collection and production activities already under way. The DCI was not in a position to direct the various members of the intelligence community to undertake commitments for different collection efforts, and the Strategy Reports rarely contained new commitments.

While all agencies participated, DIA and DDO have responded to the KIQs only insofar as they were consistent with their respective internal collection objectives. DIA's "KIQ Collection Performance Report" pointed out that "the Defense Attache system primarily responds to the DKIQs and JSOP [Joint Strategic Objectives Plan] objectives and therefore, responses to KIQs will have to maintain consistency with the two aforementioned collection guidance vehicles."⁵⁴ In fact, DIA writes its "Intelligence Collection Requests" and "Continuing Intelligence Requirements," and they are then keyed back to the relevant KIQs, somewhat as an afterthought.⁵⁵

The Deputy Director of Operations for the CIA issues his "Objectives" for the collection of clandestine human intelligence. While these are derived from the KIQs, these "Objectives" are in fact the collection requirements of the Clandestine Service. Since it takes so long to recruit agents, DDO considers it is not in a position to respond to specific KIQs dealing with near-term intelligence gaps unless a source is already in place. Moreover, DDO determined not to deflect or divert its effort to satisfy KIQs unless the questions happened to fall within DDO internal objectives.

DIA and DDO invoked the KIQs to justify their operations and budgets, however they did not appear to be shaping the programs to meet KIQ objectives. Without authority to direct resources to answer the specific Key Intelligence Questions, the DCI had little success in compelling the major collectors and producers of intelligence to respond to the KIQs, if they were unwilling. Only NSA has made a serious effort to insure that their collection requirements are responsive to the KIQs. In USIB meetings, NSA Director General Allen argued that the KIQs should be viewed as requirements for the intelligence community and the KIQ Strategy Reports should provide more detailed instructions to field elements for collection.⁵⁶

Colby's new management scheme also failed to establish a workable evaluation process. NIOs provided subjective judgments as to how well the community had answered each KIQ and an assessment of the relative contribution of each agency. Although NIOs discussed their assessments with consumers, they had no staff to conduct a systematic and

⁵⁴ DIA, "KIQ Collection Performance Report," 8/18/75.

⁵⁵ In FY 1975, only 7 percent of DIA's attaché reports responded to KIQs. Out of 2,111 attaché reports against the KIQs only 34 of the 69 were covered. According to DIA, military attachés have access to particular types of information and it would be unfair to assume they had the capability to respond to all the KIQs.

⁵⁶ Minutes of USIB meeting, 2/6/75. Approximately 70 percent of NSA's requirements for FY 1975 were KIQ-related, and about 50 percent of its operations and maintenance budget could be ascribed to the KIQs.

independent review of how well the community had answered the questions. Furthermore, NIOs did not base their evaluations on any specific kinds of information, such as all production reports or all raw intelligence collected on a particular KIQ. They commented on how well the agencies had carried out their commitments in the Strategy Reports without asking the collectors for any information about what activities they undertook or what amount of money had been spent. They merely took the collector's word that something had or had not been done. Finally, they did not develop a method to insure that the judgments of the individual NIOs were consistent with each other.

In addition, the IC Staff aggregated the amount of resources expended by the various collection and production managers in answering each KIQ and determined what problems had been encountered. However, collection and production managers prepared cost estimates of the activities expended against individual KIQs according to an imprecisely defined process. And although the IC Staff provided guidance as to how to do the calculations, the decisions as to how best to estimate costs were left to the individual agencies. Not surprisingly, the agencies employed different methods.⁵⁷ Consequently, the cost estimates were not comparable across agencies, and the IC Staff had no way of making them comparable, since they could not change the different accounting systems in the various intelligence agencies.⁵⁸

In summary, the evaluation process did not permit a comparison of total efforts and results against the KIQs on a community-wide basis. Colby lacked the necessary tools to use the KIQ management system to effect resource allocation decisions. The DCI at best was in a position to shame recalcitrants into action by pointing up stark failures in a particular agency's efforts against the KIQs. The KIQ process was only a surrogate for DCI authority to allocate the intelligence resources of the community.

Colby's frustrations in trying to direct intelligence community efforts via the KIQ process are indicative of the DCI's limited authority. Within the present intelligence structure, an effort to get the DDO and DIA to respond to what the DCI has defined as key policymaker intelligence questions met considerable resistance. Thus, the most important issue raised by the KIQ management experience is not how to refine the process but whether the DCI can really succeed in directing collection and production activities in the intelligence community toward critical policymaker needs without greater authority over the allocation of resources.

⁵⁷ For example, DIA begins with the assumption that 60 percent of the Defense attaché budget goes for collection. This figure is then multiplied by the percentage of attaché reports which responded to KIQs and the total cost expended against the KIQs was calculated to be \$1.8 million. In contrast, DDO calculates cost according to the IC Staff's recommended formula, which estimates the number of manhours devoted against the KIQs and multiplies the estimate by an average production manhour cost.

⁵⁸ In addition, while the State Department provides cost estimates of INR's intelligence production costs, it did not submit collection cost statistics, maintaining that Foreign Service reports were not intelligence collection. So the evaluation process did not provide a complete picture of intelligence collection on individual KIQs.

5. *President Ford's Executive Order*

On February 18, 1976, President Ford announced a reorganization of the intelligence community to "establish policies to improve the quality of intelligence needed for national security, to clarify the authority and responsibilities of the intelligence departments and agencies. . . ." The major change introduced by the President is the formation of the Committee on Foreign Intelligence (CFI) chaired by the DCI and reporting directly to the NSC. The CFI will have responsibility to: (1) "control budget preparation and resource allocation for the National Foreign Intelligence Program;" (2) "establish policy priorities for the collection and production of national intelligence;" (3) "establish policy for the management of the National Foreign Intelligence Program;" and (4) "provide guidance on the relationship between tactical and national intelligence."⁶⁹

It is still too soon to pass judgment as to whether the Executive Order will aid the DCI in his efforts to coordinate the activities of the intelligence community. By making the DCI chairman of the CFI, the Executive Order appears to enhance the stature of the DCI by expanding his role in the allocation of national intelligence resources. But, as in the case of the Nixon directive in 1971, the DCI appears to have been given an expanded set of responsibilities without a real reduction in the authority of other members of the intelligence community over their own operations. There exist many ambiguities in the language of the Executive Order, particularly with regard to the role of the CFI.

The CFI is given responsibility to "control budget preparation and resource allocation" for national intelligence programs, but the Secretary of Defense retains responsibility to "direct, fund, and operate NSA." The CFI is asked to "review and amend" the budget prior to submission to OMB, as if the CFI will not control the preparation of the budget but rather would become involved only after the agencies and departments independently put together their own budget. Finally, the relationship is not clear between the DCI's responsibility to "ensure the development and submission of a budget" and the CFI's responsibility to "control budget preparation."

Moreover, the specific prohibition against DCI and CFI responsibility for tactical intelligence appears to be a step backward from the 1971 Nixon directive which asked the DCI to plan and review the allocation of *all* intelligence resources. While DCIs since 1971 have not become deeply involved in such tactical intelligence questions, they have reserved the right to become involved; and on several occasions they have supported efforts to transfer money from the national Defense Department intelligence budget to the budgets of the military services, or vice versa. There are, in addition, at least theoretical trade-offs to be made between tactical and national intelligence, especially since the dividing mark between all intelligence operations has become increasingly blurred with the development of large and expensive technical collection systems.

⁶⁹ Executive Order No. 11905. Other members of the CFI will be the Deputy Secretary of Defense for Intelligence and the Deputy Assistant to the President for National Security Affairs.

C. DIRECTOR OF THE CIA

At the same time the DCI has responsibility for coordinating the activities of the entire community, he also has direct authority over the intelligence operations of the CIA. As Director, the DCI runs covert operations and manages the collection of clandestine human intelligence (Directorate of Operations); manages the collection of signals intelligence abroad and allocates resources for the development and operation of certain technical collection systems (Directorate of Science and Technology); and produces current intelligence and finished intelligence memoranda (Directorate of Intelligence).

The fact that the DCIs have also directed the operations of the CIA has had a variety of consequences. First, DCIs have tended to focus most of their attention on CIA operations. The first Directors were preoccupied with organizing and establishing CIA and with defining the Agency's role in relation to the other intelligence organizations. While Allen Dulles and Richard Helms were DCI, each spent considerable time running covert operations. John McCone focused on improving the CIA's intelligence product and developing new technical collection systems when he was Director. Admiral Raborn emphasized refining the Agency's budgetary procedures.⁶⁰

Second, by having their own capabilities to collect and produce intelligence, DCIs have been able to assert their influence over the intelligence activities of the other members of the intelligence community. John Clarke, former Associate Deputy to the DCI for the Intelligence Community, testified that Helms objected to the suggestion that CIA get rid of all its SIGINT activities because he needed "something to keep [his] foot in the door" so he could "look at the bigger problem."⁶¹ According to Clarke:

... to some degree historically, the Director's involvement has not only been based upon good, healthy competition among systems, which I think is good, but the directors have seen it as an opportunity to give them a voice at the table in judgments which have importance to their higher role, a larger role as Director of CI.⁶²

However, this ability to assert influence in turn has had another consequence: DCIs have been accused of not being able to play an objective role as community leader while they have responsibility for directing one of the community's intelligence agencies. Potential conflict exists in decisions with respect to every CIA activity. For example, on each of the two occasions that the DCI went directly to the President to object to a Defense Department budget recommendation, the DCI won Presidential support for a CIA-developed technical collection system. Such DCI advocacy raises the fundamental question of whether the DCI can indeed be an objective community leader if he is also Director of the CIA which undertakes research and development on technical collection systems. According to James Schlesinger:

There has always been concern and frequently there has been the reality that the DCI does not overlook all these

⁶⁰ Colby, 12/11/75, pp. 4-5.

⁶¹ Clarke, 2/1/76, p. 59.

⁶² *Ibid.*, pp. 59-60.

assets in a balanced way . . . as long as the DCI has special responsibility for the management of clandestine activities, that it tends to affect and to some extent contaminate his ability to be a spokesman of the community as a whole involving intelligence operations which are regarded as reasonably innocent from the purview of American life.

Components of the intelligence community other than the CIA have feared that the DCI would be tempted to expand the authority of the CIA in the collection activities relative to the other components of the intelligence community. And there has been some evidence that supports such suspicion. . . .

What I believe is at the present time you have got inconsistent expectations of the DCI. He's supposed to be the fair judge amongst the elements of the intelligence community at the same time that CIA personnel expect him to be a special advocate for the CIA. You cannot have both roles.⁶³

President Ford's Executive Order seeks in part to reduce the conflict of interest problem by establishing two Deputies to the DCI, one for intelligence community affairs and one for CIA operations. The DCI and his Deputy for community affairs will have offices in downtown Washington. Nevertheless, the DCI will continue to have an office at CIA headquarters and to have legal responsibility for the operations of the Agency and at the same time general responsibility for coordinating the activities of the entire intelligence community.

⁶³ Schlesinger, 2/2/76, pp. 3, 49.

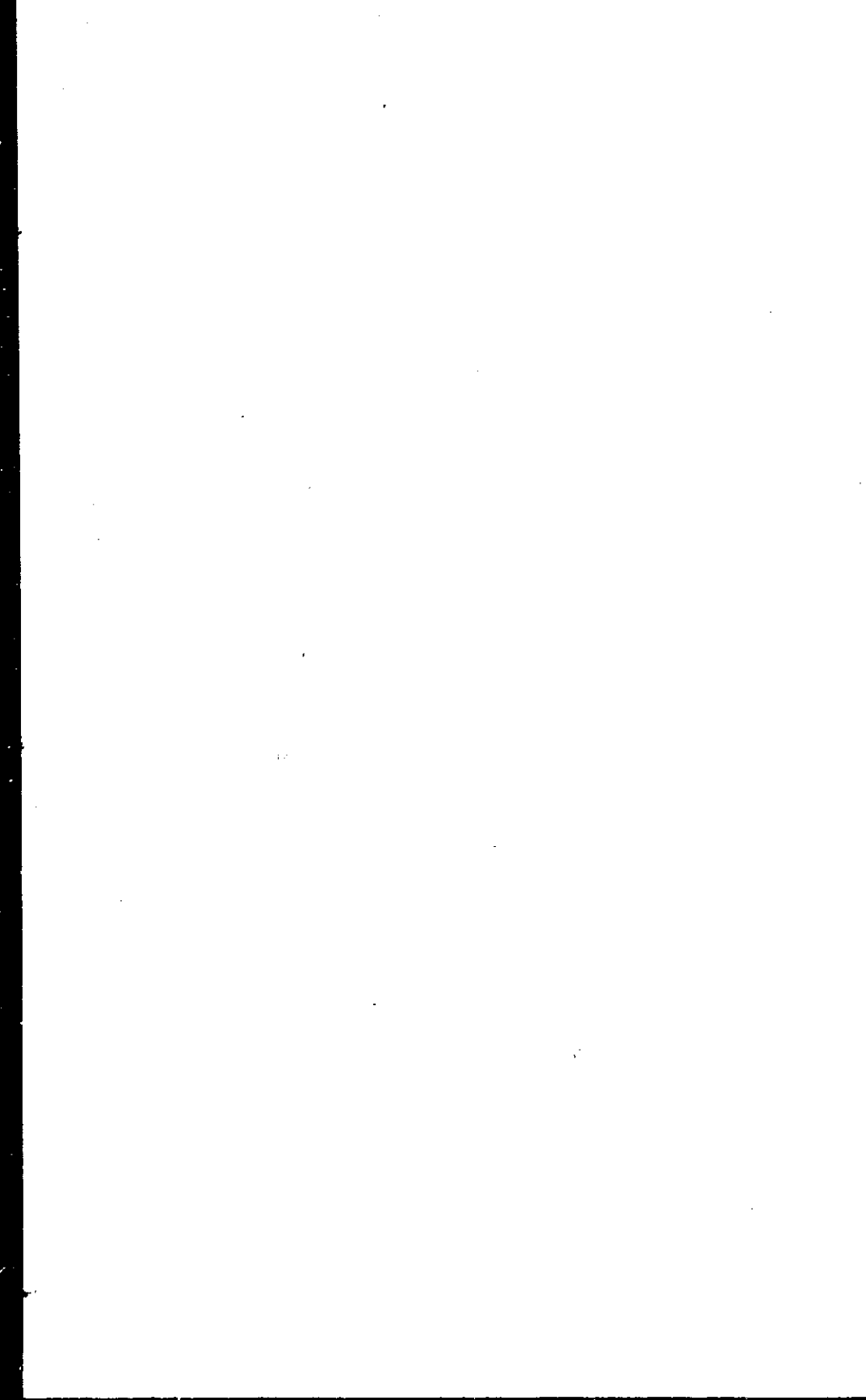

VI. HISTORY OF THE CENTRAL INTELLIGENCE AGENCY

INTRODUCTION ¹

The current political climate and the mystique of secrecy surrounding the intelligence profession have created misperceptions about the Central Intelligence Agency. The CIA has come to be viewed as an unfettered monolith, defining and determining its activities independent of other elements of government and of the direction of American foreign policy. This is a distortion. During its twenty-nine year history, the Agency has been shaped by the course of international events, by pressures from other government agencies, and by its own internal norms. An exhaustive history of the CIA would demand an equally exhaustive history of American foreign policy, the role of Congress and the Executive, the other components of the intelligence community, and an examination of the interaction among all these forces. Given the constraints of time and the need to pursue other areas of research, this was an impossible task for the Committee. Nonetheless, recognizing the multiple influences that have contributed to the Agency's development, the Committee has attempted to broadly outline the CIA's organizational evolution.

An historical study of this nature serves two important purposes. First, it provides a means of understanding the Agency's present structure. Second, and more importantly, by analyzing the causal elements in the CIA's patterns of activity, the study should illuminate the possibilities for and the obstacles to future reform in the U.S. foreign intelligence system.

The concept of a peacetime central intelligence organization had its origins in World War II with the Office of Strategic Services (OSS). Through the driving initiative and single-minded determination of General William J. Donovan, sponsor and later first director of OSS, the organization became the United States' first central intelligence body. Although OSS was disbanded in 1945 and its func-

¹ This section is the summary version of a longer history to be published as an Appendix to the Committee's Final Report. This section and the longer history are based on four principal groups of sources. Since classification restrictions prevent citing individual sources directly, the categories of sources are identified as follows: (1) approximately seventy-five volumes from the series of Internal CIA histories, a rich if uneven collection of studies, which deal with individual components of the CIA, the administrations of the Directors of Central Intelligence, and specialized areas of intelligence analysis. The histories have been compiled since the late 1940's and constitute a unique institutional memory. (2) approximately sixty interviews with present and retired Agency employees. These interviews were invaluable in providing depth of insight and understanding to the organization. (3) special studies and reports conducted both within and outside the Agency. They comprise reviews of functional areas and of the overall administration of the CIA. (4) documents and statistics supplied to the Select Committee by the CIA in response to specific requests. They include internal communications, budgetary allocations, and information on grade levels and personnel strengths.

tional components reassigned to other government agencies, the existence of OSS was important to the CIA. First, OSS provided an organizational precedent for the CIA; like OSS, the CIA included clandestine collection and operations and intelligence analysis. Second, many OSS personnel later joined the CIA; in 1947, the year of the CIA's establishment, approximately one-third of the CIA's personnel were OSS veterans. Third, OSS suffered many of the same problems later experienced by the CIA; both encountered resistance to the execution of their mission from other government agencies, both experienced the difficulty of having their intelligence analysis "heard," and both were characterized by the dominance of their clandestine operational components.

Despite the similarities in the two organizations, OSS was an instrument of war, and Donovan and his organization were regarded by many as a group of adventurers, more concerned with derring-do operations than with intelligence analysis. The post-war organization emerged from different circumstances from those that had fostered the development of OSS.

Following the War, American policymakers conceived the idea of a peacetime central intelligence organization with a specific purpose in mind—to provide senior government officials with high-quality, objective intelligence analysis. At the time of the new agency's creation, the military services and the State Department had their own independent intelligence capabilities. However, the value of their analysis was limited, since their respective policy objectives often skewed their judgments. By reviewing and synthesizing the data collected by the State Department and the military services, a centralized body was intended to produce national intelligence estimates independent of policy biases. "National" intelligence meant integrated interdepartmental intelligence that exceeded the perspective and competence of individual departments and that covered the broad aspects of national policy. "Estimates" meant predictive judgments on the policies and motives of foreign governments rather than descriptive summaries of daily events or "current intelligence."

Although policymakers agreed on the necessity for national intelligence estimates, they did not anticipate or consider the constraints that would impede achievement of their objective. As a result, the CIA assumed functions very different from its principal mission, becoming a competing producer of current intelligence and a covert operational instrument in the American cold war offensive.

The establishment of the Central Intelligence Agency coincided with the emergence of the Soviet Union as the antagonist of the United States. This was the single most important external factor in shaping the Agency's development. Of equal importance were the internal organizational arrangements that determined the patterns of influence within the Agency. In exploring the Agency's complex development, this summary will address the following questions: What institutional and jurisdictional obstacles prevented the Agency from fulfilling its original mission? To what extent have these obstacles persisted? In what ways have U.S. foreign policy objectives influenced priorities in the Agency's activities? What internal arrangements have determined the Agency's emphases in intelligence production and in clandestine

activities? What accounts for the continued dominance of the clandestine component within the Agency? How have individual Directors of Central Intelligence defined their roles and what impact have their definitions had on the direction of the Agency? What impact did technological developments have on the Agency and on the Agency's relationship with the departmental intelligence services?

This study is not intended to catalogue the CIA's covert operations but to present an analytical framework within which the CIA's policies and practices may be understood. The following section summarizes the Agency's evolution by dividing its history into four segments: 1946-1952; 1953-1961; 1962-1970; and 1971-1975. Each period constitutes a distinct phase in the Agency's development.

A. THE CENTRAL INTELLIGENCE GROUP AND THE CENTRAL INTELLIGENCE AGENCY: 1946-1952

The years 1946 to 1952 were perhaps the most crucial in determining the functions of the central intelligence organization. The period marked a dramatic transformation in the mission, size and structure of the new entity. In 1946 the Central Intelligence Group (CIG), the CIA's predecessor, was conceived and established as an intelligence coordinating body to minimize the duplicative efforts of the Departments and to provide objective intelligence analysis to senior policymakers. By 1952 the Central Intelligence Agency was engaged in independent intelligence production and covert operations. The CIG was an extension of Executive departments; its personnel and budget were allocated from State, Army and Navy. By 1952 the CIA had developed into an independent government agency commanding manpower and budget far exceeding anything originally imagined.

1. The Origins of the Central Intelligence Group

As World War II ended new patterns of decisionmaking emerged within the United States Government. In the transition from war to peace policymakers were redefining their organizational and informational needs. As President, Franklin Roosevelt maintained a highly personalized style of decisionmaking, relying primarily on informal conversations with senior officials. Truman preferred to confer with his cabinet officers as a collective body. This meant that officials in the State, War and Navy departments were more consistent participants in Presidential decisions than they had been under Roosevelt. From October through December 1945, U.S. Government agencies engaged in a series of policy debates about the necessity for and the nature of the future United States intelligence capability.

Three major factors dominated the discussions. The first was the issue of postwar reorganization of the Executive branch. The debate focussed around the question of an independent Air Force and the unification of the services under a Department of Defense. Discussion of a separate central intelligence agency and its structure, authority, and accountability was closely linked to the larger problem of defense reorganization.

Second, it was clear from the outset that no department was willing to consider resigning its existing intelligence function and accompany-

ing personnel and budgetary allotments to a central agency. As departmental representatives aired their preferences, maintenance of independent capabilities was an accepted element in defining future organization. Coordination, not centralization, was the maximum that each Department was willing to concede.

Third, the functions under discussion were intelligence analysis and the dissemination of intelligence. The shadow of the Pearl Harbor disaster dominated policymakers' thinking about the purpose of a central intelligence agency. They saw themselves rectifying the conditions that allowed Pearl Harbor to happen—a fragmented military-based intelligence apparatus which in current terminology could not distinguish "signals" from "noise," let alone make its assessments available to senior officials.

Formal discussion on the subject of the central intelligence function began in the fall of 1945. The Departments presented their separate views, while two independent studies also examined the issue. Inherent in all of the recommendations was the assumption that the Departments would control the intelligence product. None advocated giving a central independent group sole responsibility for collection and analysis. All favored making the central intelligence body responsible to the Departments themselves rather than to the President. Each Department lobbied for an arrangement that would give itself an advantage in intelligence coordination.

The Presidential directive establishing the Central Intelligence Group reflected these preferences. The Departments retained autonomy over their intelligence services, and the CIG's budget and staff were to be drawn from the separate agencies. Issued on January 22, 1946, the directive provided the CIG with a Director chosen by the President. The CIG was responsible for coordination, planning, evaluation, and dissemination of intelligence. The National Intelligence Authority (NIA), a group comprised of the Secretary of State, the Secretary of War, the Secretary of the Navy, and a personal representative of the President served as the Group's supervisory body. The Intelligence Advisory Board (IAB), which included the heads of the military and civilian intelligence agencies, was an advisory group to the Director of Central Intelligence (DCI).

Through budget, personnel, and oversight, the Departments had assured control over the Central Intelligence Group. The CIG was a creature of departments that were determined to maintain independent capabilities as well as their direct advisory relationship to the President. In January 1946 they succeeded in doing both; by retaining autonomy over their intelligence operations, they established the strong institutional claims that would persist for the lifetime of the Central Intelligence Agency.

2. The Directors of Central Intelligence, 1946-1952

At a time when the new agency was developing its mission, the role of its senior official was crucial. The Director of Central Intelligence was responsible for representing the agency's interests to the Departments and for pressing its jurisdictional claims. In large part the strength of the agency relative to the Departments was dependent on the stature that the DCI commanded as an individual. The four DCIs

from 1946 to 1952 ranged from providing only weak leadership to firmly solidifying the new organization in the Washington bureaucracy. Three of the four men were career military officers. Their appointments were indicative of the degree of control the military services managed to retain over the agency and the acceptance of the services' primary role in the intelligence process.

Sidney Souers, the first DCI, served from January to June 1946. Though a rear admiral, he was not a military careerist but a business executive, who had spent his wartime service in naval intelligence. He accepted the job with the understanding that he would remain only long enough to establish an organization. Having participated in the drafting of the directive which created CIG, Souers had a fixed concept of the central intelligence function—one that did not challenge the position of the departmental intelligence components.

Under Lieutenant General Hoyt Vandenberg, CIG moved beyond production of coordinated intelligence to acquire a clandestine collection capability as well as authority to conduct independent research and analysis. Vandenberg was an aggressive, ambitious personality, and as the nephew of Arthur Vandenberg, Chairman of the Senate Foreign Relations Committee, exerted considerable influence on behalf of the CIG. In May 1947, Vandenberg was succeeded by Rear Admiral Roscoe Hillenkoetter. Two months after Hillenkoetter's appointment, the CIG was reconstituted as the Central Intelligence Agency. Hillenkoetter did not command the personal stature to successfully assert the Agency's position relative to the Departments. Nor did he possess the administrative ability to manage the Agency's rapidly expanding functions.

It was precisely because of Hillenkoetter's weakness that General Walter Bedell Smith was selected to succeed him in October 1950. Nicknamed "the American Bulldog" by Winston Churchill, Smith was a tough-minded, hard-driving, often intimidating career military officer who effected major organizational changes during his tenure. Smith's temperament and his senior military status made him one of the strongest DCIs in the Agency's history. He left the Agency in February 1953.

3. The Evolution of the Central Intelligence Function, 1946-1952

The CIG had been established to rectify the duplication among the military intelligence services and to compensate for their biases. The rather vaguely conceived notion was that a small staff in the CIG would assemble and review the raw data collected by the departmental intelligence services and produce objective national estimates for the use of senior American policymakers. Although in theory the concept was reasonable and derived from informational needs, institutional resistance made implementation virtually impossible. The departmental services jealously guarded both their information and what they believed were their prerogatives in providing policy guidance to the President, making the CIG's primary mission an exercise in futility. Limited in the execution of its responsibility for coordinated estimates, the CIG emerged within a year as a current intelligence producer, generating its own summaries of daily events and thereby competing with the Departments in the dissemination of information.

An important factor in the change was the CIG's authorization to carry out independent research and analysis "not being presently performed" by the other Departments. Under this authorization, granted in the spring of 1946, the Office of Reports and Estimates (ORE) was established. ORE's functions were manifold—the production of national current intelligence, scientific, technical, and economic intelligence as well as interagency coordination for national estimates. With its own research and analysis capability, the CIG could carry out an independent intelligence function without having to rely on the departments for data. The change made the CIG an intelligence producer, while still assuming the continuation of its role as a coordinator for estimates.

Yet acquisition of a research and analysis role meant that independent production would outstrip coordinated intelligence as a primary mission. Fundamentally, it would be far easier to assimilate and analyze data than it had been or would be to engage the Departments in producing "coordinated" analysis.

The same 1946 directive which provided the CIG with an independent research and analysis capability also granted the CIG a clandestine collection capability. Since the end of the war, the remnant of OSS's clandestine collection capability rested with the Strategic Services Unit (SSU), then in the War Department. In the postwar dismantling of OSS, SSU was never intended to be more than a temporary body, and in the spring of 1946 SSU's duties, responsibilities and personnel were transferred to CIG along with SSU's seven overseas field stations and communications and logistical apparatus.

The transfer resulted in the establishment of the Office of Special Operations (OSO). OSO was responsible for espionage and counter-espionage. From the beginning the data collected by OSO was highly compartmented. ORE did not draw on OSO for its raw information. Instead, overt collection was ORE's major source of data.

Since its creation CIG had had two overt collection components. The Domestic Contact Service (DCS) solicited domestic sources, including travellers and businessmen for foreign intelligence information on a voluntary basis. The Foreign Broadcast Information Service (FBIS) an element of OSS, monitored overseas broadcasts. These components together with foreign publications provided ORE with most of its basic information.

The acquisition of a clandestine collection capability and authorization to carry out independent research and analysis enlarged CIG's personnel strength considerably. As of June 1946 the total CIG staff numbered approximately 1,816. Proportionately, approximately one-third were overseas with OSO. Of those stationed in Washington, approximately half were devoted to administrative and support functions, one-third were assigned to OSO, and the remainder to intelligence production.

The passage of the National Security Act in July 1947 legislated the changes in the Executive branch that had been under discussion since 1945. The Act established an independent Air Force, provided for coordination by a committee of service chiefs, the Joint Chiefs of Staff (JCS), and a Secretary of Defense, and created the National

Security Council (NSC). The CIG became an independent department and was renamed the Central Intelligence Agency.

Under the Act, the CIA's mission was only loosely defined, since efforts to thrash out the CIA's duties in specific terms would have contributed to the tension surrounding the unification of the services. The four general tasks assigned to the Agency were (1) to advise the NSC on matters related to national security; (2) to make recommendations to the NSC regarding the coordination of intelligence activities of the Departments; (3) to correlate and evaluate intelligence and provide for its appropriate dissemination and (4) "to perform such other functions . . . as the NSC will from time to time direct. . ."

The Act did not alter the functions of the CIG. Clandestine collection, overt collection, production of national current intelligence and interagency coordination for national estimates continued, and the personnel and internal structure remained the same.

The Act affirmed the CIA's role in coordinating the intelligence activities of the State Department and the military—determining which activities would most appropriately and most efficiently be conducted by which Departments to avoid duplication. In 1947 the Intelligence Advisory Committee (IAC) was created to serve as a coordinating body in establishing intelligence requirements² among the Departments. Chaired by the DCI, the Committee included representatives from the Departments of State, Army, Air Force, the Joint Chiefs of Staff, and the Atomic Energy Commission. Although the DCI was to establish priorities for intelligence collection and analysis, he did not have the budgetary or administrative authority to control the departmental components. Moreover, no Department was willing to compromise what it perceived as its own intelligence needs to meet the collective needs of policymakers as defined by the DCI.

As the CIA evolved between 1947 and 1950, it never fulfilled its estimates function but continued to expand its independent intelligence production. In July 1949 an internal study conducted by a senior ORE staff member stated that ORE's emphasis in production had shifted "from the broad long-term type of problem to a narrowly defined short-term type and from the predictive to the non-predictive type." In 1949 ORE had eleven regular publications. Only one of these addressed national intelligence questions and was published with the concurrence or dissent of the other departments. Less than one-tenth of ORE's products were serving the purpose for which the CIG and the CIA had been created.

4. The Reorganization of the Intelligence Function, 1950

By the time Walter Bedell Smith became DCI in 1950, it was clear that the CIA's record on the production of national intelligence estimates had fallen far short of expectation. ORE had become a directionless service organization, attempting to answer requirements levied by all agencies related to all manner of subjects—politics, economics, science, and technology. The wholesale growth had only confused ORE's mission and led the organization into attempting analysis in areas already adequately covered by other departments. Likewise, the

² Requirements constitute the informational objectives of intelligence collection, e.g., in 1947 determining Soviet troop strength in Eastern Europe.

obstacles posed by the Departments prevented the DCI and the Agency from carrying out coordination of the activities of the departmental intelligence components.

These problems appeared more stark following the outbreak of the Korean War in June 1950. Officials in the Executive branch and members of Congress criticized the Agency for its failure to predict more specifically the timing of the North Korean invasion of South Korea. Immediately after his appointment as DCI in October 1950, Smith discovered that the Agency had no current coordinated estimate of the situation in Korea. Under the pressure of war, demands for information were proliferating, and it was apparent that ORE could not meet those demands.

Smith embarked on a program of reorganization. His most significant change was the creation of the Office of National Estimates (ONE), whose sole purpose was to produce National Intelligence Estimates (NIEs). There were two components in ONE, a staff which drafted the estimates and a senior body, known as the Board of National Estimates, which reviewed the estimates, coordinated the judgments with other agencies, and negotiated over their final form.

Smith also attempted to redefine the DCI's position in relation to the departmental intelligence components. From 1947 to 1950 the DCIs had functioned at the mercy of the Departments rather than exercising direction over them. By formally stating his position as the senior member of the Intelligence Advisory Committee, Smith tried to assume a degree of administrative control over departmental activities. Nonetheless, the obstacles remained, and personal influence, rather than recognized authority, determined the effectiveness of Smith and his successors in interdepartmental relationships.

In January 1952, CIA's intelligence functions were grouped under the Directorate for Intelligence (DDI), ORE was dissolved and its personnel were reassigned. In addition to ONE, the DDI's intelligence production components included: the Office of Research and Reports (ORR), which handled economic and geographic intelligence; the Office of Scientific Intelligence (OSI), which engaged in basic scientific research; and the Office of Current Intelligence (OCI), which provided current political research. Collection of overt information was the responsibility of the Office of Operations (OO). The Office of Collection and Dissemination (OCD) engaged in the dissemination of intelligence as well as storage and retrieval of unevaluated intelligence.

The immediate pressures for information generated by the Korean War resulted in continued escalation in size and intelligence production. Government-wide demands for the Agency to provide information on Communist intentions in the Far East and around the world justified the increases. By the end of 1953 DDI personnel numbered 3,338. Despite the sweeping changes, the fundamental problem of duplication among the Agency and the Departments remained. DDI's major effort was independent intelligence production rather than coordinated national estimates.

v. Clandestine Operations

The concept of a central intelligence agency developed out of a concern for the quality of intelligence analysis available to policy-

makers. The 1945 discussion which surrounded the creation of the CIG focussed exclusively on the problem of production of coordinated intelligence judgments. Two years later, debates on the CIA in both the Congress and the Executive assumed only a collection and analysis role for the newly constituted Agency. Yet, within one year of the passage of the National Security Act, the CIA was charged with the conduct of covert psychological, political, paramilitary, and economic activities.³ The acquisition of this mission had a profound impact on the direction of the Agency and on its relative stature within the government.

The suggestion for the initiation of covert operations did not originate in the CIA, but with senior U.S. officials, among them Secretary of War James Patterson, Secretary of Defense James Forrestal, Secretary of State George Marshall, and George Kennan, Director of the State Department's Policy Planning Staff. Between 1946 and 1948 policymakers proceeded from a discussion of the possibility of initiating covert psychological operations to the establishment of an organization to conduct a full range of covert activities. The decisions were gradual but consistent, spurred on by the growing concern over Soviet intentions.

By late 1946 cabinet officials were preoccupied with the Soviet threat, and over the next year their fears intensified. For U.S. policymakers, international events seemed to be a sequence of Soviet incursions. In March 1946 the Soviet Union refused to withdraw its troops from the Iranian province of Azerbaijan; two months later civil war involving Communist rebel forces erupted in Greece. In 1947 Communists assumed power in Poland, Hungary and Rumania, and in the Philippines the government was under attack by the Hukbalahaps, a communist-led guerrilla group. In February 1948 Communists staged a successful coup in Czechoslovakia. At the same time France and Italy were beleaguered by a wave of Communist-inspired strikes. Policymakers could, and did, look at these developments as evidence of the need for the United States to respond.

In March 1948 near hysteria gripped the U.S. Government with the so-called "war scare." The crisis was precipitated by a cable from General Lucius Clay, Commander in Chief, European Command, to Lt. General Stephen J. Chamberlin, Director of Intelligence, Army General Staff, in which Clay said, "I have felt a subtle change in Soviet attitude which I cannot define but which now gives me a feeling that it [war] may come with dramatic suddenness." The war scare launched a series of interdepartmental intelligence estimates on the likelihood of a Soviet attack on Western Europe and the United States. Although the estimates concluded that there was no evidence the U.S.S.R. would start a war, Clay's cable had articulated the degree of suspicion and outright fear of the Soviet Union that was shared by policymakers in 1948.

For U.S. officials, the perception of the Soviet Union as a global threat demanded new modes of conduct in foreign policy to supple-

³ Psychological operations were primarily media-related activities, including unattributed publications, forgeries, and subsidization of publications; political action involved exploitation of dispossessed persons and defectors, and support to political parties; paramilitary activities included support to guerrillas and sabotage; economic activities consisted of monetary and fiscal operations.

ment the traditional alternatives of diplomacy and war. Massive economic aid represented one new method of achieving U.S. foreign policy objectives. In 1947 the United States had embarked on an unprecedented economic assistance program to Europe with the Truman Doctrine and the Marshall Plan. By insuring economic stability, U.S. officials hoped to limit Soviet encroachments. Covert operations represented another, more activist departure in the conduct of U.S. peacetime foreign policy. Covert action was an option that was something more than diplomacy but still short of war. As such, it held the promise of frustrating Soviet ambitions without provoking open conflict.

The organizational arrangements for the conduct of covert operations reflected both the concept of covert action as defined by U.S. officials and the perception of the CIA as an institution. Both the activities and the institution were regarded as extensions of the State Department and the military services. Covert action was to serve a support function to foreign and military policy preferences, and the CIA was to provide the vehicle for the execution of those preferences.

In June 1948, a CIA component, the Office of Special Projects, soon renamed the Office of Policy Coordination (OPC), was established for the execution of covert operations. The specific activities included psychological warfare, political warfare, economic warfare, and paramilitary activities. OPC's budget and personnel were appropriated within CIA allocations, but the DCI had no authority in determining OPC's activities. Responsibility for the direction of OPC rested with the Office's director, appointed by the Secretary of State. Policy guidance—decisions on the need for specific activities—came to the OPC director from State and Defense, bypassing the DCI.

In recommending the development of a covert action capability in 1948, policymakers intended to make available a small contingency force with appropriate funding that could mount operations on a limited basis. Senior officials did not plan to develop large-scale continuing activities. Instead, they hoped to establish a small capability that could be activated when and where the need occurred—at their discretion.

6. *The Office of Policy Coordination, 1948-1952*

OPC developed into a far different organization from that envisioned by Forrestal, Marshall, and Kennan. By 1952, when it merged with the Agency's clandestine collection component, the Office of Special Operations, OPC had innumerable activities worldwide, and it had achieved the institutional independence that was unimaginable at the time of its inception.

The outbreak of the Korean War in the summer of 1950 had a significant effect on OPC. Following the North Korean invasion of South Korea, the State Department as well as the Joint Chiefs of Staff requested the initiation of paramilitary activities in Korea and China. OPC's participation in the war effort contributed to its transformation from an organization that was to provide the capability for a limited number of *ad hoc* operations to an organization that conducted continuing, ongoing activities on a massive scale. In concept, manpower, budget, and scope of activities, OPC simply skyrocketed. The comparative figures for 1949 and 1952 are staggering. In 1949 OPC's

total personnel strength was 302; in 1952 it was 2,812 plus 3,142 overseas contract personnel. In 1949 OPC's budget figure was \$4,700,000; in 1952 it was \$82,000,000. In 1949 OPC had personnel assigned to seven overseas stations; in 1952 OPC had personnel at forty-seven stations.⁴

Apart from the impetus provided by the Korean War several other factors converged to alter the nature and scale of OPC's activities. First, policy direction took the form of condoning and fostering activity without providing scrutiny and control. Officials throughout the government regarded the Soviet Union as an aggressive force, and OPC's activities were initiated and justified on the basis of this shared perception. The series of NSC directives which authorized covert operations laid out broad objectives and stated in bold terms the necessity for meeting the Soviet challenge head on. After the first 1948 directive authorizing covert action, subsequent directives in 1950 and 1951 called for an intensification of these activities without establishing firm guidelines for approval. State and Defense guidance to OPC quickly became very general, couched in terms of overall goals rather than specific activities. This allowed OPC maximum latitude for the initiation of activities or "projects," the OPC term.

Second, OPC operations had to meet the very different policy needs of the State and Defense Departments. The State Department encouraged political action and propaganda activities to support its diplomatic objectives, while the Defense Department requested paramilitary activities to support the Korean War effort and to counter Communist-associated guerrillas. These distinct missions required OPC to develop and maintain different capabilities, including manpower and support material.

The third factor contributing to OPC's expansion was the organizational arrangements that created an internal demand for projects. To correlate the requirements of State and Defense with its operations, OPC adopted a project system rather than a programmed financial system. This meant that OPC activities were organized around projects rather than general programs or policy objectives and that OPC budgeted in terms of anticipated numbers of projects. The project system had important internal effects. An individual within OPC judged his own performance, and was judged by others, on the importance and number of projects he initiated and managed. The result was competition among individuals and among the OPC divisions to generate the maximum number of projects. Projects remained the fundamental units around which covert activities were organized, and two generations of Agency personnel have been conditioned by this system.

7. OPC Integration and the OPC-OSO Merger

The creation of OPC and its ambiguous relationship to the Agency precipitated two major administrative problems: the DCI's relationship to OPC, and antagonism between OPC and the Agency's clandestine collection component, the Office of Special Operations. DCI Walter Bedell Smith acted to rectify both problems.

⁴ Congress in 1949 enacted legislation exempting the DCI from the necessity of accounting for specific disbursements.

As OPC continued to grow, Smith's predecessor, Admiral Hillenkoetter, resented the fact that he had no management authority over OPC, although its budget and personnel were being allocated through the CIA. Hillenkoetter's clashes with the State and Defense Departments as well as with Frank G. Wisner, the Director of OPC, were frequent. Less than a week after taking office, Smith announced that as DCI he would assume administrative control of OPC and that State and Defense would channel their policy guidance through him rather than through Wisner. On October 12, 1950, the representatives of State, Defense and the Joint Chiefs of Staff formally accepted the change. The ease with which the shift occurred was primarily a result of Smith's own position of influence with the Departments.

OPC's anomalous position in the Agency revealed the difficulty of maintaining two separate organizations for the execution of varying but overlapping clandestine activities. The close "tradercraft" relationship between clandestine collection and covert action, and the frequent necessity for one to support the other was totally distorted with the separation of functions in OSO and OPC. Organizational rivalry rather than interchange dominated the relationship between the two components.

On the operating level the conflicts were vicious. Each component had representatives conducting separate operations at each overseas station. Given the related missions of the two, OPC and OSO personnel were often competing for the same agents and, not infrequently, attempting to wrest agents from each other. In 1952 the outright hostility between the two organizations in Bangkok required the direct intervention of the Assistant Director for Special Operations, Lyman Kirkpatrick. There an important local official was closely tied to OPC, and OSO was trying to lure him into its employ.

Between 1950 and 1952 Smith took several interim steps to encourage coordination between the two components. In August 1952 OSO and OPC were merged into the Directorate for Plans (DDP). The lines between the OSO "collectors" and the OPC "operators" blurred rapidly, particularly in the field, where individuals were called upon to perform both functions.

The merger did not result in the dominance of one group over another; it resulted in the maximum development of clandestine operations over clandestine collection. For people in the field, rewards came more quickly through visible operational accomplishments than through the silent, long-term development of agents required for clandestine collection. In the words of one former high-ranking DDP official, "Collection is the hardest thing of all; it's much easier to plant an article in a local newspaper."

To consolidate the management functions required for the burgeoning organization, Smith created the Directorate for Administration (DDA). From the outset, much of the DDA's effort supported field activities. The Directorate was responsible for personnel, budget, security, and medical services Agency-wide. However, one quarter of DDA's total personnel strength was assigned to logistical support for overseas operations.

By 1953 the Agency had achieved the basic structure and scale it retained for the next twenty years. The Korean War, United States foreign policy objectives, and the Agency's internal organizational arrangements had combined to produce an enormous impetus for growth. The CIA was six times the size it had been in 1947.

Three Directorates had been established. The patterns of activity within each Directorate and the Directorates' relationships to one another had developed. The DDP commanded the major share of the Agency's budget, personnel, and resources; in 1952 clandestine collection and covert action accounted for 74 percent of the Agency's total budget;⁸ its personnel constituted 60 percent of the CIA's personnel strength. While production rather than coordination dominated the DDI, operational activities rather than collection dominated the DDP. The DDI and the DDP emerged at different times out of disparate policy needs. They were, in effect, separate organizations. These fundamental distinctions and emphases were reinforced in the next decade.

B. THE DULLES ERA: 1953-1961

Allen W. Dulles' impact on the Central Intelligence Agency was perhaps greater than that of any other single individual. The source of his influence extended well beyond his personal qualities and inclinations. The composition of the United States Government, international events, and senior policymakers' perception of the role the Agency could play in United States foreign policy converged to make Dulles' position and that of the Agency unique in the years 1953 to 1961.

The election of 1952 brought Dwight D. Eisenhower to the presidency. Eisenhower had been elected on a strident anti-Communist platform, advocating an aggressive worldwide stance against the Soviet Union to replace what he described as the Truman Administration's passive policy of containment. Eisenhower cited the Communist victory in China, the Soviet occupation of Eastern Europe, and the Korean War as evidence of the passivity which had prevailed in the United States Government following World War II. He was equally passionate in his call for an elimination of government corruption and for removal of Communist sympathizers from public office.

This was not simply election rhetoric. The extent to which the urgency of the Communist threat had become a shared perception is difficult to appreciate. By the close of the Korean War, a broad consensus had developed about the nature of Soviet ambitions and the need for the United States to respond. The earlier fear of United States policymakers that the Soviet Union would provoke World War III had subsided. Gradually, the Soviet Union was perceived as posing a worldwide political threat. In the minds of government officials, members of the press, and the informed public, the Soviets would try to achieve their purposes by the penetration and subversion of governments all over the world. The accepted role of the United States was to prevent that expansion.

⁸ This did not include DDA budgetary allocations in support of DDP operations.

Washington policymakers regarded the Central Intelligence Agency as a primary means of defense against Communism. By 1953, the Agency was an established element of government. Its contributions in the areas of political action and paramilitary warfare were recognized and respected. It alone could perform many of the kinds of activities seemingly required to meet the Soviet threat. For senior officials, covert operations had become a vital element in the pursuit of United States foreign policy objectives.

At this time, the CIA attracted some of the most able lawyers, academicians, and young, committed activists in the country. They brought with them professional associations and friendships which extended to the senior levels of government. The fact that Agency employees often shared similar wartime experiences, comparable social backgrounds, and then complementary positions with other government officials, contributed significantly to the legitimacy of and confidence in the Agency as an instrument of government. Moreover, these informal ties created a tacit understanding among policymakers about the role and direction of the Agency. At the working level, these contacts were facilitated by the Agency's location in downtown Washington. Housed in a sprawling set of buildings in the center of the city, Agency personnel could easily meet and talk with State and Defense officials throughout the day. The CIA's physical presence in the city gave it the advantage of seeming an integral part of, rather than a separate element of, the government.

A crucial factor in securing the Agency's place within the government during this period was the fact that the Secretary of State, John Foster Dulles, and the DCI were brothers. Whatever the formal relationships among the State Department, the NSC, and the Agency, they were superseded by the personal and working association between the brothers. Most importantly, both had the absolute confidence of President Eisenhower. In the day-to-day formulation of policy, these relationships were crucial to the Executive's support for the Agency, and more specifically, for Allen Dulles personally in the definition of his own role and that of the Agency.

No one was more convinced that the Agency could make a special contribution to the advancement of United States foreign policy goals than Allen Dulles. Dulles came to the post of DCI in February 1953 with an extensive background in foreign affairs and foreign espionage, dating back to World War I. By the time of his appointment, his view of the CIA had been firmly established. Dulles' role as DCI was rooted in his wartime experience with OSS. His interests and expertise lay with the operational aspects of intelligence, and his fascination with the details of operations persisted.

Perhaps the most important effect of Dulles' absorption with operations was the impact it had on the Agency's relationship to the intelligence "community"—the intelligence components in State and Defense. As DCI Dulles did not assert his position or that of the Agency in attempting to coordinate departmental intelligence activities.

This, after all, had been a major purpose for the Agency's creation. Dulles' failure in this area constituted a lost opportunity. By the mid-

dle of the decade the Agency was in the forefront of technological innovation and had developed a strong record on military estimates. Conceivably, Dulles could have used these advances as bureaucratic leverage in exerting some control over the community. He did not. Much of the reason was a matter of personal temperament. Jolly, gregarious, and extroverted in the extreme, Dulles disliked and avoided confrontations at every level. In doing so, he failed to provide even minimal direction over the departmental intelligence components at a time when intelligence capabilities were undergoing dramatic changes.

1. *The Clandestine Service*^{5a}

It is both easy to exaggerate and difficult to appreciate the place which the Clandestine Service secured in the CIA during the Dulles administration and, to a large extent, retained thereafter. The number and extent of the activities undertaken are far less important than the impact which those activities had on the Agency's institutional identity—the way people within the DDP, the DDI, and the DDA perceived the Agency's primary mission, and the way policymakers regarded its contribution to the process of government.

Covert action was at the core of this perception. The importance of covert action to the internal and external evaluation of the Agency was in large part derived from the fact that only the CIA could and did perform this function. Moreover, in the international environment of the 1950's Agency operations were regarded as an essential contribution to the attainment of United States foreign policy objectives. Although by 1954 the Soviet threat was redefined from military to political terms, the intensity of the conflict did not diminish. Political action, sabotage, support to democratic governments, counterintelligence—all this the Clandestine Service could provide.

The Agency also benefited from what were regarded as its operational "successes" in this period. In 1953 and 1954 two of the Agency's boldest, most spectacular covert operations took place—the overthrow of Premier Mohammed Mossadegh in Iran and the coup against President Jacobo Arbenz Guzman of Guatemala. Both were quick and bloodless operations that removed two allegedly Communist-associated leaders from power and replaced them with pro-Western officials. Out of these early achievements both the Agency and Washington policymakers acquired a sense of confidence in the CIA's capacity for operational success.

The DDP's major expansion in overseas stations and in the establishment of an infrastructure for clandestine activities had taken place between 1950 and 1952. In the decade of the 1950's the existing structure made possible the development of continuous foreign intelligence, counterintelligence, political action, and propaganda activities.

Policymakers' perception of covert action as the CIA's primary mission was an accurate reflection of the Agency's internal dynamics. Between 1953 and 1962, the Clandestine Service occupied a preeminent position in the CIA. First, it had the consistent attention of the DCI.

^{5a} The term "Clandestine Service" is used synonymously with the Deputy Directorate for Plans. Although Clandestine Service has never been an official designation, it is common usage in the Intelligence community and appears as such in the Select Committee's hearings.

Second, the DDP commanded the major portion of resources in the Agency. Between 1953 and 1961 clandestine collection and covert action absorbed an average of 54 percent of the Agency's total annual budget.⁶ Although this represented a reduction from the period of the Korean War, DDP allocations still constituted the majority of the Agency's expenditures. Likewise, from 1953 to 1961, the DDP gained nearly 2,000 personnel. On its formal table of organization, the DDP registered an increase of only 1,000. However, increases of nearly 1,000 in the logistics and communications components of the DDA represented growth in support to Clandestine Service operations.

Within the Agency the DDP was a Directorate apart. As the number of covert action projects increased, elaborate requirements for secrecy developed around operational activities. The DDP's self-imposed security requirements left it exempt from many of the Agency's procedures of accountability. Internally, the DDP became a highly compartmented structure, where information was limited to small groups of individuals based primarily on a "need to know" principle.

The norms and position of the Clandestine Service had important repercussions on the execution of the CIA's intelligence mission in the 1953 to 1962 period. Theoretically, the data collected by the DDP field officers should have served as a major source for DDI analysis. However, strict compartmentation prevented open contact between DDP personnel and DDI analysts. Despite efforts in the 1960's to break down the barriers between the Directorates, the lack of real interchange and interdependence persisted.

In sum, the DDP's preeminent position during the period was a function of several factors, including policymakers' perception of the Agency primarily in operational terms, the proportion of resources which the Clandestine Service absorbed, and the time and attention which the DCI devoted to operations. These patterns solidified under Dulles and in large part account for the DDP's continued primacy within the Agency.

2. Intelligence Production

In the decade of the 1950's the CIA was the major contributor to technological advances in intelligence collection. At the same time DDI analysts were responsible for methodological innovations in strategic assessments. Despite these achievements, CIA's intelligence was not serving the purpose for which the organization had been created—informing and influencing policymaking.

By 1960 the Agency had achieved significant advances in its strategic intelligence capability. The development of overhead reconnaissance, beginning with the U-2 aircraft and growing in scale and sophistication with follow-on systems, generated information in greater quantity and accuracy than had ever before been contemplated. Basic data on the Soviet Union beyond the reach of human collection, such as railroad routes, construction sites, and industrial concentrations became readily available.

Analysts in the Office of National Estimates began reevaluating assumptions regarding Soviet strategic capabilities. This reevaluation resulted in reduced estimates of Soviet missile deployments at a time when the armed services and members of Congress were publicly

⁶ This did not include DDA budgetary allocations in support of DDP operations.

proclaiming a "missile gap" between the United States and the Soviet Union.

A final element contributed to the Agency's estimative capability: material supplied by Oleg Penkovsky. Well-placed in Soviet military circles, Penkovsky turned over a number of classified documents relating to Soviet strategic planning and capabilities. These three factors—technological breakthrough, analytic innovation, and the single most valuable Soviet agent in history—converged to make the Agency the most reliable source of intelligence on Soviet strategic capabilities in the government.

Yet the entrenched position of the military services and the Agency's own limited charter in the area of military analysis made it difficult for the Agency to challenge openly the intelligence estimates of the services. The situation was exacerbated by Dulles' own disposition. As DCI he did not associate himself in the first instance with intelligence production and did not assume an advocacy role in extending the Agency's claims to military intelligence.

Strategic intelligence, although a significant portion of the DDI's production effort, constituted a particular problem. A broader problem involved the overall impact of intelligence on policy. The CIA had been conceived to provide high-quality national intelligence estimates to policymakers. However, the communication and exchange necessary for analysts to calibrate, anticipate and respond to policymakers' needs never really developed.

The size of the Directorate for Intelligence constituted a major obstacle to the attainment of consistent interchange between analysts and their clients. In 1955 there were 466 analysts in ORR, 217 in OCI, and 207 in OSI. The process of drafting, reviewing and editing intelligence publications involved large numbers of individuals each of whom felt responsible for and entitled to make a contribution to the final product. Yet without access to policymakers, analysts did not have an ongoing accurate notion of how the form and substance of the intelligence product might best serve the needs of senior officials. The product itself—as defined and arbitrated among DDI analysts—became the end rather than the satisfaction of specific policy needs.

The establishment of the Office of National Estimates was an attempt to insure direct interaction between senior level officials and the Agency. However, by the mid-1950's even its National Intelligence Estimates showed signs of being submerged in the second-level paper traffic that was engulfing the intelligence community. Between 1955 and 1956 a senior staff member in ONE surveyed the NIEs' readership by contacting executive assistants and special assistants of the President and cabinet officers, asking if the NIEs were actually placed on their superiors' desks. The survey revealed that senior policymakers were not reading the NIEs. Instead, second and third-level officials used the estimates for background information in briefing senior officials. The failure of the NIEs to serve their fundamental purpose for senior officials was indicative of the overall failure of intelligence to influence policy.

3. The Community Coordination Problem

Dulles' neglect of the community management or coordination aspect of his role as DCI was apparent to all who knew and worked with

him. His reluctance to assume an aggressive role in dealing with the military on the issue of military estimates was closely tied to his lack of initiative in community-related matters. Unlike Bedell Smith before him and John McCone after him, Dulles was reluctant to take on the military.

The development of the U-2 and follow-on systems had an enormous impact on intelligence-collection capabilities and on the Agency's relative standing in the intelligence community. Specifically, it marked the Agency's emergence as the intelligence community's leader in the area of overhead reconnaissance.

At a time when the CIA was reaping the benefits of overhead reconnaissance and when the DDI's estimates on Soviet missiles were taking issue with the services' judgments, Dulles could have been far more aggressive in asserting the Agency's position in the intelligence community and in advancing his own role as coordinator.

As the community became larger and as technical systems came to require very large budgetary allocations, the institutional obstacles to interdepartmental coordination increased. By not acting on the opportunity he had, Dulles allowed departmental procedures, specifically those in the military's technical collection programs, to become more entrenched and routinized, making later attempts at coordination more difficult.

The coordination problem did not go unnoticed during Dulles' term, and there were several attempts within Congress and the Executive to direct Dulles' attention to the DCI's community responsibility. The efforts were unsuccessful both because of Dulles' personal disposition and because of the inherent weakness of the mechanisms established to strengthen the DCI's position in the community.

In January 1956, President Eisenhower created the President's Board of Consultants on Foreign Intelligence Activities (PBCFIA). In May, 1961 it was renamed the President's Foreign Intelligence Advisory Board (PFIAB). Composed of retired senior government officials and members of the professions, the Board was to provide the President with advice on intelligence matters. As a deliberative body it had no authority over either the DCI or the community. Thus, the Board had little impact on the administration of the CIA or on the other intelligence services. The Board did identify the imbalance in Dulles' role as DCI, and in December 1956 and again in December 1958 it recommended the appointment of a chief of staff for the DCI to handle the Agency's internal administration. In 1960, the PBCFIA suggested the possibility of separating the DCI from the Agency to serve as the President's intelligence advisor and to coordinate community activities. Nothing resulted from these recommendations.

In 1957, the Board recommended the merger of the United States Communications Intelligence Board with the Intelligence Advisory Committee.¹ This proposal was intended to strengthen the DCI's

¹ The USCIB was established in 1946 to advise and make recommendations on communications intelligence to the Secretary of Defense. USCIB's membership included the Secretaries of State, Defense, the Director of the FBI, and representatives of the Army, Navy, Air Force, and CIA. USCIB votes were weighted. Representatives of State, Defense, the FBI, and CIA each had two votes; other members had one. Although the DCI sat on the Committee, he had no vote.

authority, and it resulted in the creation in the following year of the United States Intelligence Board (USIB) with the DCI as chairman.

Like the IAC, however, USIB was little more than a super-structure. It had no budgetary authority; nor did it provide the DCI with any direct control over the components of the intelligence community. The separate elements of the community continued to function under the impetus of their own internal drives and mission definitions. Essentially, the problem that existed at the time of the creation of the CIG remained.

From 1953 to 1961 a single Presidential administration and consistent American policy objectives which had wide public and governmental support contributed to a period of stability in the Agency's history. The internal patterns that had begun to emerge at the close of the Korean War solidified. The problems remained much the same.

The inherent institutional obstacles to management of the community's intelligence activities combined with Dulles' failure to assert the Agency's and the DCI's coordination roles allowed the perpetuation of a fragmented government-wide intelligence effort. The CIA's own intelligence production, though distinguished by advances in technical collection and in analysis, had not achieved the consistent policy support role that the Agency's creation had intended to provide.

Dulles' marked orientation toward clandestine activities, his brother's position as Secretary of State, and cold war tensions combined to maximize the Agency's operational capability. In terms of policymakers' reliance on the CIA, allocation of resources, and the attention of the Agency's leadership, clandestine activities had overtaken intelligence analysis as the CIA's primary mission.

C. CHANGE AND ROUTINIZATION: 1961-1970

In 1961 cold war attitudes continued to dominate the foreign policy assumptions of United States policymakers. In the early part of the decade American confidence and conviction were manifested in an expansive foreign policy that included the abortive Bay of Pigs landing, a dramatic confrontation with the Soviet Union over the installation of Soviet missiles in Cuba, increased economic assistance to underdeveloped countries in Latin America and Africa, and rapidly escalating military activities in Southeast Asia.

Although the American presence in Vietnam symbolized U.S. adherence to the strictures of the Cold War, perceptions of the Soviet Union began to change by the middle of the decade. The concept of an international monolith broke down as differences between the U.S.S.R. and China emerged. Moreover, the strategic arms competition assumed increased importance in relations between the two countries.

The CIA was drawn into each major development in United States policy. As in the previous decade, operations dominated policymakers' perceptions of the Agency's role. The United States' interventionist policy fostered the CIA's utilization of its existing capabilities as well as the development of paramilitary capabilities in support of American counterinsurgency and military programs. At the same time the Agency's organizational arrangements continued to create an independent dynamic for operations.

The most significant development for the Agency in this period was the impact of technological capabilities on intelligence production. These advances resulted in internal changes and forced increased attention to coordination of the intelligence community. The costs, quality of intelligence and competition for deployment generated by technical collection systems necessitated a working relationship among the departmental intelligence components to replace the undirected evolution that had marked the previous decade. Despite the Agency's internal adjustments and attempts to effect better management in the community, the CIA's fundamental structure, personnel, and incentives remained rooted in the early 1950's.

1. The Directors of Central Intelligence, 1961-1970

John A. McCone came to the Central Intelligence Agency as an outsider in November 1961. His background had been in private industry, where he had distinguished himself as a corporate manager. He also held several government posts, including Under Secretary of the Air Force and Chairman of the Atomic Energy Commission. McCone brought a quick, sharp intellect to his job as DCI, and his contribution lay in attempting to assert his role and that of the Agency in coordinating intelligence activities among the Departments. Much of his strength in the intelligence community derived from the fact that he was known to have ready access to President Kennedy. McCone resigned from the Agency in April 1965, precisely because Lyndon Johnson had not accorded him similar stature.

Admiral William F. Raborn served as DCI for only a year. He left in June 1966, and his impact on the Agency was minimal.

Richard M. Helms came to the position of DCI after twenty years in the Clandestine Service. Just as Allen Dulles had identified himself with the intelligence profession, Helms identified himself with the Agency as an institution. Having served in a succession of senior positions, Helms was a first-generation product of the Agency, and he commanded the personal and professional respect of his contemporaries. Helms' orientation remained on the operations side, and he did not actively pursue the DCI's role as a coordinator of intelligence activities in the community.

2. The Effort at Management Reform

The Bay of Pigs fiasco had a major impact on President Kennedy's thinking about the intelligence community. He felt he had been poorly served by the experts and sought to establish procedures that would better insure his own acquisition of intelligence. In short, Kennedy defined a need for a senior intelligence officer and in so doing assured John McCone an influential position in policymaking. Kennedy's definition of the DCI's position emphasized two roles: coordinator for the community, and principal intelligence adviser to the President. At the same time, Kennedy directed McCone to delegate the internal management of the Agency to a deputy director. Although McCone agreed with Kennedy's concept of the DCI's job and vigorously pursued the objectives, the results were uneven.

To carry out the management function in the Agency, McCone created a senior staff. The principal officer was the Executive Director-Comptroller, who was to assume responsibility for day-to-day ad-

ministration.⁸ The arrangement did not free the DCI from continuing involvement in Agency-related matters, particularly those concerning the Clandestine Service. The nature of clandestine operations, the fact that they involved and continue to involve people in sensitive, complicated situations, demanded that the Agency's senior officer assume responsibility for decisions. A former member of McCone's staff estimates that despite the DCI's community orientation, he spent 90 percent of his total time on issues related to clandestine operations.

The establishment of the office of National Intelligence Programs Evaluation (NIPE) in 1963 was the first major effort by a DCI to insure consistent contact and coordination with the community. Yet, from the outset McCone accepted the limitations on his authority; although Secretary of Defense Robert McNamara agreed to provide him with access to the Defense Department budget (which still constitutes 80 percent of the intelligence community's overall budget), McCone could not direct or control the intelligence components of the other departments. The NIPE staff directed most of its attention to sorting out intelligence requirements through USIB and attempting to develop a national inventory for the community, including budget, personnel and materials. Remarkably, this had never before been done.

The most pressing problem for the community was the adjustment to the impact of technical collection capabilities. The large budgetary resources involved, and the value of the data generated by overhead reconnaissance systems precipitated a major bureaucratic battle over their administration and control. From 1963 to 1965, much of McCone's and the senior NIPE staff officer's community efforts were directed toward working out an agreement with the Air Force on development, production, and deployment of overhead reconnaissance systems.

In 1961 the Agency and the Air Force had established a working relationship for overhead reconnaissance systems through a central administrative office, whose director reported to the Secretary of Defense but accepted intelligence requirements through USIB. By informal agreement, the Air Force provided launchers, bases, and recovery capability for reconnaissance systems, while the Agency was responsible for research, development, contracting, and security. Essentially, the agreement allowed the Agency to decide which systems would be deployed, and the Air Force challenged the CIA's jurisdiction.

A primary mission was at stake in these negotiations, and the struggle was fierce on both sides. Control by one agency or another did not involve only budgets and manpower. Since the Air Force and CIA missions were very different, a decision would affect the nature of the reconnaissance program itself—tactical or national intelligence priorities, the frequency and location of overflights, and the use of data.

The agreement that emerged in 1965 attempted to balance the interests of both the Air Force and the CIA. A three-person Executive Committee (EXCOM) for the administration of overhead reconnaissance was established. Its members included the DCI, an Assistant Secretary of Defense, and the President's Scientific Advisor. The EXCOM reported to the Secretary of Defense, who was assigned primary administrative authority for overhead reconnaissance systems. The

⁸ Other changes included placing the General Counsel's office, the Audit Staff, and the Office of Budget, Program Analysis and Manpower directly under the DCI.

arrangement recognized the DCI's authority as head of the community to establish collection requirements in consultation with USIB; it also gave him responsibility for processing and utilizing data generated by overhead reconnaissance. In the event that he did not agree with a decision made by the Secretary of Defense, the DCI was given the right to appeal to the President.

The agreement represented a compromise between Air Force and CIA claims and provided substantive recognition of the DCI's national intelligence responsibility. As a structure for decisionmaking, it has worked well. However, it has not rectified the inherent competition over technical collection systems that has come to motivate the intelligence process. The development of these systems has created intense rivalry, principally between the Air Force and the Agency, over program deployments. With so much money and manpower at stake with each new system, each organization is eager to gain the benefits of successful contracting. As a result, the accepted solution to problems with the intelligence product has come to be more collection rather than better analysis.

After 1965 efforts to impose some direction on the community did not receive consistent attention from DCIs Raborn and Helms. The DCIs' priorities, coupled with the inherent bureaucratic obstacles and the burden of Vietnam, relegated the problem of coordination to a low priority.

3. The Intelligence Function

Internally, the Agency was also adjusting to the impact of technical and scientific advances. In 1963, the Directorate for Science and Technology (DDS&T) was created. Previously, scientific and technical intelligence production had been scattered among the other three directorates. The process of organizing an independent directorate meant wresting manpower and resources from the existing components. Predictably, the resistance was considerable, and a year and a half passed between the first attempts at creating the Directorate and its actual establishment.

The new component included the Office of Scientific Intelligence and the office of ELINT (electronic intercepts) from DDI, the Data Processing Staff from DDA, the Development Projects Division (responsible for overhead reconnaissance) from the DDP, and a newly created Office of Research and Development. Later in 1963, the Foreign Missile and Space Analysis Center was added. The Directorate's specific functions included, and continue to include, research, development, operation, data reduction, analysis, and contributions to National Intelligence Estimates.

The Directorate was organized on the premise that close cooperation should exist between research and application on the one hand, and technical collection and analysis on the other. This close coordination along with the staffing and career patterns in the Directorate have contributed to the continuing vitality and quality of the DDS&T's work.

The DDP began and remained a closed, self-contained component; the DDI evolved into a closed, self-contained component. However, the DDS&T was created with the assumption that it would continue to rely on expertise and advice from outside the Agency. A number of

arrangements insured constant interchanges between the Directorate and the scientific and industrial communities. First, since all research and development for technical systems was done through contracting, the DDS&T could draw on and benefit from the most advanced technical systems nationwide. Second, to attract high-quality professionals from the industrial and scientific communities, the Directorate established a competitive salary scale. The result has been personnel mobility between the DDS&T and private industry. It has not been unusual for individuals to leave private industry, assume positions with DDS&T for several years, then return to private industry. This pattern has provided the Directorate with a constant infusion and renewal of talent. Finally, the Directorate established the practice of regularly employing advisory groups as well as fostering DDS&T staff participation in conferences and seminars sponsored by professional associations.

The Agency's intelligence capabilities expanded in another direction. Although in the 1953-1961 period, the Agency had made some contributions to military intelligence, it had not openly challenged the Defense Department's prerogative in this area. In the early 1960's that opportunity came. By 1962, Secretary of Defense Robert McNamara's dissatisfaction with the quality of military estimates led him to begin tapping the Agency's analytic capabilities. Specifically, McNamara requested special estimates from the Agency and included Agency personnel in community-wide exercises in long-term Soviet force projections. McNamara's initiatives provided the CIA with leverage against the military services' dominance in strategic intelligence. The Secretary's actions, together with McCone's insistence on the DCI's need for independent judgments on military matters, resulted in the Agency's expanded analytic effort in strategic intelligence.

In 1962, the Office of Current Intelligence established a military intelligence division, and five years later the military intelligence units of OCI and ORR were combined into a separate office, the Office of Strategic Research (OSR).

During this period economic intelligence grew in importance. In the decade of the 1950's economic research had concentrated on analysis related to the Soviet Union and its "satellites." With the emergence of independent African nations in the early 1960's, and the view that the U.S.S.R. would engage in political and economic penetration of the fledgling governments, demands for information on the economies of these countries developed. Likewise, the growing economic strength of Japan and the countries of Western Europe produced a related decline in the U.S. competitive posture and reflected the growing inadequacy of the dollar-dominated international monetary system. Economic analysts found themselves called upon for detailed research on these countries as trading partners and rivals of the United States. In 1967 an independent Office of Economic Research (OER) succeeded ORR.

4. The Paramilitary Surge

The Clandestine Service continued to dominate the Agency's activities during this period. In budget, manpower, and degree of DCI attention accorded the DDP, clandestine operations remained the CIA's most consuming mission. The policies and operational prefer-

ences of the Executive branch dictated the Agency's emphasis in clandestine activities.

Evidence of Communist guerrilla activities in Southeast Asia and Africa convinced Kennedy and his closest advisers of the need for the United States to develop an unconventional warfare capability. "Counterinsurgency," as the U. S. effort was designated, aimed at preventing communist-supported military victories without precipitating a major Soviet-American military confrontation.

As part of this effort, the Agency, under the direction of the Kennedy Administration, initiated paramilitary operations in Cuba, Laos, and Vietnam. Following the Bay of Pigs, attempts to undermine the government of Cuban Premier Fidel Castro continued with Operation MONGOOSE. Conducted between October 1961 and October 1962, MONGOOSE consisted of paramilitary, sabotage, and political propaganda activities. The Agency's large-scale involvement in Southeast Asia began in 1962 with programs in Laos and South Vietnam. In Laos, the Agency implemented air supply and paramilitary training programs, which gradually developed into full-scale management of a ground war. Between 1962 and 1965, the Agency worked with the South Vietnamese government to organize police forces and paramilitary units.

In the remainder of the decade, Vietnam dominated the CIA just as it did other government agencies. In both the DDP and the DDI, the CIA's resources were directed toward supporting and evaluating the U.S. effort in Vietnam. For the Agency and the DCI, it was a contradictory position, one which left the institution and the man vulnerable to the pressures of conflicting purposes.

On the one hand, the DDP was supporting a major paramilitary operation, which, at its peak in 1970, involved 700 people, 600 of whom were stationed in Vietnam, the rest at headquarters.⁹ Stated in other terms, 12 percent of the DDP's manpower was devoted to Vietnam. Clearly, the Agency's stake in the operational side of the war was significant.

At the same time, the analysts were also drawn into the war. After the initiation of the bombing campaign against North Vietnam in 1965, the Agency began receiving requests for assessments of the campaign's impact. By 1966, both the Office of Research and Reports and the Office of Current Intelligence had established special staffs to deal with Vietnam. In addition, the Special Assistant for Vietnam Affairs (SAVA) staff was created under the direction of the DCI. The total number of DDI analysts involved was 69.

While the DDP effort was increasing in proportion to the American military buildup, DDI estimates painted a pessimistic view of the likelihood of U.S. success with successive escalations in the ground and air wars.¹⁰ At no time was the institutional dichotomy between the operational and analytical components more stark.

The Agency's involvement in Southeast Asia had long-term effects on the institution. In particular, it determined the second-generation

⁹ By 1965, the demands for personnel were so great that each DDP component was levied on a quota basis to contribute personnel.

¹⁰ There were exceptions to this. The SAVA group produced some positive estimates of the bombing.

leadership group within the Agency. By 1970, the first generation of Agency careerists was beginning to reach retirement age and vacancies were opening in senior-level positions. In both the DDP and the DDI, many of those positions were filled by individuals who had distinguished themselves in Southeast Asia-related activities. In the Clandestine Service, men who spent considerable time in the Far East have gone on to become a former DCI, the present Deputy Director for Operations,¹¹ the present Chief of the Western Hemisphere Division, the Chief of the Counterintelligence Staff, and the present Deputy Chief of the Soviet/East European Division. On the DDI side, the present Assistant Deputy Director for Intelligence and the Chief National Intelligence Officer¹² were all involved in Vietnam assessments at the height of the war. Clearly, the rewards were considerable for participation in a major operation.

The decade of the 1960's brought increased attention to the problem of coordinating intelligence activities in the community but illustrated the complex difficulties involved in effective management. Departmental claims, the orientation of the DCI, the role accorded him by the President, and the demands of clandestine operations all affected the execution of the coordination role. Although policymakers were inconsistent in their utilization of the Agency's intelligence analysis capability, all continued to rely heavily on the CIA's operational capability in support of their policies. That fact established the Agency's own priorities and reinforced the existing internal incentives. Despite the Agency's growing sophistication and investment in technological systems, clandestine activities continued to constitute the major share of the Agency's budget and personnel. Between 1962 and 1970 the DDP budget averaged 52 percent of the Agency's total annual budget.¹³ Likewise, in the same period, 55 percent of full-time Agency personnel were assigned to DDP activities.¹⁴ Essentially, the pattern of activity that had begun to emerge in the early 1950's and that became firmly established under Dulles continued.

D. THE RECENT PAST: 1971-1975

The years 1971 to 1975 were a period of transition and abrupt change for the CIA. The scale of covert operations declined, and in the Executive branch and at the senior level of the Agency growing concern developed over the quality of the intelligence product and the management of the intelligence community's resources. However, external pressures overshadowed initial attempts at reform.

¹¹ In 1973 DCI James Schlesinger changed the name of the Clandestine Service from the Directorate for Plans to the Directorate for Operations (DDO).

¹² See page 123 of this section for discussion of National Intelligence Officers.

¹³ This does not include the proportion of the DDA budget that supported DDP activities.

¹⁴ This figure includes those individuals in the communications and logistics components of the DDA, whose activities were in direct support of the DDP mission.

By the start of the decade broad changes had evolved in American foreign policy. Dissension over Vietnam, the Congress' more assertive role in foreign policy, and shifts in the international power structure had eroded the assumptions on which U.S. foreign policy had been based. The consensus that had existed among the press, the informed public, the Congress, and the Executive branch and that had both supported and protected the CIA broke down. As conflicting policy preferences emerged and as misconduct in the Executive branch was revealed, the CIA, once exempt from public examination, became subject to close scrutiny.

1. The Directors of Central Intelligence, 1973-1975

James R. Schlesinger's tenure as DCI from February to July 1973 was brief but significant. An economist by training and long an observer of the intelligence community through his extensive experience in national security affairs, Schlesinger came to the CIA with definite ideas on restructuring the management of the community and on improving the quality of intelligence. During his six month term he embarked on changes that promised to alter the DCI's and the Agency's existing priorities.

William E. Colby succeeded Schlesinger. An attorney, OSS veteran, and career DDP officer, Colby's background made him seem of the traditional operations school in the Agency. His overseas assignments included positions in Rome, Stockholm, and Saigon, where he was Chief of Station. Yet Colby brought an Agency-wide and community orientation to his term as DCI that was uncommon for DDP careerists. Soon after his appointment the Agency became the focus of public and Congressional inquiries, and most of Colby's time was absorbed in responding to these developments.

2. Efforts at Change

Foreign affairs were a continuing priority in the Nixon Administration. Until 1971, Vietnam absorbed most of the time and attention of the President and his Assistant for National Security Affairs, Henry Kissinger. After 1971, both turned to a redefinition of U.S. foreign policy. Sharing a global view of U.S. policy, the two men sought to restructure relationships with the Soviet Union and with the People's Republic of China. It was Kissinger rather than Richard Helms who served as President Nixon's intelligence officer. Kissinger provided Nixon with daily briefings and relied on the staff of the National Security Council for intelligence analysis.

Both men's preference for working with (and often independently of) small, tightly managed staffs is well known. However, both were genuinely interested in obtaining more and better quality intelligence from the CIA. In December 1970, Nixon requested a study of the intelligence community. Executed by James Schlesinger, then Assistant Director of the Bureau of the Budget, the study resulted in the Presidential directive of November 5, 1971, assigning the DCI responsibility for review of the intelligence community budget. The intention was that the DCI would advise the President on community-wide budgetary allocations by serving in a last review capacity. The effort faltered for two reasons. First, Nixon chose not to request Congressional enactment of revised legislation extending the authority of the DCI. The

decision inherently limited the DCI's ability to exert control over the intelligence components. Thus, the DCI was once again left to arbitrate as one among equals. Second, the implementation of the directive was less energetic and decisive than it might have been. Helms did not attempt to make recommendations on budgetary allocations and instead, presented the President with the agreed views of the representatives of the departmental intelligence components. Furthermore, within the Agency, the mechanism for assisting the DCI in community matters was weak. Early in 1972 Helms established the Intelligence Community (IC) Staff as a replacement for the NIFE staff to assist in community matters. Between the time of the decision to create such a staff and its actual organization, the number of personnel assigned was halved.

It is likely that had James Schlesinger remained as DCI, he would have assumed a vigorous role in the community, and would have attempted to exercise the DCI's implied authority. Schlesinger altered the composition of the IC staff by reducing the number of CIA personnel and increasing the number of non-Agency personnel to facilitate the staff's contacts with the community. Schlesinger's primary concern was upgrading the quality of the Agency's intelligence analysis, and he had begun to consider changes in the Office of National Estimates. In addition, he made considerable reductions in personnel—with most of the cuts occurring in the DDO.¹⁴

Under Colby, attempts at innovation continued. Colby abolished the Office of National Estimates and replaced it with a group of eleven senior specialists in functional and geographical areas known as National Intelligence Officers (NIOs). NIOs are responsible for intelligence collection and production in their designated fields, and the senior NIO is directly responsible to the DCI. The purpose of the NIO system was to establish better communication and interchange between policymakers and analysts than had been the case with the Office of National Estimates.

These changes were accompanied by shifts in emphasis in the DDO and the DDI. In the Clandestine Service the scale of covert operations was reduced, and by 1972 the Agency's paramilitary program in Southeast Asia was dissolved. Yet, the overall reduction did not affect the fundamental assumptions, organization, and incentives governing the DDO. Indeed, in 1975 clandestine activities still constituted 37 percent of the Agency's total budget.¹⁵ The rationale remains the same, and the operational capability is intact—as CIA activities in Chile illustrated. While Soviet strategic capabilities remain the first priority for clandestine collection requirements, in response to recent international developments, the DDO has increased its collection activities in the areas of terrorism and international narcotics traffic—with considerable success.

In the DDI, economic intelligence has continued to assume increased importance and taken on new dimensions. In sharp contrast to the British intelligence service, which has for generations emphasized international economics, the DDI only recently has begun developing a capability in such areas as international finance, the gold market,

¹⁴ See footnote, p. 121.

¹⁵ This does not include DDA budgetary allocations in support of DDO activities.

and international economic movements. The real impetus for this change came in August 1971 with the U.S. balance of payments crisis. Since that time, and with subsequent international energy problems, the demands for international economic intelligence have escalated dramatically.

The Agency's technological capabilities have made a sustained contribution to policymaking. By providing the first effective means of verification, CIA's reconnaissance systems facilitated the United States' participation in arms control agreements with the Soviet Union, beginning with the 1972 Interim Agreement limiting strategic arms.

In December 1974 these developments and the impetus for change begun under Schlesinger were overtaken by public revelations of alleged CIA domestic activities. What had been a consensual acceptance of the CIA's right to secrecy in the interests of national security was rejected. The Agency's vulnerability to these public revelations was indicative of the degree to which American foreign policy and the institutional framework that supported that policy were undergoing redefinition.

E. CONCLUSION

A brief history cannot catalogue the many shifts in the numerous CIA subdivisions over a period of nearly thirty years. Instead, this summary has attempted to capture the changes in the CIA's main functional areas. Sharing characteristics common to most large, complex organizations, the CIA has responded to, rather than anticipated, the forces of change; it has accumulated functions rather than redefining them; its internal patterns were established early and have solidified; success has come to those who have made visible contributions in high-priority areas. These general characteristics have affected the specifics of the Agency's development:

—The notion that the CIA could serve as a coordinating body and that the DCI could orchestrate the process did not take into account inherent institutional obstacles. Vested departmental interests and the Departments' control over budget and management choices frustrated the Agency's and the DCI's ability to execute the coordination function. These limitations exist today, when the resources and complexities of administration have escalated dramatically.

—The DDO and the DDI evolved out of separate, independent organizations, serving different policy needs. Strict compartmentation in the DDO reinforced the separation. The two components were not mutually supportive elements in the collection and analysis functions.

—The activities of the Clandestine Service have reflected not what the Agency can do well but what the demands of American foreign policy have required at particular times. The nature of covert operations, the priority accorded them by senior policymakers, and the orientation and background of some DCIs have made the clandestine mission the preeminent activity within the organization.

—The qualities demanded of individuals in the Clandestine Service—essentially management of people, provide the basis for bureaucratic skills in the organization. These skills account for the fact that those DCIs who have been Agency careerists have all come from the DDO.

—Growth in the range of American foreign policy interests and the DDI's response to additional requirements have resulted in an increased scale of collection and analysis. Rather than rectifying the problem of duplication the Agency has contributed to it by becoming yet another source of intelligence production. The DDI's size and the administrative process involved in the production of finished intelligence precluded close association between policymakers and analysts, between the intelligence product and policy informed by intelligence analysis.

The relationship between intelligence analysis and policymaking is a reciprocal one. The creation of the NIO system was in part a recognition of the need for close interaction between analysts and their clients. If intelligence is to influence policy and if policy needs are to direct intelligence priorities, senior policymakers must actively utilize the intelligence capabilities at their disposal. For policymakers not to do so only wastes resources and encourages lack of direction in intelligence production. Likewise, the Director of Central Intelligence or his successor for management of the community must assign priority attention to the roles of principal intelligence adviser to the President and head of the intelligence community. History has demonstrated that the job of the DCI as community manager and as senior official of the Agency are competing, not complementary roles. In the future separation of the functions may prove a plausible alternative.

Clandestine activities will remain an element of U.S. foreign policy, and policymakers will directly affect the level of operations. The prominence of the Clandestine Service within the Agency may moderate as money for and high-level Executive interest in covert actions diminish. However, DDO incentives which emphasize operations over collection and which create an internal demand for projects will continue to foster covert action unless an internal conversion process forces a change.

Over the past thirty years the United States has developed an institution and a corps of individuals who constitute the U.S. intelligence profession. The question remains as to how both the institution and the individuals will best be utilized.



VII. THE CENTRAL INTELLIGENCE AGENCY: STATUTORY AUTHORITY

The National Security Act of 1947 provides the Central Intelligence Agency with statutory authority for its activities. Section 102(d) of that Act lists the following "powers and duties" for the Agency:

(1) to advise the National Security Council in matters concerning such intelligence activities of the Government departments and agencies as relate to national security;

(2) to make recommendations to the National Security Council for the coordination of such intelligence activities of the departments and agencies of the Government as relate to the national security;

(3) to correlate and evaluate intelligence relating to the national security, and provide for the appropriate dissemination of such intelligence within the Government using where appropriate existing agencies and facilities: *Provided*, That the Agency shall have no police, subpoena, law-enforcement powers, or internal-security functions: *Provided further*, That the departments and other agencies of the Government shall continue to collect, evaluate, correlate, and disseminate departmental intelligence: *And provided further*, That the Director of Central Intelligence shall be responsible for protecting intelligence sources and methods from unauthorized disclosure:

(4) to perform, for the benefit of the existing intelligence agencies, such additional service of common concern as the National Security Council determines can be more efficiently accomplished centrally;

(5) to perform such other functions and duties related to intelligence affecting the national security as the National Security Council may from time to time direct.¹

The CIA has engaged in the following three types of activities, none of which is specifically mentioned in the 1947 legislation: (1) direct clandestine collection of intelligence; (2) covert action; and (3) direct collection of information regarding the activities of American nationals within the United States. As the fact of CIA involvement in these activities has become widely known, questions have been raised regarding the statutory authority by which the Agency undertook these responsibilities.

It is important to note at this point that the confusion which has resulted from the lack of specific legislative guidelines with respect to these three kinds of activities must rest with Congress. The language of the National Security Act, its legislative history, and the post-enactment interpretation of the legislation by Congress itself indicates that the Act can legitimately be construed as authorizing clandestine collection by the CIA. The Select Committee's record shows that the legislating committees of the House and Senate intended for the Act to authorize the Agency to engage in espionage. This activity could and should have been specifically authorized in the 1949 legislation.

¹50 U.S.C. 403(d).

Authority for covert action cannot be found in the National Security Act. The Committee finds that the executive branch should have approached Congress for authority for the CIA to engage in such activities, particularly where they involved the use of force. At the same time, Congress should have acted in response to well-publicized instances of covert action to clarify CIA authority in this area.

Finally, Congress did take decisive action in the National Security Act of 1947 to prevent the CIA's assuming any police, law-enforcement, or internal security function in the United States. Some of the CIA's activities have been in clear violation of that principle. Congress now has a responsibility, however, to clarify the Agency's authority where CIA's domestic activities are directly linked to its foreign intelligence responsibilities.

A. CLANDESTINE COLLECTION OF INTELLIGENCE

While the National Security Act of 1947 authorizes correlation, evaluation, and dissemination of national security intelligence by the CIA, nowhere does it specify that the Agency is authorized to engage in the direct collection of intelligence. As its authority to engage in direct collection, the CIA has relied upon Section 102(d) (4) and (5) of the Act,¹⁴ which authorizes the Agency:

(4) to perform, for the benefit of the existing agencies, such additional services of common concern as the National Security Council determines can be more efficiently accomplished centrally;

(5) to perform such other functions and duties related to intelligence affecting the national security as the National Security Council may from time to time direct. 50 U.S.C. 403 (d) (4) and (5).

The legislative history of the 1947 Act does not indicate clearly that the full Congress specifically intended by these provisions to authorize direct clandestine collection by the CIA. The legislating committees discussed the issue in some detail in executive session, but it was mentioned only briefly in public hearings and floor debates. However, the public record does suggest that the full Congress had access to information which indicated that the Act could be construed as authorizing direct collection. No action was taken to prohibit such activity. Moreover, the 1949 enactment of the Central Intelligence Agency Act demonstrates congressional intent to facilitate clandestine activities, and thus congressional endorsement of the view that such activities were the legitimate function of the CIA.

The Committee has been able to locate full records for only one of the closed committee meetings on the National Security Act. In a transcript of the June 27, 1947 meeting of the House Committee on Expenditures in the Executive Departments, executive branch representatives proposed centralization of clandestine collection in the CIA. The Committee discussed the wisdom of this proposal with a number of

¹⁴ Memorandum from the CIA General Counsel to the Director, 5/7/48; memorandum from the CIA General Counsel to the Deputy Chief for Foreign Intelligence, 4/14/61.

witnesses.² General Hoyt S. Vandenberg, then Director of Central Intelligence, suggested centralized collection to the Senate Committee on the Armed Services,³ and other executive branch personnel who participated in the preparation of the Act have stated that the Senate committee discussed the proposal.⁴ In addition, a 1961 memorandum by CIA General Counsel Lawrence Houston and recent interviews with Houston and former CIA Legislative Counsel Walter Pforzheimer indicate that the possibility of including language in the Act specifically to authorize espionage by the CIA was discussed.⁵ According to Houston and Pforzheimer, this proposal was rejected on the grounds that it would be inappropriate for the United States to be on record as a participant in this kind of activity.⁶

The House Committee was informed that the Central Intelligence Group, the predecessor agency to the CIA, had engaged in clandestine collection, and that it relied for its authority upon language in subsections 3 (c) and (d) of the Presidential Directive of January 22, 1946 establishing the CIG.⁷ The Committee was therefore specifically on notice that this language, which is almost identical to Section 102(d) (4) and (5) of the National Security Act of 1947, had been considered sufficiently broad to authorize direct clandestine collection. (The Presidential Directive, like the 1947 Act, does not mention collection of any kind.)

Committee reports on the National Security Act make no reference to a collection role for the CIA. In open committee hearings very little was said about the issue. Occasional remarks do indicate, however, that the Agency would perform some kind of collection function. In testimony before the Senate Armed Services Committee, General Vandenberg said that the CIA would collect "foreign intelligence information of certain types."⁸ Earlier in his testimony General Vandenberg had referred to "certain . . . activities" which intelligence agencies such as the CIA, military intelligence, and the FBI could not "expose . . . to the public gaze."⁹ General Vandenberg had spoken with some specificity of the need for centralizing clandestine collections in the CIA before both the House and Senate Committees in closed session. It can be assumed that these additional remarks, which were released to the public, referred to clandestine collection as well.

² Transcript, House Committee on Expenditures in the Executive Departments, Hearings on H.R. 2310, 6/27/47 (hereinafter cited as House transcript), pp. 10-19, 53-55, 70-80, 111-112, 118-125, 134-135, 150-164.

³ Testimony of General Hoyt S. Vandenberg, Director of Central Intelligence (unsanitized, now declassified), Senate Armed Services Committee, Hearings on S. 758, 4/20/47.

⁴ Staff summary of Walter Pforzheimer, former CIA Legislative Counsel, interview, 3/4/76.

⁵ Memorandum from the CIA General Counsel to the Deputy Chief for Foreign Intelligence, 4/14/61; staff summary of Lawrence Houston interview, 6/4/75; staff summary of Walter Pforzheimer interview, 5/20/75.

No discussion of such a proposal is reported in the public record, but the House committee executive session transcript contains brief references to it. Allen Dulles testimony, House transcript, p. 50.

⁶ Houston (staff summary), 6/4/75.

⁷ General Hoyt S. Vandenberg testimony, Peter Vlacher testimony, House transcript, pp. 10, 76.

⁸ Vandenberg, Senate Armed Services Committee, Hearings, 4/20/47, p. 406.

⁹ *Ibid.*, (p. 402).

Little more was said in public. During the House floor debates, Rep. Busbey, a member of the Committee on Expenditures, expressed objection to clandestine collection by the CIA and said he hoped the bill would be amended to prohibit such activity.¹⁰ No such amendment was adopted, however, and Rep. Holifield, another member of the committee, later remarked:

I want to impress upon the minds of the Members that the work of this Central Intelligence Agency, as far as the collection of evidence is concerned, is strictly in the field of secret foreign intelligence—what is known as clandestine intelligence.¹¹

The remarks of Representatives Busbey and Holifield indicate that it was anticipated that the authority conveyed by the bill extended to clandestine collection by the CIA. Still later in the floor debate, however, Rep. Patterson stated that while he clearly wanted "an independent intelligence agency, working without direction by our armed services, with full authority in operational procedures," he knew that it was "impossible to incorporate such broad authority in the bill now before us."¹² Rep. Patterson may have been expressing regret that the National Security Act did not authorize the CIA to engage in direct collection of intelligence; he may have been expressing the view that the Act would not give the CIA full independence in its operations from the armed services; or he may have been referring to what we now describe as covert action.

Public references to collection are too obscure and in some cases too ambiguous for the inference to be drawn that the full Congress specifically intended to authorize direct collection by the CIA. It would require an attentive legislator, alert to the full record, to be apprised of the possibility of CIA participation in this activity through the public hearings and debates. But the language of Section 102(d) (4) and (5) indicates that the Congress intended some flexibility in the operations of the CIA. These provisions are sufficiently broad that clandestine collection of information could reasonably fall within the range of activities which they describe. There is no substantial evidence that Congress intended specifically to exclude clandestine collection from the "services of common concern . . . for the benefit of existing agencies" or from the "other functions and duties related to intelligence affecting the national security" which were authorized by the Act.

Two years after the enactment of the National Security Act, Congress passed the Central Intelligence Agency Act of 1949, 50 U.S.C. 403a-403j. The 1949 legislation was an enabling act; technically it contributed nothing to the kinds of activities which the Agency was authorized to carry out. Its enactment, however, sheds some light upon what Congress thought it had authorized in 1947.

There is no doubt that the purpose of certain provisions of the 1949 Act was to protect clandestine activities of the CIA. The Act waives the normal restrictions placed on government acquisition of materiel, hiring, and accounting for funds expended. If Congress did not be-

¹⁰ 93 Cong. Rec. 9404 (1947).

¹¹ *Ibid.*, p. 9430.

¹² *Ibid.*, p. 9447.

lieve that some type of clandestine activity had been authorized by the National Security Act, these provisions would not have been necessary.

Further, the Congress had reason to believe that the CIA was already engaged in espionage. Prior to passage of the Act, there had been discussion in the press of CIA involvement in direct clandestine collection.¹³ Clandestine collection was specifically discussed in closed hearings on the Act,¹⁴ and finally, in floor debates Members of Congress referred to the legislation as "an espionage bill."¹⁵ While there was much debate on the floor of both Houses as to the wisdom of specific provisions of the bill and the general need for secrecy in the enactment process, no one suggested that the provisions of the bill were unwarranted because the operations which they were designed to facilitate were not authorized by law.

The Central Intelligence Agency Act appears to represent congressional endorsement of the view that the National Security Act had authorized the CIA to engage in direct clandestine collection. That is a view consistent with the language of the National Security Act and, to the degree that the history addresses the issue, with its legislative history.

B. COVERT ACTION

Covert action is defined as clandestine activity designed to influence foreign governments, events, organizations or persons in support of U.S. foreign policy conducted in such a way that the involvement of the U.S. Government is not apparent. In its attempts directly to influence events it is distinguishable from clandestine intelligence gathering—often referred to as espionage. It has been argued that authority for the CIA to conduct covert action can be found in the 1947 National Security Act, the 1949 Central Intelligence Agency Act and the post enactment interpretation of those acts by the Congress and the Executive.

The National Security Act contains no reference to covert action. Section 102(d) (5) of the Act has been cited, however, as the statutory basis for covert action. That paragraph provides that the Agency shall "perform such other functions and duties related to intelligence affecting the national security as the National Security Council may, from time to time, direct." Paragraph 5 was cited by the National Security Council in authorizing covert action by the CIA in NSC-4-A and NSC 10/2.

The language of 50 U.S.C. 403(d) (5) may in fact authorize a broad range of activities not otherwise specified in the Act. An important limitation on such authorization, however, is that the activities must be "related to intelligence affecting the national security." Many covert actions are "related to intelligence" in the sense that their performance is tied to clandestine intelligence operations, uses the same meth-

¹³ "The X at Bogota," *The Washington Post* 4/13/48; Hanson W. Baldwin, "Intelligence—II," *The New York Times*, 7/22/48.

¹⁴ Gen. Hoyt S. Vandenberg testimony, House Armed Services Committee Hearing on H.R. 5671, 4/8/48. (The CIA Act was not passed by the 80th Congress in 1948, but the same bill reported by the House Armed Services Committee in 1948 was enacted by the 81st Congress in 1949.)

¹⁵ 95 Cong. Rec. 1946, 1947 (1949).

ods, and yields an intelligence product. It must be noted, however, that the chief purpose of these operations is not to gather intelligence, and that many covert actions, such as the invasion of the Bay of Pigs, have only the most limited relationship to "intelligence affecting the national security."

Given the fact that some of the actions which the CIA has taken to influence events in other countries are arguably "related to intelligence affecting the national security", again it may be useful to examine the legislative history of the National Security Act to determine if these forms of covert action were within the range of activities which Congress intended to authorize. But there is little in the public record or even in the House Committee's executive session transcript which sheds any light on the intent of Congress with respect to covert action. Occasional references were made to "operational activities",¹⁶ "special operations",¹⁷ or "operational procedures,"¹⁸ but the context of these remarks indicates that they were at least as likely to refer to the clandestine collection of intelligence as to covert action. In any case, these terms were never used in such a way as to indicate clearly that the Congress intended to authorize the activities which they encompassed. A memorandum by the CIA's general counsel, written soon after the passage of the Act, concedes that the legislative history contains nothing to show that Congress intended to authorize covert action by the CIA.¹⁹

Neither the 1947 Act nor its legislative history, however, indicates congressional intent to prohibit covert actions by the Agency. As previously noted, the Executive had intended from the outset that the CIA would engage in clandestine collection of intelligence. The flexibility which 50 U.S.C. 403(d)(5) conveyed to the Agency, together with the capacity to act in secret which was being developed in connection with its clandestine collection function, made the CIA an attractive candidate to carry out these additional sensitive operations. The executive branch was soon to seize upon this flexibility and assign major covert operations to the Agency.

In December 1947 the National Security Council instructed the CIA to undertake covert psychological operations.²⁰ Six months later the NSC vastly expanded the range of covert activities authorized to include:

propaganda; economic warfare; preventive direct action, including sabotage, anti-sabotage, demolition and evacuation measures; subversion against hostile states, including assistance to guerrilla and refugee liberation groups, and support of indigenous anti-Communist elements in the threatened countries of the free world.²¹

Under the authority of 50 U.S.C. 403 (d) (5), there was established an Office of Special Projects to conduct covert actions.²²

¹⁶ James Forrestal testimony, House Committee on Expenditures in the Executive Departments. Hearings on H. R. 2319, 1947, p. 120.

¹⁷ Memorandum from Allen Dulles, 4/25/47, Senate Armed Services Committee. Hearings on S. 758, p. 520.

¹⁸ 93 Cong. Rec., 9447, 1947.

¹⁹ Memorandum from the CIA General Counsel to the Director, 9/25/47.

²⁰ NSC-4-A, 12/17/47.

²¹ NSC Directive, 6/18/48.

²² *Ibid.*

All of this occurred prior to enactment of the Central Intelligence Agency Act in 1949. As noted previously, the CIA Act included provisions the clear purpose of which was to protect the security of secret operations. What is not clear is whether these operations were meant by the Congress to include covert action as we now understand the term.

By 1948 the CIA was already engaged in a variety of covert actions. In seeking passage of the Central Intelligence Agency Act the Executive anticipated that its provisions would facilitate these operations, as well as covert collection. Remarks in executive session of the House Committee on Armed Services indicate that such operations were used to justify passage of the Act, and that this committee knew that plans for covert action were then pending which the Act was necessary to implement.²³

There is no evidence that the full Congress, on the other hand, knew or understood the range of clandestine activities, including covert action, which the Executive was undertaking. The Committee reports on the bills that were to become the Central Intelligence Agency Act include no reference to covert action, and the floor debates do not indicate that the Congress knew that covert action, as opposed to clandestine intelligence gathering, was being or would be undertaken by the CIA.²⁴ Thus, while the very nature of some of the provisions of the 1949 Act indicates that the Congress assumed that the CIA would engage in some clandestine activities, and while the legislative history of that Act indicates that these operations were expected to include espionage, there is nothing in the legislation or its history to indicate that the full Congress meant by the Act to facilitate covert action.

It has been suggested that congressional provision of funds to the CIA indicates congressional approval of, or authorization for the CIA's conduct of covert action. Such a premise was offered in a 1962 internal memorandum of the Agency's General Counsel²⁵ and in a Justice Department memorandum dated two days later.²⁶ In December 1975 this argument was made publicly by the Special Counsel to the Director of the CIA in testimony before the House Select Committee on Intelligence. The Special Counsel said that given "CIA reporting of its covert action programs to Congress, and congressional appropriation of funds for such programs" the "law is clear that, under these circumstances, Congress has effectively ratified the authority of the CIA to plan and conduct covert action under the direction of the President and the National Security Council."²⁷

The principal problem with this analysis is, that the CIA has not reported its covert action programs to Congress as a whole, but only

²³ Vandenberg, House Armed Services Committee Hearings on H.R. 5871, 4/8/48.

²⁴ It was remarked in the House debates, however, in the context of a discussion of intelligence gathering that "in spite of all our wealth and power and might we have been extremely weak in psychological warfare, notwithstanding the fact that an idea is perhaps the most powerful weapon on this earth." 95 Cong. Rec. 1047 (1949).

²⁵ Memorandum from the CIA General Counsel to the Director, 1/15/62, p. 2.

²⁶ Memorandum, Office of Legislative Counsel, Department of Justice, 1/17/62, pp. 12-13.

²⁷ Testimony of Mitchell Rogovin, Special Counsel to the Director of Central Intelligence, House Select Intelligence Committee Hearings, 12/9/75, pp. 1735-1736.

to a few members of a few committees of Congress. Small subcommittees of the Armed Services and Appropriations Committees in each House were briefed to some extent on these activities until 1974, when the Foreign Assistance Act was amended to require that six committees of Congress be informed with respect to those foreign activities of the CIA which are not intended solely for obtaining necessary intelligence.

Other members of Congress may ultimately have become generally aware that the CIA engaged in some non-intelligence production operations; the role of the CIA in the Bay of Pigs operation, for example, was widely known. Still it cannot be said that Congress as a whole, knowing that the Agency made a practice of covert actions, ratified such operations by appropriating funds for them. The Congress as a whole has never voted for appropriations for the CIA. The funds provided to the CIA are concealed in the appropriations made to other agencies, they are then transferred to the CIA, pursuant to the provisions of the CIA Act of 1949, with the approval of the OMB and selected members of the Appropriations Committees. Congress as a whole has known neither how much the CIA would receive nor where the funds which would be transferred to the CIA were concealed. A question has been raised as to whether the CIA is even "appropriated" funds pursuant to constitutional requirements.²⁸

More convincing than the argument that Congress has ratified covert action by appropriation is the suggestion that ratification has been by acquiescence. Although the Congress as a whole has not made appropriations for covert action, in recent years it has been aware that funds for such operations were being channeled to the CIA. Congress has had the power to put an end to these activities by attaching conditions to the use of funds appropriated by it. The failure to exercise this power may be interpreted as congressional ratification of CIA authority.

In December 1974 the Congress passed a set of amendments to the Foreign Assistance Act of 1961. Section 32 of these amendments, which became Section 662 of the 1961 Act and is known as the Hughes-Ryan Amendment, provides:

Limitations on intelligence activities.—(a) No funds appropriated under authority of this or any other act may be expended by or on behalf of the Central Intelligence Agency for operations in foreign countries, other than activities intended solely for obtaining necessary intelligence, unless and until the President finds that each such operation is important to the national security of the United States and reports, in a timely fashion, a description and scope of such operation to the appropriate committees of the Congress, including the Committee on Foreign Relations of the United States Senate and the Committee on Foreign Affairs of the United States House of Representatives. (b) The provisions of subsection (a) of this section shall not apply during military operations initiated by the United States under a declaration of war approved by the Congress or an exercise of powers by the President under the War Powers Resolution, 22 U.S.C. 2422.

²⁸ Elliot Maxwell, "The CIA's Secret Funding and the Constitution," *Yale Law Journal*, Vol. 84 (1975), pp. 608-636.

The Hughes-Ryan Amendment was cited by the Special Counsel to the Director of the Central Intelligence Agency when he appeared before the House Select Committee on Intelligence to argue that Congress has "both acknowledged and ratified the authority of the CIA to plan and conduct covert action." He said that the provision "clearly implies that the CIA is authorized to plan and conduct covert action."²⁹ ²⁰

Section 32 does not explicitly authorize covert action by the Central Intelligence Agency. On its face it contributes nothing to the CIA's authority to do anything. It can be argued, however, that the amendment represents recognition by the Congress that authority for the CIA to engage in covert action does exist. This argument has considerable merit. While certain restrictions were placed upon the conduct of covert action, it was not foreclosed as it could have been. On the other hand, it can be argued that the amendment merely represents Congress' acknowledgement that the CIA does carry out non-intelligence production activities. The purpose of Section 32 was to acquire information about these operations so that a decision could be made about their legitimacy. This argument is bolstered by the fact that a number of the proponents of the amendment, including its sponsor in the Senate, saw the amendment as a temporary measure. Senator Hughes stated on the floor that the measure "provides a temporary arrangement, not a permanent one, recognizing that a permanent arrangement is in the process of being developed."³⁰ Thus the amendment might be seen not as congressional ratification of the CIA's authority to conduct covert action, but as a temporary measure to place limits on what the CIA was doing anyway. At the same time, the measure requires reporting so that Congress, traditionally deprived of information about covert action, can determine what further action to take with respect to this activity.

The significance of the events up to 1974 is that until that date Congress could escape a full share of responsibility for the CIA's covert actions. Enactment of the Hughes-Ryan Amendment, however, does represent formal acknowledgement by Congress that the CIA engages in operations in foreign countries for purposes other than obtaining intelligence. Since passage of that Act, six standing committees of Congress have received information on specific CIA covert actions, and public hearings have been held on the subject by the Select Committee. The full Congress now has information on covert action, and it has the power to prohibit or further restrict this activity, either directly or through limitations on the expenditure of funds. If Congress takes no such action, a convincing argument can be made that it has authorized covert action by acquiescence.

C. DOMESTIC ACTIVITIES

The record shows that the CIA has engaged in a variety of clandestine collection programs directed at the activities of Americans within the United States. Some of these activities have raised constitutional

²⁹ Rogovin, House Select Committee on Intelligence, Hearings, 12/9/75, p. 1734.

³⁰ Cong. Rec. 818062, daily ed., 10/2/74.

questions related to the rights of Americans to engage in political activity free from government surveillance. But they have also raised questions about (1) the authority of the CIA, under its charter, to collect and use information about Americans, and (2) the extent to which the specific statutory prohibition on police and internal security functions by the CIA restricts these domestic activities.

The National Security Act of 1947 defines the duties of the CIA in terms of "intelligence" or "intelligence relating to the national security." The legislative history of the Act clearly shows that Congress intended the activities authorized by this language to be related to foreign intelligence.³¹ This construction is aided by the statute's provision that "the Agency shall have no police, subpoena, law enforcement power, or internal-security functions," (50 U.S.C. 403(d)(3)). In recent years, however, the executive branch has interpreted foreign intelligence broadly to include intelligence programs the purpose of which is to determine foreign influence on dissident domestic groups. These programs have involved intelligence gathering within the United States directed at United States nationals. They have continued, under Presidential orders, even when no significant foreign connections were found. Even if these investigations had been based at the outset upon specific evidence of contact between domestic groups and hostile foreign governments or powers, however, and even if they had been terminated immediately when they revealed no foreign threat, a question arises as to whether such investigations would be authorized by the National Security Act.

The legislative history of the Act shows that in establishing the CIA Congress contemplated an agency which not only would be limited to foreign intelligence operations but one which would conduct very few of its operations within the United States. It was contemplated that the Agency would have its headquarters here,³² and in House Committee hearings in executive session the possibility of seeking foreign intelligence information from private American citizens who traveled abroad was discussed with approval.³³ But in public and in private it was generally agreed among legislators and representatives of the Executive that the CIA would be "confined out of the continental limits of the United States and in foreign fields,"³⁴ that it should

³¹ The purpose of the CIA was to take over the functions of the CIG, which had acted as a foreign intelligence agency. The assumption that the CIA would continue in the foreign intelligence field underlies much of the legislative debates over Section 102 of the National Security Act. For example, in the House floor debates it was remarked that, "The Central Intelligence Agency deals with intelligence outside the United States," 83 Cong. Rec. 9494 (1947), that "the Central Intelligence Agency is supposed to operate only abroad" (*Ibid.*, p. 9458) and that "the Central Intelligence Agency deals only with external security" (*Ibid.*, p. 9447). It was frequently remarked that the Agency was not to be permitted to act as a domestic police or "Gestapo." [Senate Armed Services Committee, Hearings on S. 758, (1947), p. 497; House Expenditures in the Executive Departments Committee, Hearings on H.R. 2319 (1947), pp. 127, 338, 470-481; 93 Cong. Rec. 9413, 9422, 9443 (1947).] Specific care was taken to prevent the CIA or the Director of Central Intelligence from interfering in any way with the functions of the FBI [see 50 U.S.C. 403 (e) and 93 Cong. Rec. 9447-9448 (1947).]

³² Vandenberg testimony, House transcript, 6/27/47, p. 60.

³³ Allen Dulles testimony, *Ibid.*, p. 52-53, 66.

³⁴ *Ibid.*, p. 59.

have no "police power or anything else within the confines of this country,"³⁵ and that it was "supposed to operate only abroad."³⁶

This view was reiterated in the legislative history of the Central Intelligence Agency Act of 1949. The following exchange took place between Rep. Holifield and Rep. Sasser of the House Committee on the Armed Services, which had reported the 1949 bill:

Mr. HOLIFIELD. I would like to question the gentleman from Missouri. On page 4 of the report, subsection 5(b), it is provided that an employee while in this country on leave may be assigned to temporary duty in the United States for special purposes or reorientation prior to returning to foreign service.

In the original unification bill passed through the Committee on Expenditures, of which I am a member, we had the setting up of this CIA. It was clearly brought out at that time that no internal security work of any kind would be done by the CIA: that all of its intelligence work would be done in a foreign field. In view of this particular paragraph here I want to be assured at this time that such special duties as are mentioned here, or reorientation, do not apply to security functions in the United States.

Mr. SASSER. Mr. Speaker, if the gentleman will yield, I will say to the gentleman that that is correct, that this bill is in no wise directed to internal security. If they come back here it is purely a matter of leave, and reorientation, and training to go back into their work in foreign countries. 95 Cong. Rec. 1947-1948 (1949).

The bill which had been submitted by the Executive to establish the Agency in 1947 incorporated by reference the provisions of the Presidential Directive of January 22, 1946, which established the CIG and provided that it would have "no police, law enforcement or internal security functions."³⁷ Partly in an effort to ensure that the CIA did not exceed the bounds which Congress contemplated for its activities, the bill was amended to include this prohibition and other provisions of the 1946 Directive in its text. Members of Congress were concerned that the Directive could be amended, without consulting Congress, to assign to the CIA responsibilities which would affect the rights of the American people.³⁸

³⁵ *Ibid.*, p. 60.

³⁶ 93 Cong. Rec. 9448 (1947).

³⁷ The Presidential Directive also specified at Section 9 that "Nothing contained herein shall be construed to authorize the making of investigations inside the continental limits of the United States and its possessions except as provided by law and Presidential Directives." According to Lawrence Houston, this provision had been added to the Directive at the request of the FBI, which was concerned that the CIG should not become involved in investigating subversive groups in the United States. It was not included in the statutory draft, however, because of an agreement between the CIG and the FBI that CIG could gather foreign intelligence within the United States from such sources as businessmen who traveled abroad. (Lawrence Houston testimony, President's Commission on CIA Activities, 3/17/75, pp. 1656-1657.)

³⁸ Dulles testimony, House transcript, 6/27/47, pp. 57-58. When General Vandenberg was consulted about this possibility in executive session of the House Committee on Executive Expenditures, he responded, "No sir; I do not think there is anything in the bill, since it is all foreign intelligence, that can possibly affect any of the privileges of the people of the United States." But Congress continued to be concerned about the potential for a secret domestic police in the CIA. As Rep. Brown responded to General Vandenberg, "There are a lot of things that might affect the privileges and rights of the people of the United States that are foreign, you know." (Vandenberg testimony *Ibid.*, p. 32.)

By codifying the prohibition against police and internal security functions, Congress apparently felt that it had protected the American people from the possibility that the CIA might act in any way that would have an impact upon their rights.

The CIA, however, has interpreted the internal security prohibition narrowly to exclude investigations of domestic activities of American groups for the purpose of determining foreign associations. But history indicates that at the time of enactment of the National Security Act, threats to "internal security" were widely understood to include domestic groups with foreign connections. Investigations by the FBI of American groups with no such connections, in fact, have been a recent phenomenon. The original order from President Roosevelt to J. Edgar Hoover to begin internal security operations was to investigate foreign communist and fascist influence within the United States.³⁹ There is no evidence that by 1947 these investigations were considered foreign intelligence.

The CIA's domestic intelligence programs have not relied for their authority solely upon the premise that the agency's mandate to engage in foreign intelligence activities includes information gathering on foreign contacts of domestic groups. As authority for some of its operations with the United States, the Agency has relied upon Section 102(d) (3) of the National Security Act, which charges the Director of Central Intelligence with responsibility to protect intelligence sources and methods from unauthorized disclosure.⁴⁰

The CIA has construed the sources and methods language broadly to authorize investigation of domestic groups whose activities, including demonstrations, have potential, however remote, for creating threats to CIA installations, recruiters or contractors. In the course of carrying out these investigations the Agency has collected general information about the leadership, funding, activities, and policies of targeted groups.

These activities have raised serious questions as to (1) whether such a broad interpretation of the sources and methods language is consistent with the intent of Congress in enacting that provision, and (2) again, whether such an interpretation is consistent with the statutory prohibition against conduct by the CIA of internal security functions.

The sources and methods language was discussed only briefly in the recorded legislative history of the National Security Act. As originally drafted, the proposed Act had charged the Director with "fully" protecting sources and methods. In the House Committee executive session, however, General Vandenberg suggested that the Director could not possibly "fully" protect sources and methods, and the word "fully" was subsequently dropped.⁴¹ According to the former General Counsel to the CIA, who was privy to many of the discussions and debates on the legislation as it was being prepared, the purpose of the sources and methods provision was essentially to allay concern in the military services that the Agency would not operate with adequate safeguards to protect the services' intelligence secrets.⁴² Despite congressional

³⁹ See Domestic Intelligence Report, p. 25.

⁴⁰ See detailed report on CHAOS report.

⁴¹ Houston, President's Commission on the CIA, 3/17/75, pp. 1054-1055; Staff summary of Lawrence Houston interview, 6/11/75.

⁴² Vandenberg testimony House transcript, 6/27/47, p. 28.

concern, expressed again and again during hearings and floor debates on the bill, that the CIA was to have no potential for infringing upon the rights of American citizens and that it was to be virtually excluded from acting within the United States, no one questioned whether the sources and methods language would raise problems in this area. The lack of interest in the provision suggests that it was not viewed as conveying new authority to investigate; rather it charged the Director of Central Intelligence Agency with responsibility to use the authority which he already had to protect sensitive intelligence information. This could mean implementing strict security procedures within CIA facilities and conducting background investigations of CIA personnel (although according to the former Agency General Counsel, the CIA first requested that the FBI perform this investigative function; J. Edgar Hoover refused to assume this responsibility on grounds of insufficient personnel within his own Bureau⁴²). Given the prohibition against internal security functions, it is unlikely that the provision was meant to include investigations of private American nationals who had no contact with the CIA, on the grounds that eventually their activities might threaten the Agency.

⁴² Houston, President's Commission on CIA activities within the United States, 3/17/76, pp. 1655-1656.

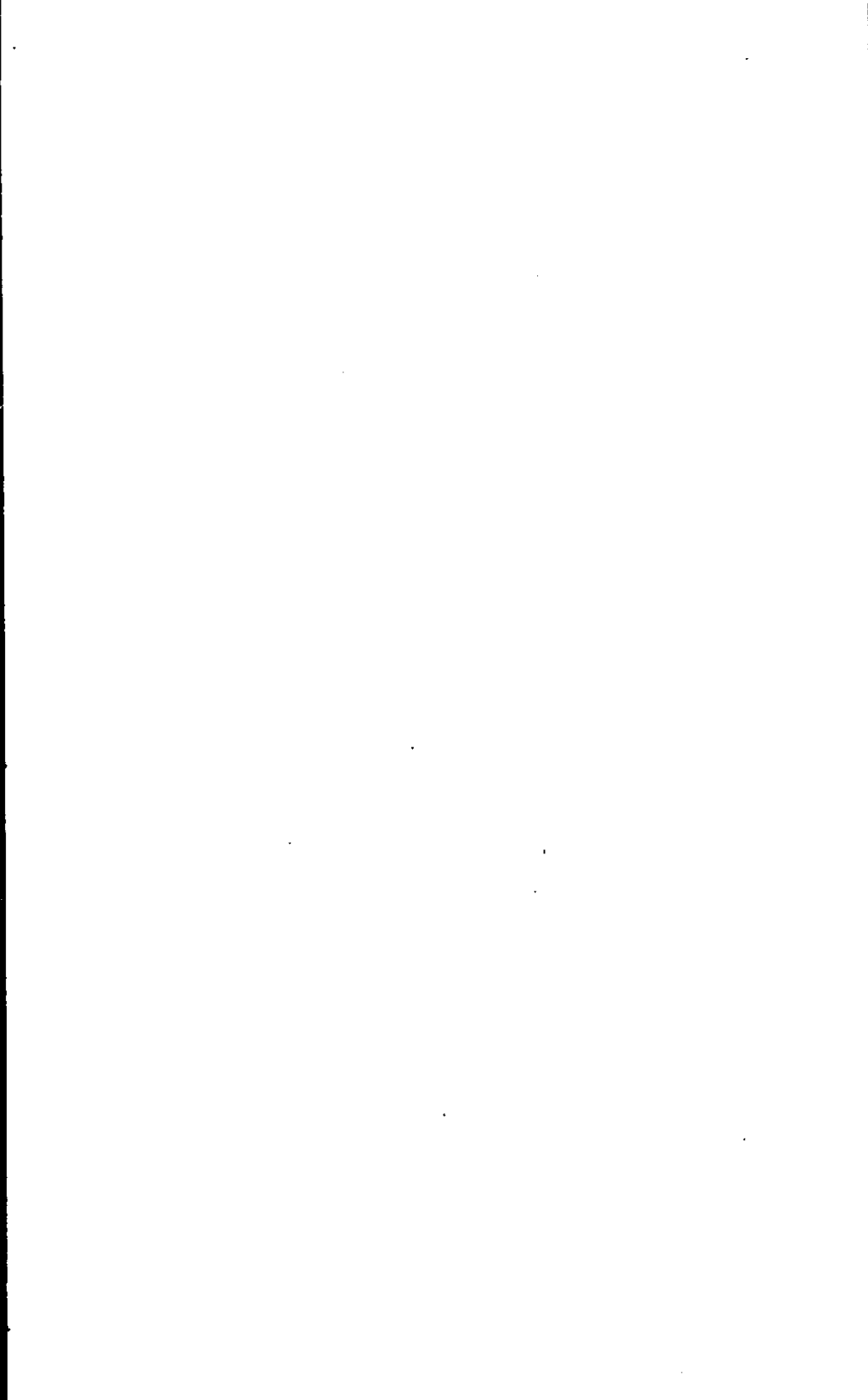

VIII. COVERT ACTION

No activity of the Central Intelligence Agency has engendered more controversy and concern than "covert action," the secret use of power and persuasion. The contemporary definition of covert action as used by the CIA—"any clandestine operation or activity designed to influence foreign governments, organizations, persons or events in support of United States foreign policy"—suggests an all-purpose policy tool. By definition, covert action should be one of the CIA's least visible activities, yet it has attracted more attention in recent years than any other United States foreign intelligence activity. The CIA has been accused of interfering in the internal political affairs of nations ranging from Iran to Chile, from Tibet to Guatemala, from Libya to Laos, from Greece to Indonesia. Assassinations, coups d'état, vote buying, economic warfare—all have been laid at the doorstep of the CIA. Few political crises take place in the world today in which CIA involvement is not alleged. As former Secretary of Defense Clark Clifford told the Committee:

The knowledge regarding such operations has become so widespread that our country has been accused of being responsible for practically every internal difficulty that has occurred in every country in the world.¹

Senate Resolution 21 authorized the Committee to investigate "the extent and necessity of overt and covert intelligence activities in the United States and abroad."² In conducting its inquiry into covert action, the Committee addressed several sets of questions:

—First, what is the past and present scope of covert action? Has covert action been an exceptional or commonplace tool of United States foreign policy? Do present covert operations meet the standard—set in the Hughes-Ryan amendment to the 1974 Foreign Assistance Act—of "important to the national security of the United States?"

—Second, what is the value of covert action as an instrument of United States foreign policy? How successful have covert operations been over the years in achieving short-range objectives and long-term goals? What have been the effects of these operations on the "targeted" nations? Have the costs of these operations, in terms of our reputation throughout the world and our capacity for ethical and moral leadership, outweighed the benefits achieved?

¹ Clark Clifford testimony, 12/6/75, Hearings, Vol. 7, p. 51.

² Senate Resolution 21, Section 2, Clause 14. The CIA conducts several kinds of covert intelligence activities abroad: clandestine collection of positive foreign intelligence, counterintelligence (or liaison with local services), and covert action. Although there are a variety of covert action techniques, most can be grouped into four broad categories: political action, propaganda, paramilitary, and economic action.

—Third, have the techniques and methods of covert action been antithetical to our principles and ideals as a nation? United States officials have been involved in plots to assassinate foreign leaders. In Chile, the United States attempted to overthrow a democratically elected government. Many covert operations appear to violate our international treaty obligations and commitments, such as the charters of the United Nations and Organization of American States. Can these actions be justified when our national security interests are at stake?

—Fourth, does the existence of a covert action capability distort the decisionmaking process? Covert operations by their nature cannot be debated openly in ways required by a constitutional system. However, has this meant that, on occasion, the Executive has resorted to covert operations to avoid bureaucratic, Congressional, and public debate? Has this contributed to an erosion of trust between the executive and legislative branches of government and between the government and the people?

—Fifth, what are the implications of maintaining a covert action capability, as presently housed in the CIA's Directorate for Operations? Does the very existence of this capability make it more likely that covert operations will be presented as a policy alternative and be implemented? Has the maintenance of this standing capability generated, in itself, demands for more and more covert action? Conversely, what are the implications of *not* maintaining a covert action capability? Will our national security be imperiled? Will our policymakers be denied a valuable policy option?

—Sixth, is it possible to accomplish many of our covert objectives through overt means? Radio Free Europe and Radio Liberty may be instructive in this regard. For years RFE and RL were operated and subsidized, covertly, by the CIA. Today they operate openly. Could other CIA covert activities be conducted in a similar manner?

—Finally, should the United States continue to maintain a covert action capability? If so, should there be restrictions on certain kinds of activities? What processes of authorization and review, both within the executive and legislative branches, should be established?

Over the past year, the Committee investigated several major covert action programs. These programs were selected to illustrate (1) covert action techniques, ranging from propaganda to paramilitary activities, from economic action to subsidizing and supporting foreign political parties, media, and labor organizations; (2) different kinds of "target" countries, from developed Western nations to less developed nations in Africa, Asia and Latin America; (3) a broad time span, from 1947 to the present; and (4) a combination of cases that the CIA considers to be representative of success and failure. One of the Committee's case studies, Chile, was the subject of a publicly released staff report.³ It served as background for the Com-

³ Senate Select Committee, "Covert Action in Chile."

mittee's public session on covert action.⁴ During its covert action inquiry, the Committee took extensive testimony in executive session and received 14 briefings from the CIA. The staff interviewed over 120 persons, including 13 former Ambassadors and 12 former CIA Station Chiefs. The successor Senate intelligence oversight committee(s) will inherit the Committee's classified covert action case studies as well as a rich documentary base for future consideration of covert action.

In addition to the major covert action case studies, the Committee spent five months investigating alleged plots to assassinate foreign leaders. This inquiry led, inevitably, into covert action writ large. Plots to assassinate Castro could not be understood unless seen in the context of Operation MONGOOSE, a massive covert action program designed to "get rid of Castro." The death of General Schneider in Chile could not be understood unless seen in the context of what was known as Track II—a covert action program, undertaken by the CIA at the direction of President Nixon, to prevent Salvador Allende from assuming the office of President of Chile. During the assassination inquiry, the Committee heard from over 75 witnesses during 60 days of hearings.

The Committee has chosen not to make public the details of all the covert action case studies, with the exceptions noted above. The force of the Committee's recommendations on covert action might be strengthened by using detailed illustrations of what the United States did under what circumstances and with what results in country "X" or "Y." The purpose of the Committee in examining these cases, however, was to understand the scope, techniques, utility, and propriety of covert action in order to make recommendations for the future. The Committee concluded that it was not essential to expose past covert relationships of foreign political, labor and cultural leaders with the United States Government nor to violate the confidentiality of these relationships. Therefore, names of individuals and institutions have been omitted.

In addition, the Committee decided, following objections raised by the CIA, not to publicly release two sections of this Report—"Techniques of Covert Action" and "Covert Action Projects: Initiation, Review, and Approval." These two sections will be submitted to the Members of the Senate in a classified form. However, for a discussion of covert action techniques, as they were practiced in Chile, see the Committee Staff Report, "Covert Action in Chile: 1963-1973" (pp. 6-10, 14-40).

A. EVOLUTION OF COVERT ACTION

Covert action was not included as one of the charter missions of the CIA. The National Security Act of 1947 (which established the Agency and the National Security Council) does not specifically mention or authorize secret operations of any kind, whether for intelligence collection or covert action.⁵ The 1947 Act does, however, contain a provision which directs the CIA to "perform such other functions and duties related to intelligence affecting the national security as the

⁴ Senate Select Committee, Hearings, 12/4-5/75, Vol. 7.

⁵ See Appendix I, "Congressional Authority for the CIA to Conduct Covert Actions."

National Security Council may from time to time direct." ⁶ One of the drafters of the 1947 Act, former Secretary of Defense Clark Clifford, has referred to this provision as the "catch-all" clause. According to Mr. Clifford:

Because those of us who were assigned to this task and had the drafting responsibility were dealing with a new subject with practically no precedents, it was decided that the Act creating the Central Intelligence Agency should contain a "catch-all" clause to provide for unforeseen contingencies. Thus, it was written that the CIA should "perform such other functions and duties related to intelligence affecting the national security as the National Security Council may from time to time direct." It was under this clause that, early in the operation of the 1947 Act, covert activities were authorized. I recall that such activities took place in 1948 and it is even possible that some planning took place in late 1947. It was the original concept that covert activities undertaken under the Act were to be carefully limited and controlled. You will note that the language of the Act provides that this catch-all clause is applicable only in the event that the national security is affected. This was considered to be an important limiting and restricting clause.⁷

Beginning in December 1947, the National Security Council issued a series of classified directives specifying and expanding the CIA's covert mission.⁸ The first of these directives, NSC-4-A, authorized the Director of Central Intelligence (DCI) to conduct covert psychological operations consistent with United States policy and in coordination with the Departments of State and Defense.

A later directive, NSC 10/2, authorized the CIA to conduct covert political and paramilitary operations. To organize and direct these activities, a semi-independent Office of Policy Coordination (OPC) was established within the CIA. OPC took policy direction from the Departments of State and Defense.⁹ The directive establishing OPC referred to the "vicious covert activities of the U.S.S.R." and authorized the OPC to plan and conduct covert operations, including covert political, psychological, and economic warfare. These early activities were directed against the Soviet threat. They included countering Soviet propaganda and covert Soviet support of labor unions and student groups in Western Europe, direct U.S. support of foreign political parties, "economic warfare," sabotage, assistance to refugee liberation groups, and support of anti-Communist groups in occupied or threatened areas.

Until a reorganization in June, 1950, OPC's responsibilities for paramilitary action were limited, at least in theory, to contingency planning. Networks of agents were trained to assist the escape of re-

⁶ 50 U.S.C. 403(d) (5).

⁷ Clifford, 12/5/75, Hearings, pp. 50-51.

⁸ For a full discussion of the National Security Council and its direction of intelligence activities, see Chapter IV, "The President's Office."

⁹ The semi-independent status of OPC within the CIA created a rivalry with the existing CIA component responsible for clandestine intelligence, the Office of Strategic Operations.

sistance forces and carry out sabotage behind enemy lines in the event of war. However, OPC did conduct some guerrilla-type operations in this early period against Soviet bloc countries, using neighboring countries as bases and employing a variety of "black" activities.¹⁰

The size and activities of the OPC grew dramatically. Many covert action programs initiated in the first few years as an adjunct to the United States policy of communist containment in Europe eventually developed into large-scale and long-term operations, such as the clandestine propaganda radios aimed at the Soviet bloc—Radio Free Europe and Radio Liberty.

Many early OPC activities involved subsidies to European "counterfront" labor and political organizations. These were intended to serve as alternatives to Soviet- or communist-inspired groups. Extensive OPC labor, media, and election operations in Western Europe in the late 1940's, for instance, were designed to undercut debilitating strikes by communist trade unions and election advances by communist parties. Support for "counterfront" organizations, especially in the areas of student, labor and cultural activities, was to become much more prevalent in the 1950s and 1960s, although they later became international rather than European-oriented.

Communist aggression in the Far East led the United States into war in Korea in June 1950. At the same time, Defense Department pressure shifted the focus of OPC activities toward more aggressive responses to Soviet and Chinese Communist threats, particularly military incursions. Large amounts of money were spent for guerrilla and propaganda operations. These operations were designed to support the United States military mission in Korea. Most of these diversionary paramilitary operations never came to fruition. For example, during this period the CIA's Office of Procurement acquired some \$152 million worth of foreign weapons and ammunition for use by guerrilla forces that never came into existence.

As a result of the upsurge of paramilitary action and contingency planning, OPC's manpower almost trebled during the first year of the Korean War. A large part of this increase consisted of paramilitary experts, who were later to be instrumental in CIA paramilitary operations in the Bay of Pigs, the Congo, and Laos, among others. In support of paramilitary activities the CIA had bases and facilities in the United States, Europe, the Mediterranean and the Pacific. OPC's increased activity was not limited to paramilitary operations, however. By 1953, there were major covert operations in 48 countries, consisting primarily of propaganda and political action.

Another event in 1950 affected the development and organizational framework for covert action. General Walter Bedell Smith became CIA Director. He decided to merge OPC with the CIA's Office of Special Operations.¹¹ Although the merger was not completed until

¹⁰ "Black" activities are those intended to give the impression that they are sponsored by an indigenous opposition force or a hostile power, rather than by the United States.

¹¹ In order to accomplish the merger, Smith first consolidated the OPC chain of command by ordering the Director of OPC to report directly to the DCI instead of through the Departments of State and Defense. Smith also appointed his own senior representatives to field stations to coordinate the covert activities of the OPC and the espionage operations of the OSO. The two offices were often competing for the same potential assets in foreign countries.

1954, the most important organizational step took place in August 1952—a single new directorate, entirely within the structure and control of the CIA, was established. Known as the Directorate for Plans (DDP),¹² this new directorate was headed by a Deputy Director and was assigned responsibility for all CIA covert action and espionage functions. The CIA's "Clandestine Service" was now in place.

By the time the DDP was organized, OPC had a large staff and an annual budget of almost \$200 million. It dominated the smaller and bureaucratically weaker OSO in size, glamour, and attention. Yet, one of the original purposes of the merger, according to General Smith, was to protect the OSO function of clandestine intelligence collection from becoming subordinate to the covert action function of OPC. In 1952, Smith wrote that the merger was:

designed to create a single overseas clandestine service, while at the same time preserving the integrity of the long-range espionage and counterespionage mission of the CIA from amalgamation into those clandestine activities which are subject to short-term variations in the prosecution of the Cold War.

Despite Smith's desires, the Cold War, and the "hot war" in Korea, increased the standing, and influence, of the covert "operators" within the CIA. This trend continued throughout the 1950s and 1960s.

The post-Korean War period did not see a reduction in CIA covert activities. Indeed, the communist threat was now seen to be world-wide, rather than concentrated on the borders of the Soviet Union and mainland China. In response, the CIA, at the direction of the National Security Council, expanded its European and crisis-oriented approach into a world-wide effort to anticipate and meet communist aggression, often with techniques equal to those of the Soviet clandestine services. This new world-wide approach was reflected in a 1955 National Security Council Directive which authorized the CIA to:

- Create and exploit problems for International Communism;
- Discredit International Communism, and reduce the strength of its parties and organization;
- Reduce International Communist control over any areas of the world.

The 1950s saw an expansion of communist interest in the Third World. Attempts to anticipate and meet the communist threat there proved to be an easier task than carrying out clandestine activities in the closed Soviet and Chinese societies. Political action projects in the Third World increased dramatically. Financial support was provided to parties, candidates, and incumbent leaders of almost every political persuasion, except the extreme left and right. The immediate purpose of these projects was to encourage political stability, and thus prevent Communist incursions; but another important objective of political action was the acquisition of "agents of influence" who could be used at a future date to provide intelligence or to carry out political action. Through such projects, the CIA developed a world-wide in-

¹²The name was changed to the Directorate for Operations (DDO) in 1973.

frastucture of individual agents, or networks of agents, engaged in a variety of covert activities.

By 1955, the CIA's Clandestine Service had gone through a number of reorganizations. It emerged with a structure for the support of covert action that remained essentially the same until the early 1960s. The Clandestine Service consisted of seven geographic divisions and a number of functional staffs—foreign intelligence, counterintelligence, technical support for covert action, and planning and program coordination. With the demise of paramilitary activities following the Korean War, the Paramilitary Operations Staff had been abolished and its functions merged with the staff responsible for psychological action. An International Organizations Division, created in June 1954, handled all programs in support of labor, youth, student, and cultural counterfront organizations.

Using the covert action budget as one measure of activity, the scope of political and psychological action during the 1950s was greatest in the Far East, Western Europe, and the Middle East, with steadily increasing activity in the Western Hemisphere. The international labor, student, and media projects of the International Organizations Division constituted the greatest single concentration of covert political and propaganda activities. Paramilitary action began to increase again in the late 1950s with large-scale operations in two Asian countries and increased covert military assistance to a third.¹³

The Bay of Pigs disaster in 1961 prompted a reorganization of CIA covert action and the procedures governing it. A new form of covert action—counterinsurgency—was now emphasized. Under the direction of the National Security Council, the CIA rapidly expanded its counterinsurgency capability, focusing on Latin America, Africa, and the Far East. After the Geneva agreements of 1962, the CIA took over the training and advising of the Meo army, previously a responsibility of U.S. military advisers. The Laos operation eventually became the largest paramilitary effort in post-war history. In 1962 the Agency also began a small paramilitary program in Vietnam. Even after the United States Military Assistance Command (MACV) took over paramilitary programs in Vietnam at the end of 1963, the CIA continued to assist the U.S. military's covert activities against North Vietnam.

The CIA's paramilitary effort continued to expand throughout the decade. The paramilitary budget reached an all-time high in 1970. It probably would have continued to climb, had not the burden of the Laos program been transferred to the Department of Defense in 1971.¹⁴

¹³ In 1962 a paramilitary office was reconstituted in the CIA. Following the Bay of Pigs, a panel headed by Lyman Kirkpatrick, then the CIA's Executive Director-Comptroller, recommended that an office be created in the Clandestine Service to centralize and professionalize paramilitary action and contingency planning, drawing upon Agency-wide resources for large-scale operations. As a result, a new paramilitary division was established. It was to operate under the guidance of a new NSC approval group—the Special Group (Counterinsurgency).

¹⁴ Part of the Agency's interest in paramilitary activities stemmed from the Agency's view that these activities are interdependent with intelligence collection functions. DCI John McCone protested the transfer of paramilitary programs in Vietnam to MACV in 1963-1964 because he thought that a third of the intelligence reporting of the CIA's Vietnam station might be lost with such a reduction of CIA participation.

Paramilitary action was but one of the CIA's collection of tools during the early and middle 1960s. Outside the Far East the CIA mounted an increasing number of political, propaganda, and economic projects. This was the era of Operation MONGOOSE, a massive covert assault on the Castro regime in Cuba.¹⁵ The need to combat the "export of revolution" by communist powers stimulated a variety of new covert techniques aimed at an increasingly broad range of "targets." Covert action reached its peak in the years 1964 to 1967.

In contrast to the period 1964 to 1967, when expenditures for political and propaganda action increased almost 60 percent, the period 1968 to the present has registered declines in every functional and geographic category of covert action—except for paramilitary operations in the Far East which did not drop until 1972. The number of individual covert action projects dropped by 50 percent from fiscal year 1964 (when they reached an all-time high) to fiscal year 1968. The number of projects by itself is not an adequate measure of the scope of covert action. Projects can vary considerably in size, cost, duration, and effect. Today, for example, one-fourth of the current covert action projects are relatively high-cost (over \$100,000 annually).

No matter which standards are used, covert activities have decreased considerably since their peak period in the mid- and late 1960s. Recent trends reflect this decrease in covert action. In one country, covert activities began in the early years of the OPC and became so extensive in the 1950s and 1960s that they affected almost every element of that society. A retrenchment began in 1965; by 1974 there were only two relatively small-scale political action projects. The only covert expenditure projected for fiscal year 1976 is a small sum for the development of potential "assets" or local agents who may be used for covert action in the future. In a second country, covert action expenditures in 1975 were less than one percent of the total in 1971. A slight increase was projected for fiscal year 1976, also for the development of potential assets for future use. The CIA has thus curtailed its covert action projects in these two countries, although its current investment in potential assets indicates that the Agency does not want to preclude the possibility of covert involvement in the future.

Some of the major reasons for the decline of covert activities since the mid- and late 1960s include:

- a reduction of CIA labor, student, and media projects following the 1967 *Ramparts* disclosure and the subsequent recommendations of the Katzenbach Committee;

- the transfer of covert military assistance in Laos from the CIA budget to the Defense Department budget in 1971, and the termination of many other covert activities in that area with the end of the war in Indochina in 1975;

- reductions in overseas personnel of the Clandestine Service as a result of studies and cuts made by James Schlesinger, first when he was with the Office of Management and Budget and later during his brief tenure as Director of Central Intelligence in 1973;

¹⁵ Senate Select Committee, "Alleged Assassination Plots Involving Foreign Leaders," p. 130 ff.

—shifting U.S. foreign policy priorities in the 1970s, which have de-emphasized sustained involvement in the internal affairs of other nations; and

—concern among Agency officials and U.S. policymakers that publicity given to CIA covert activities would increase the chances of disclosure and generally decrease the chances of success of the kinds of large-scale, high-expenditure projects that developed in the 1960s.^{15a}

B. CONGRESSIONAL OVERSIGHT

There is no reference to covert action in the 1947 National Security Act, nor is there any evidence in the debates, committee reports, or legislative history of the 1947 Act to show that Congress intended specifically to authorize covert operations.¹⁶ Since the CIA's wartime predecessor, the Office of Strategic Services, had conducted covert operations, Congress may have anticipated that these operations were envisioned.

Whether specifically authorized by Congress or not, CIA covert operations were soon underway. Citing the "such other functions and duties" clause of the 1947 Act as authority, the National Security Council authorized the CIA to undertake covert operations at its first meeting in December 1947. At that point Congress became responsible for overseeing these activities.

Shortly after the passage of the 1947 Act, the Armed Services and Appropriations Committees of the House and the Senate assumed jurisdiction for CIA activities and appropriations. In the Senate, following an informal arrangement worked out with Senators Vandenberg and Russell, small CIA subcommittees were created within Armed Services and Appropriations. Over time, the relations between the subcommittees and the CIA came to be dominated by two principles: "need to know" and "want to know."¹⁷ The "want to know" principle was best expressed in a statement made in 1956 by a congressional overseer of the CIA, Senator Leverett Saltonstall:

It is not a question of reluctance on the part of CIA officials to speak to us. Instead, it is a question of our reluctance, if you will, to seek information and knowledge on subjects which I personally, as a member of Congress and as a citizen, would rather not have, unless I believed it to be my responsibility to have it because it might involve the lives of American citizens.¹⁸

^{15a} The next two sections of this report "Covert Action Techniques" and "Covert Action Projects: Initiation, Review, and Approval," remain classified after consultation between the Committee and the executive branch. See p. 143.

¹⁶ For a full discussion of the statutory authority for CIA activities, and congressional authorization of covert action, see Chapter VII and Appendix I.

¹⁷ The Rockefeller Commission made a similar point in its Report:

"In sum, congressional oversight of the CIA has been curtailed by the secrecy shrouding its activities and budget. At least until quite recently, Congress has not sought substantial amounts of information. Correspondingly, the CIA has not generally volunteered additional information." (Report of the Commission on CIA Activities Within the United States, 6/6/75, p. 77.)

¹⁸ Congressional Record—April 9, 1956, p. 8,5202.

From the beginning, the House and the Senate subcommittees were relatively inactive. According to information available to the Select Committee, the Senate Armed Services subcommittee met 26 times between January 1966 and December 1975. The subcommittee met five times in 1975, twice in 1974, once in 1973 and 1972, and not at all in 1971.

Relations between the CIA and the subcommittees came to be determined, in large part, by the personal relationship between the chairmen and the CIA Director, often to the exclusion of other subcommittee members. Staff assistance was minimal, usually consisting of no more than one professional staff member.

The two Senate subcommittees had somewhat different responsibilities.¹⁹ The Appropriations subcommittee was to concentrate on the budgetary aspects of CIA activities. The Armed Services subcommittee had the narrower responsibility of determining the legislative needs of the Agency and recommending additional or corrective legislation. It did not authorize the CIA's annual budget.

The CIA subcommittees received general information about some covert operations. Prior to the Hughes-Ryan Amendment to the 1974 Foreign Assistance Act, however, the subcommittees were not notified of these operations on any regular basis. Notifications occurred on the basis of informal agreements between the CIA and the subcommittee chairmen.²⁰ CIA covert action briefings did not include detailed descriptions of the methods and cost of individual covert action projects. Rather, projects were grouped into broad, general programs, either on a country-wide basis or by type of activity, for presentation to the subcommittees.

Chile can serve as an example of how oversight of covert action was conducted. According to CIA records, there was a total of 53 congressional briefings on Chile by the CIA between April 1964 and December 1974. At 33 of these meetings there was some discussion of covert action; special releases of funds for covert action from the Contingency Reserve were discussed at 23 of them. Of the 33 covert action briefings, 20 took place prior to 1973, and 13 took place after.²¹

Of the 33 covert action projects undertaken in Chile between 1963 and 1974 with 40 Committee approval, Congress was briefed in some fashion on eight. Presumably the 25 others were undertaken without congressional consultation.²² Of the more than \$13 million spent in Chile on covert action projects between 1963 and 1974, Congress

¹⁹ Initially the Armed Services and Appropriations subcommittees met separately. However, in the 1960s, because of overlapping membership the two committees met jointly. For several years Senator Richard Russell was chairman of both subcommittees.

²⁰ In 1967, the House and Senate CIA appropriations subcommittees began receiving notifications of withdrawals from the CIA's Contingency Reserve Fund within 48 hours of the release. In 1975 the two Armed Service subcommittees began receiving the same notifications, at the initiative of Director Colby.

²¹ The 13 briefings which occurred after 1973 (March 1973 to December 1974) included meetings with the Senate Foreign Relations Subcommittee on Multinational Corporations and the House Foreign Affairs Subcommittee on Inter-American Affairs. All these meetings were concerned with *past* CIA covert action in Chile.

²² Among the 25 projects were a \$1.2 million authorization in 1971, half of which was spent to purchase radio stations and newspapers while the other half went to support municipal candidates in anti-Allende political parties; and an additional expenditure of \$815,000 in late 1971 to provide support to opposition political parties in Chile.

received briefings (sometimes before and sometimes after the fact) on projects totaling about \$9.3 million. Further, congressional oversight committees were not consulted about projects which were not reviewed by the full 40 Committee. One of these was the Track II attempt by the CIA, at the instruction of President Nixon, to prevent Salvador Allende from taking office in 1970.²³

Congressional oversight of CIA covert operations was altered as a result of the Hughes-Ryan amendment to the 1974 Foreign Assistance Act. That amendment stated:

Sec. 662. Limitation on Intelligence Activities.—(a) No funds appropriated under the authority of this or any other Act may be expended by or on behalf of the Central Intelligence Agency for operations in foreign countries, other than activities intended solely for obtaining necessary intelligence, unless and until the President finds that each such operation is important to the national security of the United States and reports, in a timely fashion, a description and scope of such operation to the appropriate committees of the Congress, including the Committee on Foreign Relations of the United States Senate and the Committee on Foreign Affairs of the United States House of Representatives.²⁴

The Hughes-Ryan amendment had two results. First, it established *by statute* a reporting requirement to Congress on covert action. Second, the amendment increased the number of committees that would be informed of approved covert operations. The inclusion of the Senate Foreign Relations Committee and the House International Relations Committee was in recognition of the significant foreign policy implications of covert operations.

Despite these changes, the oversight role of Congress with respect to covert operations is still limited. The law does not require notification of Congress before covert operations are implemented. The DCI has not felt obligated to inform the subcommittees of approved covert action operations prior to their implementation, although in some cases he has done so. Problems thus arise if members of Congress object to a decision by the President to undertake a covert operation.

The recent case of Angola is a good example of the weaknesses of the Hughes-Ryan amendment. In this case, the Executive fully complied with the requirements of the amendment. In January 1975 the administration decided to provide substantial covert political support to the FNLA faction in Angola.²⁵ In early February, senior mem-

²³ With respect to congressional oversight of CIA activities in Chile, the Committee's Staff report on "Covert Action in Chile" concluded:

"Between April 1964 and December 1974, CIA's consultation with its congressional oversight committees—and thus Congress' exercise of its oversight function—was inadequate. The CIA did not volunteer detailed information; Congress most often did not seek it." (Senate Select Committee, "Covert Action in Chile," p. 40.)

²⁴ 22 USC 2422.

²⁵ There were three factions involved in the Angolan conflict: the National Front for the Liberation of Angola (FNLA), led by Holden Roberto; the National Union for the Total Independence of Angola (UNITA), led by Jonas Savimbi; and the Popular Movement for the Liberation of Angola, (MPLA) led by Agostinho Neto. The latter group received military and political support from the Soviet Union and Cuba.

bers of the six congressional committees received notification of this decision.

In late July the 40 Committee and President Ford approved an additional expenditure to provide covert military assistance to the FNLA and a second Angolan faction, UNITA. Again senior members of the six committees were notified. The Chairman, the ranking minority member, and Chief of Staff of the Senate Foreign Relations Committee were briefed in late July. Under procedures established within that committee, a notice of the CIA briefing was circulated to all committee members. When Senator Dick Clark, Chairman of the Foreign Relations Subcommittee on African Affairs, learned that the covert action program was in Africa, he requested further details. On July 28, Clark's subcommittee was briefed on the paramilitary assistance program to the FNLA and, apparently, some members of the subcommittee objected.

In early September the Administration decided to increase its covert military assistance to Angola by \$10.7 million, bringing the total amount to \$25 million. Again, the required notifications were carried out.²⁶

In early November, Senator Clark raised his objections to the Angola operation before the full Senate Foreign Relations Committee. The Committee in turn asked Director Colby and Secretary Kissinger to testify, in closed session, on U.S. involvement in Angola. At this meeting, several members of the Committee expressed their concern for the program to Director Colby and Undersecretary Joseph Sisco, who represented the State Department in Secretary Kissinger's absence. Despite this concern, in mid-November President Ford and the 40 Committee authorized the expenditure of another \$7 million for covert military assistance to Angola. In early December, the congressional committees were notified of this new infusion of military assistance.

Finding opposition within the briefing mechanism ineffective, Senator Clark proposed an amendment to a pending military and security assistance bill. In January 1976 after a complicated series of legislative actions, additional covert military assistance to Angola was prohibited by Congress by an amendment to the Defense appropriations bill.

The dispute over Angola illustrates the dilemma Congress faces with respect to covert operations. The Hughes-Ryan amendment guaranteed information about covert action in Angola, but not any control over this controversial instrument of foreign policy. Congress had to resort to the power of the purse to express its judgment and will.

C. FINDINGS AND CONCLUSIONS ^{26a}

Covert action has been a tool of United States foreign policy for the past 28 years. Thousands of covert action projects

²⁶ On September 25, 1975 the *New York Times* first reported the fact of U.S. covert assistance to the FNLA and UNITA. The article stated that Director Colby had notified Congress of the Angola operation in accordance with the Hughes-Ryan amendment, but "no serious objections were raised." There was little reaction to the *Times* article, either in Congress or by the public.

^{26a} See Appendix II which presents summaries of recommendations regarding covert action made to the Senate Select Committee during the course of its investigation.

have been undertaken. An extensive record has been established on which to base judgments of whether covert action should have a role in the foreign policy of a democratic society and, if so, under what restraints of accountability and control. The Committee's examination of covert action has led to the following findings and conclusions.

1. The Use of Covert Action

Although not a specific charter mission of the Central Intelligence Agency, covert action quickly became a primary activity. Covert action projects were first designed to counter the Soviet threat in Europe and were, at least initially, a limited and ad hoc response to an exceptional threat to American security. Covert action soon became a routine program of influencing governments and covertly exercising power—involving literally hundreds of projects each year. By 1953 there were major covert operations underway in 48 countries, consisting of propaganda, paramilitary and political action projects. By the 1960s, covert action had come to mean "any clandestine activity designed to influence foreign governments, events, organizations or persons in support of United States foreign policy." Several thousand individual covert action projects have been undertaken since 1961, although the majority of these have been low-risk, low-cost projects, such as a routine press placement or the development of an "agent of influence."

That covert action was not intended to become a pervasive foreign policy tool is evident in the testimony of those who were involved in the drafting of the 1947 National Security Act. One of these drafters, Clark Clifford, had this to say about the transition of covert action from an ad hoc response to a frequently used foreign policy tool:

It was the original concept that covert activities undertaken under the Act were to be carefully limited and controlled. You will note that the language of the Act provides that this catch-all clause is applicable only in the event that national security is affected.²⁸ This was considered to be an important limiting and restricting clause.

However, as the Cold War continued and Communist aggression became the major problem of the day, our Government felt that it was necessary to increase our country's responsibilities in protecting freedom in various parts of the world. It seems apparent now that we also greatly increased our covert activities. I have read somewhere that as time progressed we had literally hundreds of such operations going on simultaneously. It seems clear that these operations have gotten out of hand.²⁹

²⁸ The CIA, under the 1947 Act, is directed "to perform such other functions and duties related to intelligence affecting the national security as the National Security Council may from time to time direct."

²⁹ Clifford, 12/5/75, Hearings, p. 51.

2. Covert Action "Success" and "Failure"

The record of covert action reviewed by the Committee suggests that net judgments as to "success" or "failure" are difficult to draw.³⁰ The Committee has found that when covert operations have been consistent with, and in tactical support of, policies which have emerged from a national debate and the established processes of government, these operations have tended to be a success. Covert support to beleaguered democrats in Western Europe in the late 1940s was in support of an established policy based on a strong national consensus. On the other hand, the public has neither understood nor accepted the covert harassment of the democratically elected Allende government. Recent covert intervention in Angola preceded, and indeed preempted, public and congressional debate on America's foreign policy interest in the future of Angola. The intervention in Angola was conducted in the absence of efforts on the part of the executive branch to develop a national consensus on America's interests in Southern Africa.

The Committee has received extensive testimony that covert action can be a success when the objective of the project is to support an individual, a party, or a government in doing what that individual, party, or government wants to do—and when it has the will and capacity to do it. Covert action cannot build political institutions where there is no local political will to have them. Where this has been attempted, success has been problematical at best, and the risks of exposure enormously high.

The Committee's findings on paramilitary activities suggest that these operations are an anomaly, if not an aberration, of covert action.³¹ Paramilitary operations are among the most costly and controversial forms of covert action. They are difficult, if not impossible, to conceal. They lie in the critical gray area between limited influence, short of the use of force, and overt military intervention. As such, paramilitary activities are especially significant. In Vietnam, paramilitary strategy formed a bridge between the two levels of involvement. Paramilitary operations have great potential for escalating into major military commitments.

Covert U.S. paramilitary programs have generally been designed to accomplish one of the following objectives: (1) subversion of a hostile government (e.g., Cuba); (2) support to friendly governments

³⁰ Former Attorney General and Under Secretary of State Nicholas Katzenbach had this to say about covert action "success" and "failure":

"I start from the premise that some of our covert activities abroad have been successful, valuable in support of a foreign policy which was understood and approved by the electorate and Congress . . . I also start from a premise that some of our activities abroad have not been successful, and have been wrong and wrongheaded. In some cases we have grossly over-estimated our capacity to bring about a desired result and have created situations unintended and undesirable." (Nicholas Katzenbach testimony, House Select Committee on Intelligence, 12/10/75, Hearings, Vol. 5, p. 1707.)

³¹ The Committee studied, in detail, covert military operations in five countries, including Laos, Vietnam, and Angola. The Committee analyzed paramilitary programs in terms of (1) executive command and control; (2) secrecy and deniability; (3) effectiveness; (4) propriety; and (5) legislative oversight. The latter issue is vital because paramilitary operations are directly related to, and pose special problems for, Congress' authority and responsibilities in making war.

(Laos); (3) unconventional adjunct support to a larger war effort (Korea, Vietnam, Laos after the middle 1960s).

There are two principal criteria which determine the minimum success of paramilitary operations: (1) achievement of the policy goal; and (2) maintenance of deniability. If the first is not accomplished, the operation is a failure in any case; if the second is not accomplished, the paramilitary option offers few if any advantages over the option of overt military intervention. On balance, in these terms, the evidence points toward the failure of paramilitary activity as a technique of covert action.³²

Of the five paramilitary activities studied by the Committee, only one appears to have achieved its objectives. The goal of supporting a central government was achieved—the same government is still in power many years later. There were a few sporadic reports of the operation in the press, but it was never fully revealed nor confirmed.

In no paramilitary case studied by the Committee was complete secrecy successfully preserved. All of the operations were reported in the American press to varying extents, while they were going on. They remained deniable only to the extent that such reports were tentative, sketchy, and unconfirmed, and hence were not necessarily considered accurate.

3. The Impact of Covert Action

Assessing the "success" or "failure" of covert action is necessary. Just as important, however, is an assessment of the impact of covert action on "targeted" nations and the reputation of the United States abroad.

The impact of a large-scale covert operation, such as Operation MONDOOSE in Cuba, is apparent. Less apparent is the impact of small covert projects on "targeted" countries. The Committee has found that these small projects can, in the aggregate, have a powerful effect upon vulnerable societies.

In some cases, covert support has encouraged a debilitating dependence on the United States. In one Western nation the covert investment was so heavy and so persistent that, according to a former CIA Station Chief in that country:

Any aspiring politician almost automatically would come to CIA to see if we could help him get elected. . . . They were the wards of the United States, and that whatever happened for good or bad was the fault of the United States.

Cyrus Vance, a former Deputy Secretary of Defense, cited another such example:

Paramilitary operations are perhaps unique in that it is more difficult to withdraw from them, once started, than covert

³² For example, the covert paramilitary program in Laos certainly ceased to be plausibly deniable as soon as it was revealed officially in the 1969 Symington hearings of the Senate Foreign Relations Committee (it was revealed unofficially even earlier). If U.S. policy was the preservation of a non-communist Laotian government, the program obviously failed. Some administration witnesses, nevertheless, including DCI Colby, cited the war in Laos as a great success. Their reasoning was based on the view that the limited effort in Laos served to put pressure on North Vietnamese supply lines, and therefore was a helpful adjunct of the larger U.S. effort in Vietnam.

operations. This is well illustrated by the case of the Congo, where a decision was taken to withdraw in early 1966, and it took about a year and a half before the operation was terminated. Once a paramilitary operation is commenced, the recipient of the paramilitary aid tends to become dependent upon it and inevitably advances the argument that to cut back or terminate the aid would do the recipient great damage. This makes it especially difficult to disengage.³⁴

In other cases, covert support to foreign political leaders, parties, labor unions, or the media has made them vulnerable to repudiation in their own society when their covert ties are exposed. In Chile, several of the Chilean nationals who had been involved in the CIA's anti-Allende "spoiling" operation had to leave the country when he was confirmed as President.

In addition, the history of covert action indicates that the cumulative effect of hidden intervention in the society and institutions of a foreign nation has often not only transcended the actual threat, but it has also limited the foreign policy options available to the United States Government by creating ties to groups and causes that the United States cannot renounce without revealing the earlier covert action.

The Committee also found that the cumulative effects of covert action are rarely noted by the operational divisions of the CIA in the presentation of new projects or taken into account by the responsible National Security Council review levels.

The Committee has found that certain covert operations have been incompatible with American principles and ideals and, when exposed, have resulted in damaging this nation's ability to exercise moral and ethical leadership throughout the world. The U.S. involvement in assassination plots against foreign leaders and the attempt to foment a military coup in Chile in 1970 against a democratically elected government were two examples of such failures in purposes and ideals. Further, because of widespread exposure of covert operations and suspicion that others are taking place, the CIA is blamed for virtually every foreign internal crisis.

4. The Executive's Use of Covert Action

In its consideration of covert action, the Committee was struck by the basic tension—if not incompatibility—of covert operations and the demands of a constitutional system. Secrecy is essential to covert operations; secrecy can, however, become a source of power, a barrier to serious policy debate within government, and a means of circumventing the established checks and procedures of government. The Committee found that secrecy and compartmentation contributed to a temptation on the part of the Executive to resort to covert operations in order to avoid bureaucratic, congressional, and public debate. In addition, the Committee found that the major successes of covert action tended to encourage the Executive to press for the use of covert action as the easy way to do things and to task the CIA with difficult requirements, such as running a large-scale "secret" war in Laos or

³⁴ Cyrus Vance testimony, 12/5/75, Hearings, Vol. 7, p. 85, footnote.

attempting to overturn the results of a national election in Chile—within a five-week period.

The Committee found that the Executive has used the CIA to conduct covert operations because it is less accountable than other government agencies. In this regard, Secretary of State Henry Kissinger told the Committee:

I do not believe in retrospect that it was good national policy to have the CIA conduct the war in Laos. I think we should have found some other way of doing it. And to use the CIA simply because it is less accountable for very visible major operations is poor national policy. And the covert activities should be confined to those matters that clearly fall into a gray area between overt military action and diplomatic activities, and not to be used simply for the convenience of the executive branch and its accountability.³⁵

Under questioning, Secretary Kissinger went on to say that in Laos there were two basic reasons why the CIA was used to fight that war: "one, to avoid a formal avowal of American participation there for diplomatic reasons, and the second, I suspect, because it was less accountable."³⁶

The Committee has found that the temptation of the Executive to use covert action as a "convenience" and as a substitute for publicly accountable policies has been strengthened by the hesitancy of the Congress to use its powers to oversee covert action by the CIA. Much of this hesitancy flowed from the legitimate desire on the part of congressional oversight committees to maintain the security of covert action projects. But it also resulted from a reluctance on the part of the appropriate committees to challenge the President or to become directly involved in projects perceived to be necessary for the national security. Congressional hesitancy also flowed from the fact that congressional oversight committees are almost totally dependent on the Executive for information on covert operations. The secrecy needed for these operations allows the Executive to justify the limited provision of information to the Congress.

5. Maintaining a Covert Capability

Former senior government officials have testified to their concern that the use and control of covert action is made more difficult by a strong activism on the part of CIA operational officers. McGeorge Bundy, a former Special Assistant for National Security Affairs to Presidents Kennedy and Johnson, has stated:

While in principle it has always been the understanding of senior government officials outside the CIA that no covert operations would be undertaken without the explicit approval of "higher authority," there has also been a general expectation within the Agency that it was its proper business to generate attractive proposals and to stretch them, in operation, to the furthest limit of any authorization actually received.³⁷

³⁵ Henry Kissinger testimony, 11/21/75, p. 54.

³⁶ *Ibid.*, p. 58.

³⁷ McGeorge Bundy testimony, House Select Committee on Intelligence, 12/10/75, Hearings, Vol. 5, pp. 1794-1795.

Clark Clifford, in testimony before the Select Committee, reinforced this view:

On a number of occasions a plan for covert action has been presented to the NSC and authority requested for the CIA to proceed from point A to point B. The authority will be given and the action will be launched. When point B is reached, the persons in charge feel that it is necessary to go to point C and they assume that the original authorization gives them such a right. From point C, they go to D, and possibly E, and even further. This led to some bizarre results, and, when investigation is started, the excuse blandly presented that the authority was obtained from the NSC before the project was launched.³⁸

The activism referred to by Bundy and Clifford is reflected in part, in the maintenance of a standing covert action capability and a worldwide "infrastructure." The Committee found that one of the most troublesome and controversial issues it confronted in evaluating covert action was the question of the utility and propriety of the CIA's maintaining a worldwide "infrastructure" (e.g., agents of influence, assets, and media contacts). Are these "assets" essential to the success of a major covert action program? Or does this standby capability generate a temptation to intervene covertly as an alternative to diplomacy?

There is no question that the CIA attaches great importance to the maintenance of a worldwide clandestine infrastructure—the so-called "plumbing"—in place. During the 1960s the Agency developed a worldwide system of standby covert action "assets," ranging from media personnel to individuals said to influence the behavior of governments.³⁹ In recent years, however, the Agency has substantially reduced its overseas covert action infrastructure even to the point of closing bases and stations. A limited infrastructure is still maintained, however. For example, although the United States has no substantial covert action program in the Western Hemisphere today, the CIA does continue to maintain a modest covert action infrastructure consisting of agents of influence and media contacts.

The CIA's infrastructure is constructed in response to annual Operating Directives. These directives set station priorities for both clandestine collection and covert action.⁴⁰ The Operating Directives are developed and issued by the CIA and informally coordinated with concerned CIA geographic bureaus and the Department of State. Therefore, the infrastructure that is in place at any given time is there at the direction of the CIA.

The Committee finds several troublesome problems with the CIA's development and maintenance of covert action infrastructures

³⁸ Clark M. Clifford testimony 12/5/75, Hearings, Vol. 7, pp. 51-52.

³⁹ During its assassination inquiry, the Committee found that certain CIA assets, with the cryptonyms QJ/WIN, WI/ROGUE and AM/LASH were involved, or contemplated for use in, plots to assassinate foreign leaders.

⁴⁰ For example, the Chilean Operating Directive for FY 1972 directed the Santiago Station to: "Sponsor a program which will enable the Chilean armed forces to retain their integrity and independent political power. Provide direct financial support to key military figures who can be expected to develop a meaningful following in their respective services to restrain and, perhaps, topple the Allende government." The Select Committee found no evidence to indicate that this "direct financial support" was provided.

throughout the world: (1) The operating decisions are made by the CIA, although infrastructure guidelines are cleared with the State Department; the Agency's Operating Directives are rarely seen outside the CIA and (2) the actual covert action projects which build and maintain these infrastructures rarely, if ever, go to the NSC for approval.

The Committee finds that the independent issuance of Operating Directives, and the fact that most covert action projects which establish and maintain the CIA's infrastructure around the world do not go to the NSC, combine to shield this important clandestine system from effective policy control and guidance. The Committee believes that all small so-called "non-sensitive" projects which do not now go to the NSC level for approval should, at a minimum, be aggregated into appropriate country or regional programs, and then brought to the NSC level for approval.

Covert action should be the servant of policy. Secretary Kissinger made this point before the Committee when he testified:

If the diplomatic track cannot succeed without the covert track, then the covert track was unnecessary and should not have been engaged in. So hopefully, if one wants to draw a general conclusion, one would have to say that only those covert actions can be justified that support a diplomatic track.⁴¹

6. Conclusions

Given the open and democratic assumptions on which our government is based, the Committee gave serious consideration to proposing a total ban on *all* forms of covert action. The Committee has concluded, however, that the United States should maintain the option of reacting in the future to a grave, unforeseen threat to United States national security through covert means.

The Hughes-Ryan amendment to the 1974 Foreign Assistance Act restricts the CIA from undertaking "operations in foreign countries, other than activities intended for obtaining necessary intelligence, unless and until the President finds that each such operation is important to the national security of the United States."⁴² The Committee has concluded that an even stricter standard for the use of covert action is required than the injunction that such operations be "important to the national security of the United States."

The Committee's review of covert action has underscored the necessity for a thoroughgoing strengthening of the Executive's internal review process for covert action and for the establishment of a realistic system of accountability, both within the Executive, and to the Congress and to the American people. The requirement for a rigorous and credible system of control and accountability is complicated, however, by the shield of secrecy which must necessarily be imposed on any covert activity if it is to remain covert. The challenge is to find a substitute for the public scrutiny through congressional debate and press attention that normally attends government decisions. In its consideration of the present processes of authorization and review, the Committee has found the following:

⁴¹ Henry Kissinger testimony, 11/21/75, p. 38.

⁴² See p. 151, for full text of Hughes-Ryan amendment.

(1) The most basic conclusion reached by the Committee is that covert action must be seen as an exceptional act, to be undertaken only when the national security requires it and when overt means will not suffice. The Committee concludes that the policy and procedural barriers are presently inadequate to insure that any covert operation is absolutely essential to the national security. These barriers must be tightened and raised or covert action should be abandoned as an instrument of foreign policy.

(2) On the basis of the record, the Committee has concluded that covert action must in no case be a vehicle for clandestinely undertaking actions incompatible with American principles. The Committee has already moved to condemn assassinations and to recommend a statute to forbid such activity. It is the Committee's view that the standards to acceptable covert activity should also exclude covert operations in an attempt to subvert democratic governments or provide support for police or other internal security forces which engage in the systematic violation of human rights.

(3) Covert operations must be based on a careful and systematic analysis of a given situation, possible alternative outcome, the threat to American interests of these possible outcomes, and above all, the likely consequences of an attempt to intervene. A former senior intelligence analyst told the Committee:

Clearly actions were taken on the basis of some premises, but they seem not to have been arrived at by any sober and systematic analysis, and tended often, it appeared, to be simplistic and passionate. In fact, there was often little or no relationship between the view of world politics as a whole, or of particular situations of threat held by operators on the one hand, and analysts on the other. The latter were rarely consulted by the former, and then only in partial disingenuous and even misleading ways.

It says something strange about successive DCIs that they allowed this bifurcation, even contradiction, to obtain.⁴³

The Committee has concluded that bringing the analysts directly into the *formal* decision process would be a partial remedy to the problem of relating analysis to operations. More important would be the insistence of the Director of Central Intelligence that the political premises of any proposed covert operation be rigorously analyzed.

(4) The Committee also concludes that the appropriate NSC committee (e.g., the Operations Advisory Group) should review *every* covert action proposal. The Committee also holds strongly to the view

⁴³ John Huzenga testimony, 1/20/76, pp. 6-7. The Committee found, in its case study of Chile, that there was little or no coordination between the intelligence analysts and the covert operators, especially in politically sensitive projects, which were often restricted within the Clandestine Service and the 40 Committee. The project files for Chile gave no indication of consultation with the Intelligence Directorate from 1964 to 1973. The exclusion of expert analytic advice extended to the DCI's staff responsible for preparing National Intelligence Estimates. Today, however, the Deputy Director for Intelligence (DDI) is informed by the DDO of new covert activities. The DDI has an opportunity to comment on them and offer recommendations to the DCI, but he is not in the formal approval process.

that the small nonsensitive covert action proposals which, in the aggregate, establish and maintain the Agency's covert infrastructure around the world should be considered and analyzed by the appropriate NSC committee. The Committee also believes that many of the small covert action proposals for projects would fall away when forced to meet the test of being part of a larger covert action operation in support of the openly avowed policies of the United States.

(5) With respect to congressional oversight of covert action, the Committee believes that the appropriate oversight committee should be informed of all significant covert operations *prior* to their initiation and that all covert action projects should be reviewed by the committee on a semi-annual basis. Further, the oversight committee should require that the annual budget submission for covert action programs be specific and detailed as to the activity recommended. Unforeseen covert action projects should be funded only from the Contingency Reserve Fund which could be replenished only after the concurrence of the oversight and any other appropriate congressional committees. The legislative intelligence oversight committee should be notified prior to any withdrawal from the Contingency Reserve Fund.

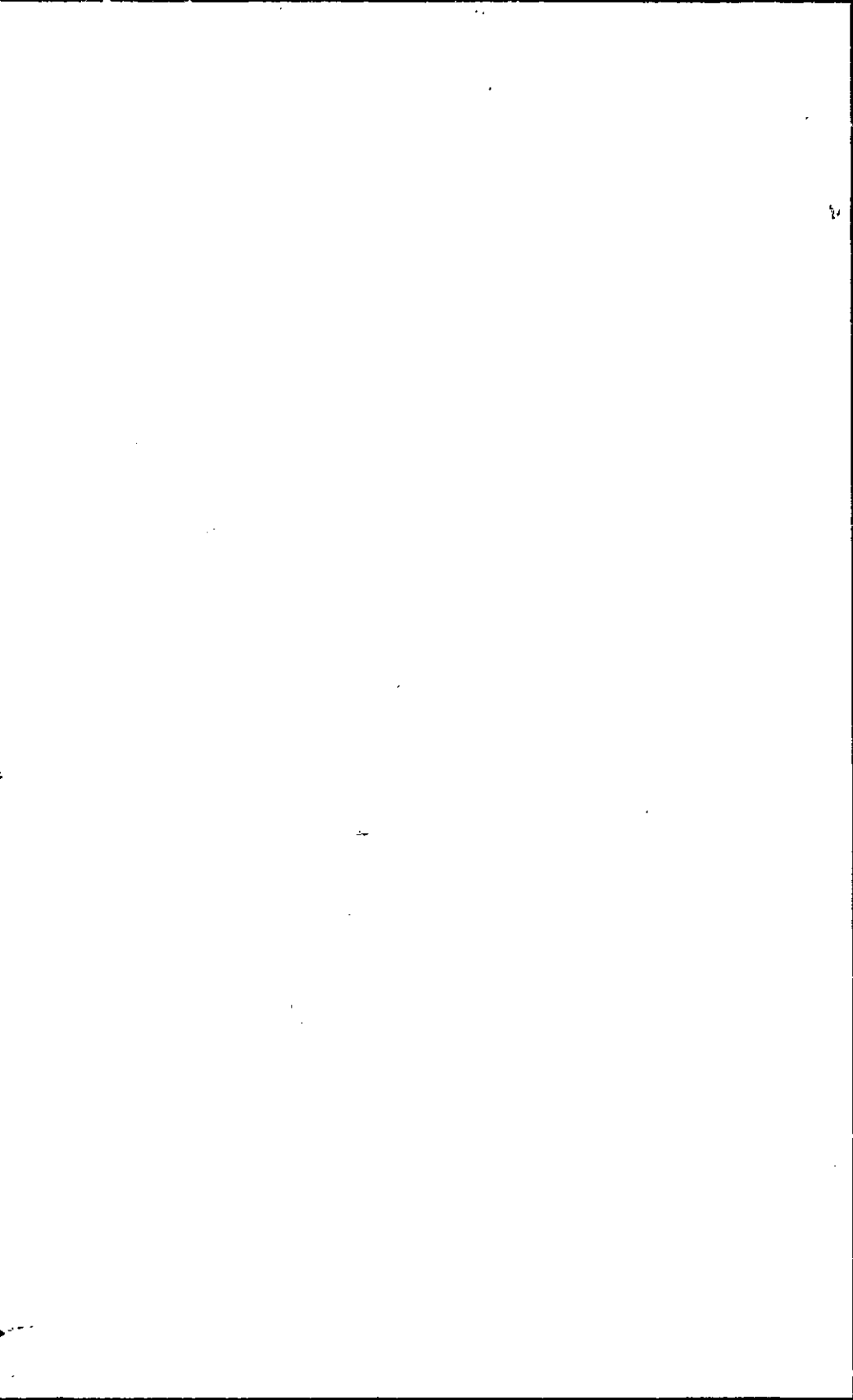

IX. CIA COUNTERINTELLIGENCE

A. COUNTERINTELLIGENCE: AN INTRODUCTION

1. Definition of Counterintelligence

Counterintelligence (CI) is a special form of intelligence activity, separate and distinct from other disciplines. Its purpose is to discover hostile foreign intelligence operations and destroy their effectiveness. This objective involves the protection of the United State Government against infiltration by foreign agents, as well as the control and manipulation of adversary intelligence operations. An effort is made to both discern and deceive the plans and intentions of enemy intelligence services. Defined more formally, counterintelligence is an intelligence activity dedicated to undermining the effectiveness of hostile intelligence services. Its purpose is to guard the nation against espionage, other modern forms of spying, and sabotage directed against the United States, its citizens, information, and installations, at home and abroad, by infiltrating groups engaged in these practices and by gathering, storing, and analyzing information on inimical clandestine activity.¹

In short, counterintelligence specialists wage nothing less than a secret war against antagonistic intelligence services. "In the absence of an effective U.S. counterintelligence program," notes a counterintelligence specialist, "[adversaries of democracy] function in what is largely a benign environment."²

2. The Threat

The adversaries of democracy are numerous and widespread. In the United States alone, 1,079 Soviet officials were on permanent assignment in February 1975, according to FBI figures.³ Among these, over 40 percent have been positively identified as members of the KGB or GRU, the Soviet civilian and military intelligence units. Conservative estimates for the number of unidentified intelligence officers raise the figures to over 60 percent of the Soviet representation; some defector sources have estimated that 70 percent to 80 percent of Soviet officials have some intelligence connection.⁴

Furthermore, the number of Soviets in the United States has tripled since 1960, and is still increasing.⁵ The opening of American deep-water ports to Russian ships in 1972 has given Soviet intelligence

¹ Counterintelligence may also be thought of as the knowledge needed for the protection and preservation of the military, economic, and productive strength of the United States, including the security of the Government in domestic and foreign affairs against or from espionage, sabotage, and all other similar clandestine activities designed to weaken or destroy the United States. (Report of the Commission on Government Security Washington, D.C., 1957, pp. 48-49.)

² Staff summary of interview, FBI counterintelligence specialist, 5/8/75.

³ Staff summary of interview, FBI counterintelligence specialist, 3/10/75.

⁴ FBI counterintelligence specialist (staff summary), 3/10/75.

⁵ FBI counterintelligence specialist (staff summary), 5/8/75.

services "virtually complete geographic access to the United States," observes a counterintelligence specialist.⁶ In 1974, for example, over 200 Soviet ships with a total crew complement of 13,000 officers and men called at 40 deep-water ports in this country.

Various exchange groups provide additional opportunities for Soviet intelligence gathering within the United States. Some 4,000 Soviets entered the United States as commercial or exchange visitors in 1974. During the past decade, the FBI identified over 100 intelligence officers among the approximately 400 Soviet students who attended American universities during this period as part of an East-West student exchange program.⁷ Also, in the 14-year history of this program, more than 100 American students were the target of Soviet recruitment approaches in the USSR.

Other areas of counterintelligence concern include the sharp increase in the number of Soviet immigrants to the United States (less than 500 in 1972 compared to 4,000 in 1974); the rise in East-West commercial exchange visitors (from 641 in 1972 to 1,500 in 1974); and the growing number of Soviet bloc officials in this country (from 416 in 1960 to 798 in 1975).⁸

Foreign intelligence agents have attempted to recruit not only executive branch personnel, but also Congressional staff members. The FBI has advised the Committee that there have been instances in the past where hostile foreign intelligence officers have used the opportunity presented by overt contacts to attempt to recruit members of Congressional staffs who might have access to secret information.^{8a}

The most serious threat is from "illegal" agents who have no easily detectable contacts with their intelligence service. The problem of "illegals" is summarized by the FBI as follows:

The illegal is a highly trained specialist in espionage tradecraft. He may be a [foreign] national and/or a professional intelligence officer dispatched to the United States under a false identity. Some illegals [may be] trained in the scientific and technical field to permit easy access to sensitive areas of employment.

The detection of . . . illegals presents a most serious problem to the FBI. Once they enter the United States with either fraudulent or true documentation, their presence is obscured among the thousands of legitimate emigres entering the United States annually. Relatively undetected, they are able to maintain contact with [the foreign control] by means of secret writing, microdots, and open signals in conventional communications which are not susceptible to discovery through conventional investigative measures.^{8b}

⁶ *Ibid.*

⁷ *Ibid.*, 3/10/75.

⁸ *Ibid.*

^{8a} FBI Memorandum for the Record, 10/30/75. Such recruitment approaches have been reported to the FBI by Congressional staff members. If the FBI otherwise learns of such recruitments, its policy is to report the facts to the appropriate Members of Congress.

^{8b} FBI memorandum, "Intelligence Activities Within the United States by Foreign Governments," 3/20/75.

In several instances the FBI accomplished this most difficult assignment by carefully designed and limited mail opening programs which, if they had been authorized by a judicial warrant, might have been entirely proper. It is most unfortunate that the FBI did not choose to seek lawful authorization for such methods.^{8c}

This brief summary of the threat facing the American counterintelligence corps in this country is troubling enough, yet it does not take into account the worldwide scope of the problem. As an FBI counterintelligence expert states, hostile foreign intelligence services

are alert for operational opportunities against the United States whether they occur within this country, abroad (in other countries) or in the home country itself. An operation might begin in the home country with recruitment of an American visitor; transfer to the United States with his return; and again, even later, might be transferred to a third country where the American agent may be met outside the normal reach of United States counterintelligence coverage. Regardless of the geographical location, the operation is still directed against the United States and can cause just as much damage from abroad as within our own borders.⁹

The espionage activities of the Soviet Union and other communist nations directed against the United States are extensive and relentless.^{9a}

To combat this threat, American counterintelligence officers have developed various sophisticated investigative techniques to (1) obtain information about foreign intelligence services, (2) protect our intelligence service, and (3) control the outcome of this subterranean struggle for intelligence supremacy. The task is difficult technically, and raises sensitive legal and ethical questions. As the CIA Deputy Director for Operations has testified, the

U.S. counterintelligence program to be both effective and in line with traditional American freedoms must steer a middle course between blanket, illegal, frivolous and unsubstantiated inquiries into the private lives of U.S. citizens and excessive restrictions which will render the Government's counterintelligence arms impotent to protect the nation from foreign penetration and covert manipulation.¹⁰

3. CI as Product: Information about "The Enemy"

Counterintelligence is both an activity and its product. The product is reliable information about all the hostile foreign intelligence services who attack the United States by stealth. To guard against hostile intelligence operations aimed at this nation, a vast amount of information is required. It is necessary to know the organizational structure of the enemy service, the key personnel, the methods of recruitment and training, and the specific operations.

This information must be gathered within the United States and in all the foreign areas to which U.S. interests extend. Within the intelli-

^{8c} Testimony of W. R. Wannall, Assistant Director, FBI, 10/21/75, p. 5; see Report on CIA and FBI Mail Opening.

⁹ FBI Counterintelligence specialist (staff summary), 3/10/75.

^{9a} See Appendix III, Soviet Intelligence Collection and Operations Against the United States.

¹⁰ William Nelson testimony, 1/28/76, p. 5.

gence service, this acquisitive activity is referred to as intelligence collection. The resulting product—pertinent information on the enemy intelligence service—is often called “raw” intelligence data. The efforts of intelligence services through the world to conceal such information from one another, through various security devices and elaborate deceptions, creates the counterintelligence specialist what James Angleton, former Chief of CIA Counterintelligence, calls a kind of “wilder-ness of mirrors.”

4. *CI as Activity: Security and Counterespionage*

As an activity, CI consists of two matching halves: security and counter espionage. *Security* is the passive or defensive, side of counter-intelligence. It consists basically of establishing static defenses against all hostile and concealed acts, regardless of who carries them out.

Counterespionage (CE) is the offensive, or aggressive, side of counter-intelligence. It involves the identification of a specific adversary and a knowledge of the specific operation he is conducting. Counterespionage personnel must then attempt to counter these operations by infiltrating the hostile service (called penetration) and through various forms of manipulation. Ideally, the thrust of the hostile operation is turned back against the enemy.

The security side of counterintelligence includes the screening and clearance of personnel and the development of programs to safeguard sensitive intelligence information (that is, the proper administration of security controls). The intelligence services try to defend three things: (1) their personnel, (2) their installations, and (3) their operations.

At the Central Intelligence Agency, the Office of Security is responsible for protection of personnel and installations, while actual operations are largely the preserve of the CI staff and the operating divisions. Among the defensive devices used for *information control* by intelligence agencies throughout the world are: security clearances, polygraphs, locking containers, security education, document accountability, censorship, camouflage, and codes. Devices for *physical security* include fences, lighting, general systems, alarms, badges and passes, and watchdogs. *Area control* relies on curfews, checkpoints, restricted areas, and border-frontier control.¹² Thus the security side of counterintelligence “is all that concerns perimeter defense, badges, knowing everything you have to know about your own people;” the counterespionage side “involves knowing all about intelligence services—foreign intelligence services—their people, their installations, their methods, and their operations. So that you have a completely different level of interest.”¹³ However, the Office of Security and the CI staff exchange information to assure adequate security systems.

5. *The Penetration and the Double Agent*

Several kinds of operations exist within the rubric of counterespionage. One, however, transcends all the others in importance: the penetration. A primary goal of counterintelligence is to contain the intelligence service of the enemy. To do so, it is eminently desirable to

¹² Staff summary of interview, CIA security specialist, 8/20/75.

¹³ Raymond Rocca deposition, 11/25/75, p. 10.

know his plans in advance and in detail. This admirable, but difficult, objective may be achieved through a high-level infiltration of the opposition service. As a Director of the CIA has written, "Experience has shown penetration to be the most effective response to Soviet and Bloc [intelligence] services."¹⁴

Moreover, a well-placed infiltrator in a hostile intelligence service may be better able than anyone else to determine whether one's own service has been penetrated. A former Director of the Defense Intelligence Agency (DIA) has observed that the three principal programs used by the United States to meet, neutralize, and defeat hostile intelligence penetrations are: (1) our own penetrations; (2) security screening and clearance of personnel; and (3) our efforts for safeguarding sensitive intelligence information.¹⁵ The importance of the penetration is emphasized by an experienced CIA counterespionage operative, with mixed but expressive similes: "Conducting counterespionage with penetration can be like shooting fish in a barrel;" in contrast, "conducting counterespionage without the act of penetration is like fighting in the dark."¹⁶

Methods of infiltrating the opposition service take several forms. Usually the most effective and desirable penetration is the recruitment of an agent-in-place.¹⁷ He is a citizen of an enemy nation and is already in the employ of its intelligence service. Ideally, he will be both highly placed and venal. The individual, say a KGB officer in Bonn, is approached and asked to work for the intelligence service of the United States. Various inducements—including ideology—may be used to recruit him against his own service. If the recruitment is successful, the operation may be especially worthwhile since the agent is presumably already trusted within his organization and his access to documents may be unquestioned. Jack E. Dunlap, who worked at and spied on the National Security Agency (NSA) in the 1960s, is a well-known example of a Soviet agent-in-place within the U.S. intelligence service. His handler was a Soviet Air Force attaché at the Soviet Embassy in Washington. Of course, a single penetration can be worth an intelligence gold mine, as were Kim Philby for the Soviet Union and Col. Oleg Penkovsky for the United States.

Another method of infiltration is the double agent. Double agents, however, are costly and time-consuming, and they are risky. Human lives are at stake. Double agents also normally involve pure drudgery, with few dramatic results, as new information is checked against existing files. On top of this comes the difficulty of assuring against a doublecross.

Moreover, passing credible documents can be a major problem. The operations must be made interesting to the opposition. To make fake papers plausible, the genuine article must be provided now and again. Classified documents must be cleared, and this process can be

¹⁴ Memorandum from John McCone to Chairman, President's Foreign Intelligence Advisory Board, 10/8/63.

¹⁵ The Carroll Report on the Dunlap Case, 2/12/64.

¹⁶ CIA/CI specialist, staff summary, 11/1/75.

¹⁷ CIA/CI specialist, staff summary, 10/17/75.

painstakingly slow. Also, "this means letting a lot of good stuff go to the enemy without much in return," complains a CI officer with considerable experience.¹⁸

To accomplish each of these tasks, hard work, careful planning, and considerable manpower are necessary. The extraordinary manpower requirements of the double agent operation restricted the abilities of the British to run cases during the Second World War—approximately 150 double agents for the entire period of the war and no more than about 25 at any one time.¹⁹ Moreover, their mission was eased greatly by the ability of the British to read the German cipher throughout most of the conflict.

6. *The Defector*

Almost as good as the agent-in-place and less troublesome than the whole range of double agents is the "defector with knowledge." Here the procedure consists of interrogation and validation of bona fides, as usual, but without the worrisome, ongoing requirements for a skillful mix of false and genuine documents and other logistical support. Though an agent-in-place is preferable because of the continuing useful information he can provide, often a man does not want to risk his life by staying in-place, especially where the security is sophisticated; his preference is to defect to safety. In other words, agents-in-place are harder to come by in systems like the Soviet bloc countries; defection is more likely.²⁰ In contrast, agents-in-place are more easily recruited in so-called Third World areas.

Within the United States, the interrogation of intelligence service defectors who have defected in the U.S. is primarily the responsibility of the FBI, though the CIA may have a follow-up session with the individual. Sometimes the bona fides of a defector remain disputed for many years.

CIA-recruited defectors abroad are occasionally brought to the United States and resettled. The FBI is notified and, after the CIA completes its interrogation, FBI may interrogate. CIA does not bring all defectors to the United States; only those expected to make a significant contribution. CIA generally handles resettlement not only of defectors from abroad, but also (at the request of the FBI) of defectors in the United States.

7. *The Deception*

The penetration or double agent is closely related to another important CE technique: the deception. Simply stated, the deception is an attempt to give the enemy a false impression about something, causing him to take action contrary to his own interests. Fooling the Germans into the belief that D Day landings were to be in the Pas de Calais rather than in Normandy is a classic example of a successful deception operation in World War II.²¹

¹⁸ Rocca deposition, 11/25/75, pp. 33-34.

¹⁹ Sir John Masterman, *Double Cross System of the War of 1939-45* (New Haven: Yale University Press, 1972).

²⁰ Bruce Solie, deposition, 11/25/75, pp. 20-27.

²¹ Masterman, *Double Cross System*.

Deception is related to penetration because our agents operating within foreign intelligence agencies can serve as excellent channels through which misleading information can go to the enemy. So double agents serve both as collectors of positive intelligence and channels for deception. However, there are opportunities for deception other than our own agents; in fact, "an infinite variety" exists, according to an experienced practitioner.²³ One example: the U.S. can allow penetration of its own intelligence service, and then feed false information through him.

8. Other CI Techniques

Other counterespionage operations include surreptitious surveillance of various kinds (for instance, audio, mail, physical, and "optical"—that is, photography), interrogation (sometimes incommunicado as in the case of one defector), and provocation. Decoding clandestine radio transmission and letters with messages written in secret ink between the visible lines is part and parcel of the CE trade, as is trailing suspected agents, observing "dead drops" (the exchange of material, like documents or instructions, between a spy and his handler), and photographing individuals entering opposition embassies or at other locations. At the recent funeral of CIA agent Richard Welch, two Eastern European diplomats were discovered among the press corps snapping photographs of CIA intelligence officers attending the burial ceremony.²⁴ Since the focus of offensive counterintelligence is disruption of the enemy service, provocation can be an important element of CE, too. It amounts, in essence, to harassment of the opposition, such as publishing the names of his agents or sending a defector into his midst who is in reality a double agent.

9. CI as Organization

Security at CIA is the responsibility of the Office of Security, a division of the Deputy Director for Administration. Counterespionage policy is guided by the Counterintelligence Staff of the Operations Directorate (Clandestine Service). Besides setting policy, the CI Staff sometimes conducts its own operations, though most CI operations emanate directly from the various geographic divisions as the CI field personnel—through the practice of the counterintelligence discipline—attempt to guard against enemy manipulation of espionage and covert action operations.

Structurally, counterintelligence services are usually composed of two additional sections which support Security and Operations. They are the Research and the Liaison sections. Good research is critical to a good counterintelligence effort, and it may take several forms. It can involve the amassing of encyclopedic intelligence on individuals, including American citizens associated—wittingly or unwittingly—with hostile intelligence services. Specialists say that the hallmark of a sophisticated CI service is its collection of accurate records.²⁵ CI research personnel also produce reports on topics of interest to the specialty, including guidelines for the interrogation of defectors and current analyses on such subjects as proprietary companies used by

²³ CIA counterintelligence specialist (staff summary), 11/1/75.

²⁴ CIA counterintelligence specialist (staff summary), 1/15/70.

²⁵ 6/27/76.

²⁶ *Ibid.*, 6/27/76.

foreign intelligence services and the structure of Soviet bloc intelligence services. CI researchers also analyze defector briefs and, in the case of compromised documents, help ascertain who had access and what damage was inflicted.

Liaison with other counterintelligence services, at home and abroad, is also vital since no effective counterintelligence organization can do its job alone. The various CI units at home are particularly important, as counterintelligence—with all its intricacies and deceptions—requires coordination among agencies and sharing of records. Unlike the totally unified KGB organization, the American intelligence service is fragmented and depends upon liaison to make operations more effective. Coordination between CIA and FBI counterintelligence units is especially critical since, in theory at least, the former has foreign jurisdiction and the latter domestic, yet they must monitor the movements of foreign spies in and out of these two jurisdictions. Sometimes this coordination fails dramatically. In 1970, for example, J. Edgar Hoover of the FBI terminated formal liaison with the CIA and all the other intelligence units in the Government because of a disagreement with the CIA on a question of source disclosure (the Thomas Riha case).²⁶

Liaison with foreign intelligence services overseas can undergo strain, too. As one CI specialist has said: "There are no friendly services; there are services of friendly foreign powers."²⁷ Each service fears the other has been infiltrated by hostile agents and is reluctant to see national secrets go outside its own vaults. Nonetheless, cooperation does take place, since all intelligence services seek information and, with precautions, will take it where they can get it if it is useful.

The CIA will work with friendly services to uncover hostile intelligence operations, including illegals, directed at the government of the friendly service. For example, a CIA-recruited defector may reveal Soviet agents in a friendly foreign government. This information is shared with the friendly government, if there is proper protection of the source. Protection of the CIA source is paramount.

FBI counterespionage activities within the United States are supervised by the Counterintelligence Branch of the FBI Intelligence Division. The Branch is made up of four Sections, three of which direct field operations conducted by the Bureau's field offices. The fourth handles liaison with other agencies and supervises the FBI's Legal Attaches assigned to serve in the embassies in several foreign countries.

The formal structure for counterespionage coordination between the FBI and the military intelligence agencies was established in 1939 and embodied most recently in a "charter" for the Interdepartmental Intelligence Conference in 1964.^{27a} This formal body, chaired by the FBI Director and including the heads of the military intelligence agencies, has not played a significant decisionmaking role in recent years.

²⁶ Staff summary of interview, former FBI liaison person with CIA, 8/22/75.

²⁷ Rocca deposition, 11/25/75, p. 43.

^{27a} Confidential memorandum from President Roosevelt to Department Heads, 6/26/39; memorandum from Attorney General Kennedy to J. Edgar Hoover, Chairman, Interdepartmental Intelligence Conference, 3/5/64.

As late as 1974, some FBI officials took the position that the Bureau's counterespionage activities were not under the authority of the Attorney General, since the FBI was accountable in this area directly to the United States Intelligence Board and the National Security Council. A Justice Department committee chaired by Assistant Attorney General Henry Petersen sharply rejected this view and declared:

There can be no doubt that in the area of foreign counter-intelligence, as in all its other functions, the FBI is subject to the power and authority of the Attorney General.^{27b}

In recent years the FBI has taken steps to upgrade its counterespionage effort, which had been neglected because of the higher priority given to domestic intelligence in the late 60s and early 70s.^c New career development and mid-career training programs have been instituted. FBI agents specializing in counterespionage begin their careers as criminal investigators and not as analysts; and Bureau officials stress that their role is accurate fact-finding, rather than evaluation. Nevertheless, counterespionage supervisory personnel have recently attended high-level training courses in foreign affairs and area studies outside the Bureau.^{27d}

Here, then, are the key elements of counterintelligence. Together they combine into a discipline of great importance, for the rock bottom obligation of an intelligence service is to defend the country; meeting this obligation is the very *raison d'être* of counterintelligence. The discipline also represents the most secret of secret intelligence activities—the heart of the onion. Its great importance and its ultra secrecy make counterintelligence an area of concern that cannot be ignored by policymakers and by those responsible for legislative oversight. As a review of current issues in CI attests, the discipline has several problems which demand the attention of those charged with the defense of the country and the reform of the intelligence community.

B. CURRENT ISSUES IN COUNTERINTELLIGENCE

1. *Two Philosophies*

December 1974 marked the end of an era in CIA counterintelligence. James Angleton, the Chief of Counterintelligence at the Central Intelligence Agency since 1954, retired over differences of opinion with Director William Colby on the proper approach to the practice of counterintelligence.

The new regime proved to be considerably different in its approach to counterintelligence, emphasizing a diffusion of CI responsibility.

^{27b} Report of the Petersen Committee on COINTELPRO, pp. 34-35. The committee was especially concerned that the *ad hoc* equivalent of the U.S. Intelligence Board had approved the discredited "Huston Plan" in 1970. However, the committee complied with the FBI's request that it exclude from its review of domestic COINTELPRO activities the Bureau's "extremely sensitive foreign intelligence collection techniques." (Memorandum from FBI Director Kelley to Acting Attorney General Robert Bork, 12/11/73.)

^{27c} C. D. Brennan testimony, Hearings, Vol. 2, p. 117.

^{27d} W. R. Wannall testimony, 1/21/76, pp. 18-22.

ties throughout the Operations Directorate. Presumably, this has led to an increased flow of counterintelligence information within the Agency but, at the same time, has raised questions concerning compartmentation and security.

The new Chief of CIA Counterintelligence has instituted a series of specific changes which have been studied closely by the Select Committee. The findings are of an extremely sensitive character and have been reported to the Senate and to the President in a classified form. It should be noted here that CIA counterintelligence is now emphasizing different factors than heretofore, which reflect a somewhat different philosophy than that espoused by Angleton. These differences in viewpoint raise several important questions concerning how best to protect the United States, including the proper degree of compartmentation of CI information, methods of operation, approaches to security, research priorities, extent of liaison cooperation, and emphasis on deception activities, among other things.

A high-level executive branch review of the classified issues which have surfaced in this disagreement is of considerable importance. Included in this review should be an examination of the approval process for certain counterespionage operations.

2. Interagency Relations

Equally as troubling as these issues is the problem of CIA/CI relations with other counterintelligence units in the Government. Particularly vexing have been the on-again off-again liaison ties between the Agency and the FBI.²⁸ This history has been marked by turbulence, though a strong undercurrent of cooperation has usually existed at the staff level since 1952 (when the Bureau began sending a liaison man to the CIA on a regular basis). The sources of friction between the CIA and the FBI in the early days revolved around such matters as the frequent unwillingness of the Bureau to assist the CIA within the United States or to help recruit foreign officials in this country. Pressure from the CIA on the Bureau to increase microphone coverage of foreign targets within the United States was also a "red flag" to Hoover.²⁹

A series of such disagreements punctuated the relations between the two agencies throughout the 1950s and 1960s. Several flaps arose, for example, when the CIA Domestic Operations Division attempted to recruit foreign officials within the United States and failed to advise the Bureau.³⁰

In 1966 an informal agreement was negotiated between the FBI and the CIA to regularize their "coordination." This agreement had as its "heart" that the CIA would "seek concurrence and coordination of the FBI" before engaging in clandestine activity in the United States, and that the FBI would "concur and coordinate if the proposed action does not conflict with any operation, current or planned, including active investigation [by] the FBI." Moreover, when an agent recruited by the CIA abroad arrived in the United States, the FBI would "be advised" and the two agencies would "confer regarding the handling

²⁸ Former FBI liaison person with CIA (staff summary), 8/22/75.

²⁹ *Ibid.*

³⁰ *Ibid.*

of the agent in the United States." The CIA could "continue" its "handling" of the agent for "foreign intelligence" purposes; and the FBI would also become involved where there were "internal security factors," although it was recognized that CIA might continue to "handle" the agent in the United States and provide the Bureau with "information" bearing on "internal security matters."^{30a}

Eventually, the much heralded (though actually minor) Riha incident in 1970 became "the straw that broke the camel's back."³¹ Hoover ordered the discontinuation of FBI liaison with the Central Intelligence Agency. Though informal means of communication continued between CIA and FBI staff personnel, Hoover's decision was a setback to the coordination of counterintelligence activities in the Government. Not until Hoover was gone from the Bureau did formal liaison relations begin to improve.³²

Today, most counterintelligence officers in both agencies say that coordination and communication linkages are good, though a recently retired CIA/CI officer points to "a vital need for closer integration of the CI efforts of the CIA and the FBI."³³ The most salient criticisms of FBI counterintelligence voiced at the CIA concern (1) the lack of sufficient CI manpower in the FBI; (2) occasional disputes over the bona fides of defectors; and, (3) differences of opinion on the possibility of hostile penetrations within the Government. Each of these matters also requires immediate review by the executive branch. In particular, the occasional interagency disputes over defector bona fides and differences of opinion on suspected hostile penetrations cry out for a higher level of authority in the executive branch to settle these sometimes divisive disagreements.

3. *The Scope and Basis of FBI Counterintelligence*

In the imperfect contemporary world where other nations have interests which conflict with those of the United States, foreign-directed clandestine intelligence activities in this country must be of constant concern to the American people. One of the original reasons for the FBI's domestic intelligence mission was that the United States needed in the late 1930s a coordinated program for investigating "persons engaged in espionage, counter-espionage or sabotage."³⁴ By mid-1939 the FBI and military intelligence had gathered a "reservoir of information concerning foreign agencies operating in the United States" with efficient "channels for the exchange of information."³⁵ There is no question that during this prewar period, foreign espionage constituted a serious threat to the security of the United States and thus supported the basic decision to conduct investigations of activities which were "not within the specific provisions of prevailing statutes"³⁶

^{30a} Testimony of former FBI liaison person with CIA, 9/22/75, pp. 52-55.

³¹ James Angleton testimony, 9/24/75, Hearings, pp. 657-58.

³² Scott Miller testimony, the Commission on CIA Activities Within the United States, 3/19/75, p. 938.

³³ Statement from Scott Miler to the Senate Select Committee, 1/28/76, pp. 32-33.

³⁴ Memorandum from J. Edgar Hoover to Attorney General Murphy, 3/16/39.

³⁵ Letter from Attorney General Murphy to President Roosevelt, 6/17/39.

³⁶ Memorandum from Hoover to Murphy, 3/16/39.

but which involved "potential" espionage, counterespionage, or sabotage.³⁷

One of the major difficulties in any attempt to base investigations of foreign espionage on the criminal statutes has been, from the outset, the restricted and sometimes contradictory scope of the laws. A recent legal analysis has observed that "the legislation is in many ways incomprehensible."³⁸ Most notably, the espionage statutes do not make it a crime simply to engage in the knowing and unauthorized transfer of classified information to foreign agents.³⁹ Moreover, the statutes do not extend to a range of privately held information, especially on scientific and technical matters, which would be valuable to a foreign power.

Hostile foreign intelligence activities include more than just looking for classified information or espionage recruits. Information of a highly technical and strategic nature (though unclassified), which is normally restricted or unavailable in other societies, is openly procurable in the United States through academic institutions, trade associations, and government offices. Intelligence officers may seek out persons who have defected to the United States, to induce them to redefect back to their home country.⁴⁰ Foreign intelligence targets in this country may include information possessed by third nations and their representatives in the United States.

Moreover, the type of activity which is most easy to detect and which may indicate possible espionage does not always satisfy the normal standard of "reasonable suspicion." As a study prepared by the Fund for the Republic stated twenty years ago:

The problems of crime detection in combatting espionage are not ordinary ones. Espionage is a crime which succeeds only by secrecy. Moreover, spies work not for themselves or privately organized crime "syndicates," but as agents of national states. Their activities are therefore likely to be carefully planned, highly organized, and carried on by techniques skillfully designed to prevent detection.⁴¹

Consequently, espionage investigations must be initiated on the basis of fragments of information, especially where there may be only an indication of a suspicious contact with a foreign agent and limited data as to the specific purposes of the contact.

In addition, prosecution is frequently not the objective of an espionage investigation. For one thing, the government may desire "to

³⁷ Directive of President Roosevelt, 8/20/39. While the FBI's responsibilities were also described at times as extending to "subversion," and the lack of outside guidance allowed for overly broad FBI investigations, the problem of spying was always paramount. See the orders of President Roosevelt and Attorney General Biddle regarding warrantless wiretapping, discussed in report on warrantless FBI Electronic Surveillance.

³⁸ Harold Edgar and Benno C. Schmidt, "The Espionage Statutes and Publication of Defense Information," *Columbia Law Review*, Vol. 53, (May, 1973) pp. 929, 934.

³⁹ *Ibid.*, p. 1084.

⁴⁰ FBI Memorandum, "Intelligence Activities Within the United States by Foreign Governments," 3/20/75.

⁴¹ Fund for the Republic, *Digest of the Public Record of Communism in the United States* (New York, 1955), p. 20.

avoid exposing its own counterespionage practices and information."⁴² In addition, the purpose of the investigation may be to find out what a known foreign agent is looking for, both as an indication of the espionage interest of the foreign country and as a means of insuring that the agent is not on the track of vital information. Since foreign agents are replaceable, it may be a better defense not to expel them from the country or otherwise halt their activities, but rather to maintain a constant watch on their operations. This also means investigating in a mere limited fashion many of the Americans with whom the foreign agent associates, in order to determine what the agent may be interested in learning from them.

In the 1930s and 1940s, another argument for going beyond the criminal statutes was that there were significant ideological and nationality factors which motivated persons to engage in espionage. As Attorney General Jackson put it in 1940, individuals were a "likely source" of law violation because they were "sympathetic with the systems or designs of foreign dictators."⁴³ The 1946 Report of the Canadian Royal Commission made similar findings. This was the most persuasive rationale for continuing FBI intelligence investigations of Communists and Fascists, as well as German and other nationality groups, before World War II. It continued to be a substantial basis for such investigations of Communists after the war.⁴⁴

By the mid-fifties, however, the characteristics of foreign espionage had changed substantially. The decline of the Communist Party caused a shrinkage in possible recruits, with the result that Soviet intelligence reverted "more and more . . . to the old type of conventional spy."⁴⁵ A report prepared by the Association of the Bar of the City of New York observed that it was "vital" to adjust the government's security programs to "new conditions," one of which was the "decline of the appeal of Communism." The report added:

In the 1930s and 1940s the Soviet Union could rely on the support of a small but substantial group in this country who were sympathetic with its asserted aims. Now this has largely changed. . . . This has made a radical change in the type and number of persons who might be lured into Communist espionage.⁴⁶

The FBI itself believed that the Communist Party had become a "potential" rather than an actual espionage danger.⁴⁷ While that

⁴² *Ibid.*

⁴³ Proceedings of the Federal-State Conference on Law Enforcement Problems of National Defense, 8/5-6/40.

⁴⁴ "A characteristic of most of the cases in which espionage for the Soviet Union has been prosecuted is that the participants seem to have been motivated by ideology. . . ." Fund for the Republic, Digest of the Public Record of Communism in the United States, p. 20.

⁴⁵ Alexander Dallin, *Soviet Espionage* (New Haven: Yale University Press, 1955), p. 510. This authoritative study of Communist espionage added that "the traditional type of nonpolitical spy has advantages over a Communist: his past evokes no suspicion."

⁴⁶ Report of the Special Committee on the Federal Loyalty-Security Program of the Association of the Bar of the City of New York (New York: Dodd, Mead & Co., 1956), pp. 35-36.

⁴⁷ FBI Monograph, "The Communist Menace in the United States Today," (1955), I (v-v).

potential threat was still significant, in view of the Party's subservience to the Soviet Union, the counterespionage justification for sweeping investigations of persons one or two steps removed from the Party (e.g., "sympathizers" or "infiltrated" groups) lost much of its force.

Nevertheless, there continue to be hostile foreign intelligence activities which the FBI characterizes as "efforts to penetrate the American political system;" or attempts "to develop an agent of influence in American politics" or efforts "to influence the U.S. policy-making structure."⁴⁸

Therefore, the monitoring of contacts between U.S. government officials and foreign officials who are likely to be carrying out the directions of a hostile foreign intelligence service is a necessary part of the FBI's investigative duties. The subject of investigation is the foreign official, and any inquiry directed towards the American official can be limited to determining the nature of the foreign official's interests. Frequently it is desirable that the American official be informed by the Bureau, especially when the contact is overt rather than furtive or clandestine. (The same is also true with respect to overt contacts with American private citizens.)⁴⁹

There are two areas of special difficulty in prescribing the FBI's proper responsibility. The first involves contacts between Members of Congress or high-level executive officials and equally high-level foreign officials. There have been instances where the FBI has had reason to believe that such contacts might involve the unauthorized disclosure of confidential information to a foreign government. Except in such rare circumstances, however, contacts of this nature need not be the subject of FBI investigation or dissemination.⁵⁰

The second difficulty involves the concept "foreign subversion," used most recently in President Ford's Executive Order defining the counterintelligence duties of the U.S. intelligence community, including the FBI.⁵¹ As noted above, the Bureau characterizes certain hostile foreign intelligence activities as attempts to develop "agents of influence in American politics." The FBI considered one of Dr. Martin Luther King's advisors to be such an "agent of influence." In this case, as with the massive investigations to uncover possible foreign "influence" on domestic protest activities, the concern for "foreign subversion" was distorted so far beyond reasonable definition that the term "subversion" should be abandoned completely. Even with the qualifier "foreign," the concept is so elastic as to be susceptible to future misuse.

Nevertheless, there remains a compelling need to investigate *all* the activities of hostile foreign intelligence services, including their efforts to recruit "agents of influence." This can be accomplished by continuing investigation of the foreign agents themselves. Where a foreign

⁴⁸ FBI Memorandum, "Intelligence Activities Within the United States by Foreign Governments," 8/20/75.

⁴⁹ Contacts made secretly or with the apparent intent to avoid detection justify more extensive investigation.

⁵⁰ Where the FBI discovers such contacts as a by-product of its investigations for other purposes, they can be noted without reference to the identity of the U.S. official in order to compile a quantitative measure of foreign activity.

⁵¹ Executive Order 11906, "United States Foreign Intelligence Activities," Sec. 2(a)(2); Sec. 4(b)(4); Sec. 4(g)(1, 2, 11/70).

agent makes an overt contact with an American, a limited inquiry regarding the American is appropriate to determine the nature of the foreign agent's interests. This applies whether the agent's interest is information or "influence," and the Bureau can frequently make its inquiry known to the American. But the Bureau's objectives should be confined solely to learning more about the overall mission of the hostile service and the particular assignments of its officers, as opposed to investigating "influence" by foreign officials or agents who do not have intelligence duties and the lawful activities of Americans who are not foreign agents. There is no compelling reason for intensive investigations of U.S. officials (or private citizens) simply because they are targets of foreign "influence." The line must be tightly drawn so that FBI counter-intelligence investigations do not themselves once again intrude into the American political process, with consequences damaging not only to the rights of Americans, but also to public confidence in the Bureau. Citizen cooperation with the FBI is essential to its success in detecting and countering the threat of hostile foreign intelligence operations to the defense of the nation.

To achieve this end, the federal criminal statutes dealing with espionage should be substantially revised to take account of the contemporary counterintelligence responsibilities of the FBI. A realistic definition of foreign-directed clandestine intelligence activity would make it possible for the FBI to base its counterintelligence investigations on the firm foundation of the criminal law, rather than the shifting interpretations of terms like "subversion" in executive orders. The Committee agrees with Attorney General Edward H. Levi that:

the fact that the FBI has criminal investigative responsibilities, which must be conducted within the confines of constitutional protections strictly enforced by the courts, gives the organization an awareness of the interests of individual liberties that might be missing in an agency devoted solely to intelligence work.²²

C. CONCLUSIONS

1. A Subcommittee on Counterintelligence should be established within the framework of the National Security Council (NSC). Its purpose would be to monitor CI activities, authorize important counterespionage operations, and adjudicate interagency disagreements over CI policies, coordination, defector bona fides, suspected hostile penetrations, and related matters.

2. The President of the United States, in consultation with the oversight committee(s) of Congress, should undertake a top secret review of current issues in the realm of counterintelligence. This review, which should form the basis for an internal Presidential statement on national counterintelligence policy and objectives, should include close attention to the following issues: compartmentation, operations, security, research, accountability, training, internal review, deception, liaison and coordination, and manpower.

3. Congressional oversight should devote more attention to this

²² Levi testimony, 12/10/75, Hearings, Vol. 6, pp. 314-315.

area to help preserve the liberties of American citizens and to prod the intelligence community toward a more effective defense of the nation.

(Additional recommendations on counterintelligence, including reform of the espionage laws and legislation setting standards for activities affecting the rights of Americans, are made in the Committee's Report on Intelligence Activities and the Rights of Americans.)

X. THE DOMESTIC IMPACT OF FOREIGN CLANDESTINE OPERATIONS: THE CIA AND ACADEMIC INSTITUTIONS, THE MEDIA, AND RELIGIOUS INSTITUTIONS

Although its operational arena is outside the United States, CIA clandestine operations make use of American citizens as individuals or through American institutions. Clandestine activities that touch American institutions and individuals have taken many forms and are effected through a wide variety of means: *university officials and professors provide leads and make introductions for intelligence purposes*;¹ scholars and journalists collect intelligence; journalists devise and place propaganda; United States publications provide cover for CIA agents overseas.

These forms of clandestine cooperation had their origins in the early Cold War period when most Americans perceived a real threat of a communist imperium and were prepared to assist their government to counter that threat. As the communists pressed to influence and to control international organizations and movements, mass communications, and cultural institutions, the United States responded by involving American private institutions and individuals in the secret struggle over minds, institutions and ideas. Over time national perceptions would change as to the nature and seriousness of the communist ideological and institutional threat. Time and experience would also give increasing currency to doubts as to whether it made sense for a democracy to resort to practices such as the clandestine use of free American institutions and individuals—practices that tended to blur the very difference between “our” system and “theirs” that these covert programs were designed to preserve.

These covert relationships have attracted public concern and the attention of this Committee because of the importance Americans attach to the independence of private institutions. Americans recognize that insofar as universities, newspapers, and religious groups help mold the beliefs of the public and the policymakers, their diversity and legitimacy must be rigorously protected. It is through them that a society informs and criticizes itself, educates its young, interprets its history, and sets new goals.

At the same time, Americans also recognize the legitimacy and necessity of certain clandestine operations, particularly the collection of foreign intelligence. To conclude that certain sectors of American life must be placed “off limits” to clandestine operations inevitably raises questions not only on possible intelligence losses which would result from such a prohibition, but on whether the United States can

¹ The material italicized in this report has been substantially abridged at the request of the executive agencies. The classified version of this material is available to members of the Senate under the provisions of Senate Resolution 21 and the Standing Rules of the Senate. See also p. IX.

afford to forego the clandestine use of our universities, our media, and our religious groups in competing with our adversaries.

In exploring this problem the Committee has given special attention to the CIA's past clandestine relationships with American institutions. The Committee has examined the past to illuminate the attitudes and perceptions that shaped these clandestine programs using American institutions and to determine whether the internal CIA regulations established in 1967 are sufficient to prevent the large scale programs of the past from being reinstated in the future.

Some of these concerns were addressed almost a decade ago during an investigation that proved to be a watershed in the Central Intelligence Agency's relationship to American institutions. President Lyndon Johnson, moved by public and congressional uproar over the 1967 disclosure of the CIA's covert funding of the National Student Association (NSA) and other domestic private institutions, established the Katzenbach Committee. The Committee, chaired by the then Under Secretary of State, Nicholas Katzenbach, directed its investigation primarily at the CIA's covert funding of American educational and private voluntary organizations. The recommendations of the Katzenbach Committee, although they had great impact on the CIA's operations, spoke only to the issue of the covert funding of institutions.

In its investigation the Committee has looked not only at the impact of foreign clandestine operations on American institutions but has focused particular attention on the covert use of *individuals*. It should be emphasized from the outset that the integrity of these institutions or individuals is not jeopardized by open contact or cooperation with Government intelligence institutions. United States Government support and cooperation, openly acknowledged, plays an essential role in American education. Equally important, Government policymakers draw on the technical expertise and advice available from academic consultants and university-related research organizations. Open and regular contact with Government agencies is a necessary part of the journalist's responsibility, as well.

A secret or a covert relationship with any of these institutions, however, is another matter, and requires careful evaluation, given the critical role these institutions play in maintaining the freedom of our society. In approaching the subject the Committee has inquired: Are the independence and integrity of American institutions in any way endangered by clandestine relationships with the Central Intelligence Agency? Should clandestine use of institutions or individuals within those institutions be permitted? If not, should there be explicit guidelines laid down to regulate Government clandestine support or operational use of such institutions or individuals? Should such guidelines be in the form of executive directives or by statute?

In addressing these issues, the Committee's access to CIA documents and files varied with the subject matter. In reviewing the clandestine activities that preceded the Katzenbach Committee inquiry of 1967, the Select Committee had full and unfettered access to most files and documentation, with the single exception of records on media relationships. In addition, the Committee took extensive sworn testimony from virtually all of those involved in the management and review of the pre-1967 projects. Access to post-1967 material was far more re-

stricted: certain of the titles and names of authors of propaganda books published after 1967 were denied the Committee; access to files on the contemporary clandestine use of the American academic community was restricted to information which would provide the numbers of institutions and individuals involved and a description of the role of the individuals. As for the media and relationships with religious groups, the Committee inspected precis or summaries of all operational relationships since 1951 and then selected over 20 cases for closer inspection. The documents from these some 20 files were selected and screened by the Agency and, by mutual agreement, names of individuals and institutions were removed.

Therefore, the Committee has far from the full picture of the nature and extent of these relationships and the domestic impact of foreign clandestine operations. Nevertheless, it has enough to outline the dimensions of the problem and to underscore its serious nature. The conclusions and recommendations must necessarily be considered tentative and subject to careful review by the successor intelligence oversight committee(s) of the Congress.

In presenting the facts and issues associated with CIA covert relations with United States private institutions, this report is organized as follows: I. Covert Use of Academic and Voluntary Organizations. II. Covert Relationships with the United States Media. III. Covert Use of United States Religious Groups.

A. COVERT USE OF ACADEMIC AND VOLUNTARY ORGANIZATIONS

The Central Intelligence Agency has long-developed clandestine relationships with the American academic community, which range from academics making introductions for intelligence purposes² to intelligence collection while abroad, to academic research and writing where CIA sponsorship is hidden. The Agency has funded the activities of American private organizations around the world when those activities supported—or could be convinced to support—American foreign policy objectives. Until 1967 the Agency also maintained covert ties to American foundations in order to pass funds secretly to private groups whose work the CIA supported.

The relationships have varied according to whether made with an institution or an individual, whether the relationship is paid or unpaid, or whether the individuals are "witting"—i.e. aware—of CIA involvement. In some cases, covert involvement provided the CIA with little or no operational control of the institutions involved; funding was primarily a way to enable people to do things they wanted to do. In other cases, influence was exerted. Nor was the nature of these relationships necessarily static; in the case of some individuals support turned into influence, and finally even to operational use.

During the 1950s and 1960s, the CIA turned increasingly to covert action in the area of student and labor matters, cultural affairs, and community developments. The struggle with communism was seen to be, at center, a struggle between our institutions and theirs. The CIA subsidized, advised, and even helped develop "private" organizations that would compete with the communists around the world. Some of

² For explanation of italics, see footnote, p. 170.

these organizations were foreign; others were international; yet others were U.S.-based student, labor, cultural, or philanthropic organizations whose international activities the CIA subsidized.

The CIA's interest in the areas of student and labor matters, cultural affairs, and community development reached a peak in the mid-1960's. By 1967, when public disclosure of NSA's funding and the subsequent report of the Katzenbach Committee caused a major curtailment of these activities, interest in the major covert action efforts in these areas was already waning.

There appear to be two reasons for this. First, there was considerable skepticism within the CIA as to the effectiveness of this approach. It differed from classical CIA "tradecraft" in that the organizations funded were basically independent from CIA control. Richard Helms expressed this skepticism when he remarked in testimony before this committee,

The clandestine operator . . . is trained to believe that you really can't count on the honesty of your agent to do exactly what you want or to report accurately unless you own him body and soul.^{2a}

Mr. Helms contended that "the clandestine operator sneered at the other kind of operation"—the aiding and abetting of people or organizations who are your "friends" or "have the same point of view that you do."

Skepticism of the clandestine operators was directed particularly at the Covert Action Staff/International Organizations Division, the CIA units which conducted the programs in the area of student and cultural exchange. Second, it became increasingly difficult to conceal the CIA funds that supported these activities as the scale of the operations grew. By fiscal year 1967, for example, over \$3 million was budgeted for youth and student programs and \$6 million for labor. Most of the funds were transmitted through legitimate or "devised" foundations—that is, fictitious entities established by the CIA.

1. CIA Use of Private Foundations, Pre-1967

The use of philanthropic organizations was a convenient way to pass funds, in that large amounts could be transferred rapidly, and in a form that need not alert unwitting officers of the recipient organizations to their source. In addition, foundation grants bestowed upon the recipient the apparent "blessing" of the foundation. The funding pattern involved a mixture of bona fide charitable foundations, devised foundations and funds, "front men" drawn from a list of America's most prominent citizens, and lawyers representing undisclosed clients.

The CIA's intrusion into the foundation field in the 1960s can only be described as massive. Excluding grants from the "Big Three"—Ford, Rockefeller, and Carnegie—of the 700 grants over \$10,000 given by 164 other foundations during the period 1963-1966, at least 108 involved partial or complete CIA funding. More importantly, CIA funding was involved in nearly half the grants the non-"Big Three" foundations made during this period in the field of international activities. In the same period more than one-third of the grants awarded by non-"Big Three" in the physical, life and social sciences also involved CIA funds.

^{2a} Richard Helms testimony, 9/12/75, p. 25-26.

Bona fide foundations, rather than those controlled by the CIA, were considered the best and most plausible kind of funding cover for certain kinds of operations. A 1963 CIA study explained the use of legitimate foundations was the most effective way of concealing the CIA's hand as well as reassuring members of funded organizations that the organization was in fact supported by private funds. The Agency study contended that this technique was "particularly effective for democratically-run membership organizations, which need to assure their own unwitting members and collaborators, as well as their hostile critics, that they have genuine, respectable, private sources of income."

2. The CIA's Foundation-funded Covert Activity, Pre-1967

The philanthropic fronts used prior to 1967 funded a seemingly limitless range of covert action programs affecting youth groups, labor unions, universities, publishing houses, and other private institutions in the United States and abroad. The following list illustrates the diversity of these operations:

(1) The CIA assisted in the establishment in 1951 and the funding for over a decade of a research institute at a major American university. This assistance came as the result of a request from Under-secretary of State James Webb to General Bedell Smith, then Director of the CIA. Mr. Webb proposed that the center, which was to research worldwide political, economic, and social changes, be supported by the CIA in the interest of the entire intelligence community.

(2) *A project was undertaken in collaboration with a nationally prominent American business association. The object of the project was to promote a favorable image of America in a foreign country unfavorably disposed to America and to promote citizen-to-citizen contacts between Americans and influential segments of that country's society.*³

(3) The cooperation of an American labor organization in selected overseas labor activities.

(4) Support of an international organization of veterans and an international foundation for developing countries.

(5) Support of an organization of journalists and an international women's association.

(6) Partial support for an international educational exchange program run by a group of United States universities.

(7) Funding of a legitimate U.S. association of farm organizations. Agency funds were used to host foreign visitors, provide scholarships to an international cooperative training center at a United States university, and to reimburse the organization for various of its activities abroad. A CIA document prepared in 1967 notes that although the organization received some overt government funds from AID, the CIA should continue its covert funding because "programs funded by AID cannot address themselves to the same political goals toward which Agency operations are targeted because AID programs are part of official government-to-government programs and are designed for economic—not political—results."

³ For explanation of italics, see footnote, p. 179.

The Best Known Case: Covert Funding of the National Student Association

CIA funding of the National Student Association (NSA) from 1952 to 1967 is a particularly good example of how the United States Government entered the field of covertly supporting "friends," of the vulnerabilities felt by the CIA in undertaking to support organizations and individuals that cannot be controlled, and of the operational temptation to move from support to "control."

The reason the CIA decided to help NSA is clear. In the years immediately after World War II the Soviet Union took the lead in trying to organize and propagandize the world student movement. The first Soviet Vice President of the International Union of Students, for example, was Alexander N. Shelepin, who later became Chairman of the Soviet State Security Committee (KGB). The American students who sought to compete with these communist-managed and directed student group were hampered by a lack of funds, while the communist groups had enough money to put on world youth festivals, conferences and forums, and regional conferences. In seeking funds at home, the American students found they were considered too far to the left in the general climate of McCarthyism and anti-intellectualism of the 1950s. Against this background, NSA officials, after being refused by the State Department and rebuffed by the Congress, were finally directed by the State Department in 1952 to the CIA.⁴

The CIA maintains that its funding efforts were based on shared interests, not on manipulation. CIA funding of the National Student Association appears to have been intended primarily to permit United States students to represent their own ideas, in their own way, in the international forums of the day. Nevertheless, the Committee has found instances in which the CIA moved from blank-check support to operational use of individual students.⁵

For example, over 250 U.S. students were sponsored by the CIA to attend youth festivals in Moscow, Vienna, and Helsinki and were used for missions such as reporting on Soviet and Third World personalities or observing Soviet security practices. A United States student, for example, was recruited in 1957 to serve as a CIA "asset" at the Sixth World Youth Festival in Moscow. According to CIA documents, he was instructed to report on Soviet counterintelligence measures and to purchase a piece of Soviet-manufactured equipment.

⁴ Under the agreed arrangement, CIA funds would support only the international division of the National Student Association; only the NSA President and the International Affairs Vice President would be witting of the CIA connection. Each year, after the election of new student leaders, the CIA held a secret briefing for the new officers, and elicited from them a secrecy agreement. During the 1960s however, witting National Student Association leaders became increasingly restive about the CIA sponsorship, until finally in 1967 one of them revealed the relationship to *Ramparts* magazine.

⁵ "Operational use" of individuals as used in this report means recruitment, use, or training, on either a witting or unwitting basis, for intelligence purposes. That is, the individual is directed or "tasked" to do something for the CIA—as opposed to volunteering information. Such purposes include covert action, clandestine intelligence collection (espionage) and various kinds of support functions.

Although the CIA's involvement with the National Student Association was limited to the organization's international activities, CIA influence was felt to some extent in its domestic programs as well. The most direct way in which such influence may have been felt was in the selection process for NSA officers. The Summer International Seminars conducted for NSA leaders and potential leaders in the United States during the 1950's and 1960's were a vehicle for the Agency to identify new leaders and to promote their candidacy for elective positions in the National Student Association.

The Central Intelligence Agency's experience with the NSA underlines the basic problem of an action-oriented clandestine organization entering into a covert funding relationship with private organizations: support of friends turns into the control of their actions and ultimately to creation of new "friends."

3. Cover is Blown: The Patman and Ramparts "Flaps"

In a public hearing in 1964, Congressman Wright Patman, Chairman of the Subcommittee on Foundations of the House Committee on Problems of Small Businesses, revealed the names of eight of the CIA's funding instruments—the so-called "Patman Eight." These disclosures sharply jarred the Agency's confidence in the security of these philanthropic funding mechanisms.

The Patman disclosures led the CIA to take a hard look at this technique of funding, but not to reconsider the propriety of bringing the independence of America's foundations into question by using them as conduits for the funding of covert action projects. According to the Chief of the Covert Action Staff's Program and Evaluation Group:

The real lesson of the Patman Flap is not that we need to get out of the business of using foundation cover for funding, but that we need to get at it more professionally and extensively.

Despite the best efforts of the Agency throughout 1966 to shore up its vulnerable funding mechanisms, it became increasingly clear that *Ramparts* magazine, the *New York Times*, and the *Washington Post* were moving ever closer to unraveling not only the CIA's system of clandestine funding but to exposing the source of the support for the National Student Association. In an effort to determine whether there was foreign influence on funds behind the *Ramparts* exposé, the CIA, in coordination with the FBI, undertook through its own counterintelligence staff to prepare extensive reports on the *Ramparts* officers and staff members.⁶

At a press briefing on February 14, 1967, the State Department publicly confirmed a statement by leaders of NSA that their organization had received covert support from the CIA since the early 1950s. The NSA statement and disclosures in *Ramparts* magazine brought on a storm of public and congressional criticism. In response, President

⁶ The Agency appointed a special assistant to the Deputy Director for Plans, who was charged with "pulling together information on *Ramparts*, including any evidence of subversion [and] devising proposals for counteraction." In pursuing the "Communist ties" of *Ramparts* magazine, the "case" of managing editor, Robert Scheer, was one of the first to be developed and a report was sent on Scheer to Walt W. Rostow, Special Assistant to President Johnson.

Johnson organized a committee composed of Undersecretary of State Nicholas Katzenbach, Secretary of HEW John Gardner, and CIA Director Richard Helms to review government activities that may "endanger the integrity and independence of the educational community." The committee's life was short—43 days—but its recommendations, accepted by President Johnson on March 29, 1967, were to have a profound effect on the CIA's clandestine operations, both in the United States and abroad.

4. *The Katzenbach Committee*

President Johnson's concern for the integrity and independence of American institutions could have resulted in the Katzenbach Committee being charged with general review of the domestic impact of clandestine activities and their effect on American institutions; including consideration of whether all covert relationships should be prohibited, and, if not, what guidelines should be imposed on the use of institutions and individuals.

Instead, the Johnson Administration carefully and consciously limited the mandate of the Katzenbach Committee's investigation to the relationship between the CIA and "U.S. educational and private voluntary organizations which operate abroad." In a February 24 memorandum to Gardner and Helms, Katzenbach cited the narrowness of the mandate in listing problems faced by the Committee:

1. The narrow scope of this mandate, as compared with the demands, by Senator Mansfield, et al, that this flap be used as a springboard for a review of all clandestine financing by CIA.

2. More specifically, the exclusion in this mandate of relationships between CIA and American businesses abroad.

3. Focusing the mandate on CIA, rather than on all private organization relationships with government agencies.

In testimony before this Committee, Mr. Katzenbach said that his committee was designed by President Johnson not only to deal with the relationship of the CIA to educational and voluntary organizations, but to head off a full-scale congressional investigation.⁷

All other covert relationships were to be excluded from the investigation. In a memo to his colleagues, the Deputy Chief of the Covert Action Staff reported:

It is stated that the country operations funded by black bag [sterilized or laundered funds] were not to be included in the CIA's response to the Katzenbach Commission and emphasized that the focus of this paper was to be on organizations.

In addition the Katzenbach Committee did not undertake investigation of CIA domestic commercial operations, specifically those designed to provide cover for clandestine intelligence operations which

⁷ Nicholas Katzenbach testimony, 10/11/75, p. 5. Katzenbach also said of the President's decision on membership:

"... he [the President] wanted John Gardner on it because he thought that would help politically in getting acceptance of whatever the recommendations turned out to be because he thought Helms would defend everything and wanted to continue everything. Gardner would want to stop everything. It was my job to come out with something in the middle." (*Ibid*).

the U.S. directed at such targets as foreign students, foreign businessmen, foreign diplomatic and consular officials travelling or residing in the United States.

Despite the narrowness of its mandate, the actual investigation of the Katzenbach Committee was vigorous and thorough. After deliberation, the Committee issued the basic recommendation that:

It should be the policy of the United States Government that no federal agency shall provide any covert financial assistance or support, direct or indirect, to any of the nation's educational or private voluntary organizations.

In May 1967 the Deputy Director for Plans Desmond FitzGerald interpreted the post-Katzenbach ground rules in a circular to the field. He stated:

Several operational guidelines emerge:

- a. Covert relations with commercial U.S. organizations are not, repeat, not barred.
- b. Covert funding overseas of foreign-based international organizations is permitted.

He indicated that greater care would be needed in the conduct of clandestine operations, in order to prevent disclosures:

- a. The care required under the Katzenbach Report, with respect to the recruitment and use of U.S. students, and U.S. university professors, applies equally to the recruitment and use of foreign students. . . .

In simple terms, we are now in a different ballgame. Some of the basic ground rules have changed. When in doubt, ask HQs.

5. A Different Ballgame: CIA Response to Katzenbach

The policy guidelines established in the Katzenbach Report and supplemental guidelines with which the CIA interpreted the Report brought major adjustments in covert action programs and methods. Some 77 projects were examined at high levels within the CIA, and lists were drawn up of projects to be terminated, projects to be transferred to other sources of funding, projects to continue, and projects whose future required higher level decisions. The 303 Committee met frequently throughout 1967 and 1968 to deal with difficult questions, such as how to provide for continued funding of Radio Free Europe and Radio Liberty.

At the same time the Agency was withdrawing from support of a large number of domestically-based organizations, it moved rapidly to shelter certain high-priority operations from the Katzenbach prohibitions and to devise more secure funding mechanisms. This process was facilitated by what was termed "surge funding." The Katzenbach guidelines called for termination of CIA funding of domestically based U.S. organizations by December 31, 1967. With 303 Committee approval for the largest grants, the Agency "surge funded" a number of organizations, giving them advances before the December deadline which carried them in some cases for up to two years of operations. Radio Free Europe and Radio Liberty were so funded.

In adjusting to the "new ballgame," the appearance of contravening the Katzenbach guidelines, rather than specific regulations, was

seen as a reason not to continue relationships with certain institutions. At the same time, at least one case suggests that even a clean termination of funding with a private organization did not necessarily end the CIA's support of the policies and programs of the organization. A CIA report on termination plans for a large project in the Far East indicated that, with surge funding, the organization could continue into fiscal year 1969, and that thereafter "[the organization's] Board of Trustees will assume full responsibility for the organization and has pledged to continue its policies and range of activities."

The following are examples of the score of projects which the CIA reviewed in 1967 and decided to continue to fund:

(1) A publications and press institute that maintained a worldwide network of stringers and correspondents. A CIA report on the project asserted that it "exerts virtually no domestic influence in any quarter, although its publications are read by U.S. students."

(2) Several international trade union organizations.

(3) A foreign-based news feature service.

(4) A foreign-based research and publishing institute.

In reviewing the CIA's adjustments to the Katzenbach Committee's recommendations, the Committee found no violations of the policy the report sets forth. However, it is important to recognize how narrow the focus of the Katzenbach Committee's concern was. The problem was approached by the committee and by the CIA essentially as one of security: how to limit the damage caused by the revelations of CIA relationships with private U.S. institutions. Many of the restrictions developed by the CIA in response to the events of 1967 appear to be security measures aimed at preventing further public disclosures which could jeopardize sensitive CIA operations. They did not represent significant rethinking of where boundaries ought to be drawn in a free society. Moreover, although President Johnson adopted the Katzenbach report as policy, it was not issued as an executive order or enacted as a statute. Thus, it has no firm legal status.

6. Post 1967 Relations with the U.S. Academic Community

In analyzing the adequacy of the Katzenbach regulations and of the CIA's compliance with them, the Select Committee concentrated much of its attention on contemporary relationships between the CIA and the U.S. academic community. The Committee interprets "academic community" to include more than the Katzenbach Committee undoubtedly had in mind when it recommended prohibition of "covert financial assistance or support . . . to any of the nation's educational . . . organizations." "Academic community" has been interpreted by this Committee to include universities, university-related research centers, and the full range of individual scholars and school administrators, ranging from department heads to career counselors and to Ph.D. candidates engaged in teaching. The Committee has approached this inquiry with three principal questions:

(1) What is the extent and nature of CIA relationships with U.S. academic institutions and with individual American academics?

(2) What are the guidelines and ground rules governing CIA post-Katzenbach relations with the academic community?

(3) What issues are at stake; what threats, if any, do current relations pose for the independence of this influential sector of society?

The CIA relationships with the academic community are extensive and serve many purposes, including providing leads and making introductions for intelligence purposes, collaboration in research and analysis, intelligence collection abroad, and preparation of books and other propaganda materials.

The Select Committee's concentration has been on the area of clandestine relationships untouched by the Katzenbach Committee—individuals.

7. Covert Relations with Individuals in the Academic Community

As already noted, from the first days of the Katzenbach Committee, the CIA proceeded on the operating assumption that the inquiry was directed squarely at institutional relationships—not individuals in or affiliated with those private institutions. After the Katzenbach report, the Agency issued a basic instruction entitled "Restrictions on Operational Use of Certain Categories of Individuals." This instruction remains in force today. The instruction states that the "basic rule" for the use of human agents by the Operations Directorate is that "any consenting adult" may be used.

While all members of the American academic community, including students, certainly qualify as "consenting adults," the CIA since 1967 has been particularly sensitive to the risks associated with their use. In order to control and confine contacts with American academics, the handling of relationships with individuals associated with universities is largely confined to two CIA divisions of the Directorate of Operations—the Domestic Collection Division and the Foreign Resources Division. The Domestic Collection Division is the point of contact with large numbers of American academics who travel abroad or who are otherwise consulted on the subject of their expertise. The Foreign Resources Division, on the other hand, is the purely operational arm of the CIA in dealing with American academics. Altogether, DCD and FRD are currently in contact—ranging from the occasional debriefing to a continuing operational relationship—with many thousands of United States academics at hundreds of U.S. academic institutions.

It is imperative to underline that the majority of these relationships are purely for the purpose of asking an academic about his travels abroad or open informal consulting on subjects of the academic's expertise. The Committee sees no danger to the integrity of American private institutions in continuing such contacts; indeed, there are benefits to both the government and the universities in such contacts.

The CIA's Office of Personnel also maintains relationships with university administrators, sometimes in the placement office. These relationships, which are usually contractual, enable the CIA to approach suitable United States students for CIA employment.

The "operational use" of academics is another matter. It raises troubling questions as to preservation of the integrity of American academic institutions.

8. Covert Use of the U.S. Academic Community

The Central Intelligence Agency is now using several hundred American academics¹¹, who in addition to providing leads and, on

¹¹ "Academics" includes administrators, faculty members and graduate students engaged in teaching.

occasion, making introductions for intelligence purposes, occasionally write books and other material to be used for propaganda purposes abroad. Beyond these, an additional few score are used in an unwitting manner for minor activities.

These academics are located in over 100 American colleges, universities, and related institutes. At the majority of institutions, no one other than the individual concerned is aware of the CIA link. At the others, at least one university official is aware of the operational use made of academics on his campus. In addition, there are several American academics abroad who serve operational purposes, primarily the collection of intelligence.¹²

The CIA considers these operational relationships with the United States academic community as perhaps its most sensitive domestic area and has strict controls governing these operations. According to the Agency's internal directives, the following distinctions govern the operational use of individuals: the CIA's directives prohibit the operational use of individuals who are receiving support under the Mutual Education and Cultural Exchange Act of 1961, commonly known as the Fulbright-Hays Act. Falling under this particular prohibition are teachers, research scholars, lecturers, and students who have been selected to receive scholarships or grants by the Board of Foreign Scholarships. This prohibition specifically does not apply to the several other categories of grantees supported by other provisions of the Fulbright-Hays Act, such as artists, athletes, leaders, specialists, or participants in international trade fairs or expositions, who do not come under the aegis of the President's Board of Foreign Scholarships. As far as the three major foundations—Ford, Rockefeller and Carnegie—are concerned, the prohibition extends to "persons actively participating in programs which are wholly sponsored and controlled by any of these foundations. Additionally, there will be no operational use made of the officials or employees of these organizations." (These large foundations were cited by a CIA official in 1966 before the 303 Committee as "a trouble area in New York City—reluctant to cooperate on joint ventures.")

9. Covert Relationships with Academic and Voluntary Organizations: Conclusions

With respect to CIA covert relationships with private institutions and voluntary organizations, the Committee concludes:

(1) The CIA has adhered to the 1967 Katzenbach guidelines governing relationships with domestic private and voluntary institutions. The guidelines are so narrowly focused, however, that the covert use of American individuals from these institutions has continued.

(2) American academics are now being used for such operational purposes as making introductions for intelligence purposes^{12a} and working for the Agency abroad. Although the numbers are not as great today as in 1966, there are no prohibitions to prevent an increase in the operational use of academics. The size of these operations is determined by the CIA.

(3) With the exception of those teachers, scholars and students who receive scholarships or grants from the Board of Foreign Scholar-

¹² For explanation of italics, see footnote, p. 179.

^{12a} *Ibid.*

ships, the CIA is not prohibited from the operational use of all other categories of grantee support under the Fulbright-Hays Act (artists, athletes, leaders, specialists, etc.). Nor is there any prohibition on the operational use of individuals participating in any other exchange program funded by the United States Government.

In addressing the issues of the CIA's relationship to the American academic community the Committee is keenly aware that if the CIA is to serve the intelligence needs of the nation, it must have unfettered access to the best advice and judgment our universities can produce. But this advice and expertise can and should be openly sought—and openly given. Suspicion that such openness of intellectual encounter and exchange is complemented by covert operational exploitation of academics and students can only prejudice, if not destroy, the possibility of a full and fruitful exchange between the nation's best minds and the nation's most critical intelligence needs. To put these intellects in the service of the nation, trust and confidence must be maintained between our intelligence agencies and the academic community.

The Committee is disturbed both by the present practice of operationally using American academics and by the awareness that the restraints on expanding this practice are primarily those of sensitivity to the risks of disclosure and *not* an appreciation of dangers to the integrity of individuals and institutions. Nevertheless, the Committee does not recommend a legislative prohibition on the operational exploitation of individuals in private institutions by the intelligence agencies. The Committee views such legislation as both unenforceable and in itself an intrusion on the privacy and integrity of the American academic community. The Committee believes that it is the responsibility of private institutions and particularly the American academic community to set the professional and ethical standards of its members. This report on the nature and extent of covert individual relations with the CIA is intended to alert these institutions that there is a problem.

At the same time, the Committee recommends that the CIA amend its internal directives to require that individual academics used for operational purposes by the CIA, together with the President or equivalent official of the relevant academic institutions, be informed of the clandestine CIA relationship.

The Committee also feels strongly that there should be no operational use made of professors, lecturers, students, artists, and the like who are funded under United States Government-sponsored programs. The prohibition on the operational use of Fulbright grantees must be extended to other government-sponsored programs; and in this case the prohibition should be confirmed by law, given the direct responsibility of the Congress for these programs. It is unacceptable that Americans would go overseas under a cultural or academic exchange program funded openly by the United States Congress and at the same time serve an operational purpose directed by the Central Intelligence Agency.

B. COVERT RELATIONSHIPS WITH THE UNITED STATES MEDIA

In pursuing its foreign intelligence mission the Central Intelligence Agency has used the U.S. media for both the collection of intelligence

and for cover. Until February 1976, when it announced a new policy toward U.S. media personnel, the CIA maintained covert relationships with about 50 American journalists or employees of U.S. media organizations. *They are part of a network of several hundred foreign individuals around the world who provide intelligence for the CIA and at times attempt to influence foreign opinion through the use of covert propaganda. These individuals provide the CIA with direct access to a large number of foreign newspapers and periodicals, scores of press services and news agencies, radio and television stations, commercial book publishers, and other foreign media outlets.*¹³

The CIA has been particularly sensitive to the charge that CIA covert relationships with the American media jeopardize the credibility of the American press and risk the possibility of propagandizing the U.S. public. Former Director William Colby expressed this concern in recent testimony before the House Select Committee on Intelligence:

We have taken particular caution to ensure that our operations are focused abroad and not at the United States in order to influence the opinion of the American people about things from a CIA point of view.

As early as 1967, the CIA, in the wake of the National Student Association disclosure, moved to flatly prohibit the publication of books, magazines, or newspapers in the United States. More recently, George Bush, the new Director, undertook as one of his first actions to recognize the "special status afforded the American media under our Constitution" and therefore pledged that "CIA will not enter into any paid or contractual relationship with any full-time or part-time news correspondent accredited by any United States news service, newspaper, periodical, radio or television network or station."¹⁴

In approaching the subject of the CIA's relationship with the United States media, the Select Committee has been guided by several broad concerns. It has inquired into the covert publication of propaganda in order to assess its domestic impact; it has investigated the nature and purpose of the covert relationships that the CIA maintains with bona fide U.S. journalists; it has examined the use of journalistic "cover" by CIA agents; it has pursued the difficult issue of domestic "fallout" from CIA's foreign press placements and other propaganda activities. Throughout, it has compared current practice to the regulations restricting activities in this area, in order both to establish whether the CIA has complied with existing regulations, and, more important, in order to evaluate the adequacy of the regulations themselves.

1. Books and Publishing Houses

Covert propaganda is the hidden exercise of the power of persuasion. In the world of covert propaganda, book publishing activities have a special place. In 1961 the Chief of the CIA's Covert Action

¹³ For explanation of footnotes, see p. 179.

¹⁴ George Bush statement, 2/11/70.

Staff, who had responsibility for the covert propaganda program, wrote:

Books differ from all other propaganda media, primarily because one single book can significantly change the reader's attitude and action to an extent unmatched by the impact of any other single medium . . . this is, of course, not true of all books at all times and with all readers—but it is true significantly often enough to make books the most important weapon of strategic (long-range) propaganda.

According to The Chief of the Covert Action Staff, the CIA's clandestine handling of book publishing and distribution could:

(a) Get books published or distributed abroad without revealing any U.S. influence, by covertly subsidizing foreign publications or booksellers.

(b) Get books published which should not be "contaminated" by any overt tie-in with the U.S. government, especially if the position of the author is "delicate."

(c) Get books published for operational reasons, regardless of commercial viability.

(d) Initiate and subsidize indigenous national or international organizations for book publishing or distributing purposes.

(e) Stimulate the writing of politically significant books by unknown foreign authors—either by directly subsidizing the author, if covert contact is feasible, or indirectly, through literary agents or publishers.

Well over a thousand books were produced, subsidized or sponsored by the CIA before the end of 1967. Approximately 25 percent of them were written in English. Many of them were published by cultural organizations which the CIA backed, and more often than not the author was unaware of CIA subsidization. Some books, however, involved direct collaboration between the CIA and the writer. The Chief of the Agency's propaganda unit wrote in 1961:

The advantage of our direct contact with the author is that we can acquaint him in great detail with our intentions; that we can provide him with whatever material we want him to include and that we can check the manuscript at every stage. Our control over the writer will have to be enforced usually by paying him for the time he works on the manuscript, or at least advancing him sums which he might have to repay . . . [the Agency] must make sure the actual manuscript will correspond with our operational and propagandistic intention. . . .

The Committee has reviewed a few examples of what the Chief of the Covert Action Staff termed "books published for operational reasons regardless of commercial viability." Examples included:

(1) A book about the conflict in Indochina was produced in 1954 at the initiation of the CIA's Far East Division. A major U.S. publishing house under contract to the CIA published the book in French and English. Copies of both editions were distributed to foreign embassies

in the United States, and to selected newspapers and magazine editors both in the United States and abroad.

(2) A book about a student from a developing country who had studied in a communist country "was developed by [two area divisions of the CIA] and produced by the Domestic Operations Division . . . and has had a high impact in the U.S. as well as the [foreign area] market." The book, which was published by the European outlet of a U.S. publishing house, was published in condensed form in two major U.S. magazines. Eric Sevareid, the CBS political commentator, in reviewing this book, spoke a larger truth than he knew when he suggested that "our propagandist services could do worse than to flood [foreign] university towns with this volume."

(3) Another CIA book, the *Penkovskiy Papers*, was published in the United States in 1965 "for operational reasons", but actually became commercially viable. The book was prepared and written by witting Agency assets who drew on actual case materials. Publication rights to the manuscript were sold to a publisher through a trust fund which was established for the purpose. The publisher was unaware of any U.S. Government interest.

The publishing program in the period before the National Student Association disclosures was large in volume and varied in taste. In 1967 alone the CIA published or subsidized well over 200 books, ranging from books on wildlife and safaris to translations of Machiavelli's *The Prince* into Swahili and works of T. S. Eliot into Russian, to a parody of the famous little red book of quotations from Mao entitled *Quotations from Chairman Liu*.

The publicity which in 1967 surrounded several CIA sponsored organizations and threatened to expose others caused the CIA to act quickly to limit its use of U.S. publishers. In direct response to the Katzenbach report, Deputy Director for Plans Desmond Fitzgerald ordered, "We will, under no circumstances, publish books, magazines or newspapers in the United States."

With this order, the CIA suspended direct publication and subsidization within the United States not only of books, but also of journals and newsletters, including: a magazine published by a United States-based proprietary for cultural and artistic exchange; a newsletter mailed to foreign students studying in North American universities under the sponsorship of a CIA proprietary foundation; and a publication on Latin American affairs published in the United States.

Thus since 1967 the CIA's publishing activities have almost entirely been confined to books and other materials published abroad. During the past few years, some 250 books have been published abroad, most of them in foreign languages.

As previously noted, the CIA has denied to the Committee a number of the titles and names of authors of the propaganda books published since 1967. Brief descriptions provided by the Agency indicate the breadth of subject matter, which includes the following topics, among many others:

- (1) Commercial ventures and commercial law in South Vietnam;
- (2) Indochina representation at the U.N.;
- (3) A memoir of the Korean War;

- (4) The prospects for European union;
- (5) Chile under Allende.

2. Covert Use of U.S. Journalists and Media Institutions

On February 11, 1976, the CIA announced new guidelines governing its relationship with U.S. media organizations:

Effective immediately, CIA will not enter into any paid or contractual relationship with any full-time or part-time news correspondent accredited by any U.S. news service, newspaper, periodical, radio or television network or station.¹⁶

Of the approximately 50 U.S. journalists or personnel of U.S. media organizations who were employed by the CIA or maintained some other covert relationship with the CIA at the time of the announcement, fewer than one-half will be terminated under the new CIA guidelines.

About half of the some 50 CIA relationships with the U.S. media were paid relationships, ranging from salaried operatives working under journalistic cover, to U.S. journalists serving as "independent contractors" for the CIA and being paid regularly for their services, to those who receive only occasional gifts and reimbursements from the CIA.¹⁷

*More than a dozen United States news organizations and commercial publishing houses formerly provided cover for CIA agents abroad. A few of these organizations were unaware that they provided this cover.*¹⁸

Although the variety of the CIA relationships with the U.S. media makes a systematic breakdown of them almost impossible, former CIA Director Colby has distinguished among four types of relationships.¹⁹ These are:

- (1) Staff of general circulation, U.S. news organizations;
- (2) Staff of small, or limited circulation, U.S. publications;
- (3) Free-lance, stringers, propaganda writers, and employees of U.S. publishing houses;
- (4) Journalists with whom CIA maintains unpaid, occasional, covert contact.

While the CIA did not provide the names of its media agents or the names of the media organizations with which they are connected, the Committee reviewed summaries of their relationships and work with the CIA. Through this review the Committee found that as of February 1976:

- (1) The first category, which would include any staff member of a general circulation U.S. news organization who functions as a paid undercover contact of the CIA, appears to be virtually phased out. The

¹⁶ According to the CIA, "accredited" applies to individuals who are "formally authorized by contract or issuance of press credentials to represent themselves as correspondents."

¹⁷ Drawn from "operational case studies" provided to the Committee 12/16/75 and 10/21/75.

¹⁸ For explanation of footnotes, see p. 170.

¹⁹ On November 30, 1973, the *Washington Star-News* reported that Director Colby had ordered a review of CIA media relationships in September of that year, and reported that Colby would phase out the first category but maintain journalists in each of the other three categories. In his testimony to the House Select Committee on Intelligence on November 6, 1975, Colby made a general reference to these categories.

Committee has found only two current relationships that fit this category, both of which are being terminated under the CIA's February 11, 1976 stated policy.

The Committee has also found a small number of past relationships that fit this category. In some cases the cover arrangement consisted of reimbursing the U.S. newspaper for any articles by the CIA agent which the paper used. In at least one case the journalistic functions assumed by a CIA staff officer for cover purposes grew to a point where the officer concluded that he could not satisfactorily serve the requirements of both his (unwitting) U.S. media employers and the CIA, and therefore resigned from the CIA. He maintained contact, however, with the CIA and continued, very occasionally, to report to the CIA from the countries in which he worked.

(2) Of the less than ten relationships with writers for small, or limited circulation, U.S. publications, such as trade journals or newsletters, most are for cover purposes.

(3) The third, and largest, category of CIA relationships with the U.S. media includes free-lance journalists; "stringers" for newspapers, news magazines and news services; itinerant authors; propaganda writers; and agents working under cover as employees of U.S. publishing houses abroad. With the exception of the last group, the majority of the individuals in this category are bona fide writers or journalists or photographers. Most are paid by the CIA, and virtually all are witting; few, however, of the news organizations to which they contribute are aware of their CIA relationships.

(4) The fourth category of covert relationships resembles the kind of contact that journalists have with any other department of the U.S. Government in the routine performance of their journalistic duties. No money changes hands. The relationships are usually limited to occasional lunches, interviews, or telephone conversations during which information would be exchanged or verified. The difference, of course, is that the relationships are covert. The journalist either volunteers or is requested by the CIA to provide some sort of information about people with whom he is in contact. In several cases, the relationship began when the journalist approached a U.S. embassy officer to report that he was approached by a foreign intelligence officer; in others, the CIA initiated the relationship.

The first major step to impose restrictions on the use of U.S. journalists was taken by former Director Colby in the fall of 1973. According to Mr. Colby's letter to the Committee:²¹

(a) CIA will undertake no activity in which there is a risk of influencing domestic public opinion, either directly or indirectly. The Agency will continue its prohibition against placement of material in the American media. In certain instances, usually where the initiative is on the part of the media, CIA will occasionally provide factual non-attributable briefings to various elements of the media, but only in cases where we are sure that the senior editorial staff is aware of the source of the information provided.

²¹ Letter from William Colby to the Select Committee, 10/21/76.

(b) As a general policy, the Agency will not make any clandestine use of staff employees of U.S. publications which have a substantial impact or influence on public opinion. This limitation includes cover use and any other activities which might be directed by CIA.

(c) A thorough review should be made of CIA use of non-staff journalists; i.e., stringers and free-lancers, and also those individuals involved in journalistic activities who are in non-sensitive journalist-related positions, primarily for cover backstopping. Our goal in this exercise is to reduce such usage to a minimum.

Mr. Colby's letter specified that operational use of staff—that is, full-time correspondents and other employees of major U.S. news magazines, newspapers, wire services, or television networks—was to be avoided. Use would be less restricted for “stringers” or occasional correspondents for these news organizations, as well as for correspondents working for smaller, technical, or specialized publications.

The public statement that the CIA issued on February 11, 1976, expressed a policy of even greater restraint:

—Effective immediately, CIA will not enter into any paid or contractual relationship with any full-time or part-time news correspondent accredited by any U.S. news service, newspaper, periodical, radio or television network or station.

—As soon as feasible, the Agency will bring existing relationships with individuals in these groups into conformity with this new policy.

—CIA recognizes that members of these groups (U.S. media and religious personnel) may wish to provide information to the CIA on matters of foreign intelligence of interest to the U.S. Government. The CIA will continue to welcome information volunteered by such individuals.²²

From CIA testimony later that month, the Committee learned that this prohibition extends to non-Americans accredited to U.S. media organizations. Nevertheless, this prohibition does not cover “unaccredited” Americans serving in U.S. media organizations, or free-lance writers. As previously noted, the CIA has informed the Committee that, of the approximately 50 CIA relationships with U.S. journalists or employees of U.S. media organizations, fewer than one-half will be terminated under the new guidelines.²³

3. Two Issues: “Fallout” and the Integrity of a Free Press

In examining the CIA's past and present use of the U.S. media, the Committee finds two reasons for concern. The first is the potential, inherent in covert media operations, for manipulating or incidentally

²² CIA instructions interpreting the new policy explain that “the term ‘contractual’ applies to any written or oral agreement obligating the Agency to provide financial remuneration including regular salaries, spot payments, or reimbursement of, out-of-pocket operational expenses or the provision of other material benefits that are clearly intended as a reward for services rendered the Agency.”

²³ CIA response of March 17, 1976 (76-0915/1).

misleading the American public. The second is the damage to the credibility and independence of a free press which may be caused by covert relationships with U.S. journalists and media organizations.

In his 1967 order prohibiting CIA publication in this country, then Deputy Director for plans Desmond FitzGerald raised the first issue. He stated:

Fallout in the United States from a foreign publication which we support is inevitable and consequently permissible.

In extensive testimony, CIA employees both past and present have conceded that there is no way to shield the American public from such "fallout." As a former senior official of the Agency put it in testimony:

There is no way in this increasingly small world of ours of insulating information that one puts out overseas and confining it to the area to where one puts it out. . . . When British intelligence was operating in the last century, they could plant an outrageous story in some local publication and feel fairly confident that no one else would ever hear about it, that would be the end of it. . . . That is no longer the case. Whether or not this type of overseas activity should be allowed to continue is subject to differing views and judgments. My own would be that we would be fools to relinquish it because it serves a very useful purpose.²⁵

The same former CIA official continued:

If you plant an article in some paper overseas, and it is a hard-hitting article, or a revelation, there is no way of guaranteeing that it is not going to be picked up and published by the Associated Press in this country.^{25a}

The domestic fallout of covert propaganda comes from many sources; books intended primarily for an English-speaking foreign audience, press placements that are picked up by international wire services, press services controlled by the CIA, and direct funding of foreign institutions that attempt to propagandize the United States public and Congress.

In the case of books, substantial fallout in the U.S. may be a necessary part of the propaganda process. For example, CIA records for 1967 state that certain books about China subsidized or even produced by the Agency "circulate principally in the U.S. as a prelude to later distribution abroad." Several of these books on China were widely reviewed in the United States, often in juxtaposition to the sympathetic view of the emerging China as presented by Edgar Snow. At least once, a book review for an Agency book which appeared in the *New York Times* was written by a CIA writer under contract. E. Howard Hunt, who had been in charge of contacts with U.S. publishers in the late 1960s, acknowledged in testimony before this Committee that CIA books circulated in the U.S., and suggested that such fallout may not have been unintentional.

²⁵ Thomas H. Karamessines testimony of a former Deputy Director for plans, 10/22/75, p. 46.

^{25a} Former Deputy Director for plans testimony, 10/22/75, p. 36.

Question. But, with anything that was published in English, the United States citizenry would become a likely audience for publication?

Mr. HUNT. A likely audience, definitely.

Question. Did you take some sort of steps to make sure that things that were published in English were kept out of or away from the American reading public?

Mr. HUNT. It was impossible because Praeger was a commercial U.S. publisher. His books had to be seen, had to be reviewed, had to be bought here, had to be read.

HUNT. If your targets are foreign, then where are they? They don't all necessarily read English, and we had a bilateral agreement with the British that we wouldn't propagandize their people. So unless the book goes into a lot of languages or it is published in India, for example, where English is a *lingua franca*, then you have some basic problems. And I think the way this was rationalized by the project review board . . . was that the ultimate target was foreign, which was true, but how much of the Praeger output actually got abroad for any impact I think is highly arguable.²⁶

An American who reads one of these books which purportedly is authored by a Chinese defector would not know that his thoughts and opinions about China are possibly being shaped by an agency of the United States Government. Given the paucity of information and the inaccessibility of China in the 1960s, the CIA may have helped shape American attitudes toward the emerging China. The CIA considers such "fallout" inevitable.

Another example of the damages of "fallout" involved two proprietary news services that the CIA maintained in Europe. Inevitably these news services had U.S. subscribers. The larger of the two was subscribed to by over 30 U.S. newspapers. In an effort to reduce the problem of fallout, the CIA made a senior official at the major U.S. dailies aware that the CIA controlled these two press services.

A serious problem arises from the possible use of U.S. publications for press placements. Materials furnished to the Committee describe a relationship which poses this problem. It began in August 1967—after the Katzenbach Committee recommendations—and continued until May 1974. In this case, a U.S.-based executive of a major U.S. newspaper was contacted by the CIA "on a confidential basis in view of his access to information of intelligence and operational interests." The news executive served as a witting, unpaid collaborator for intelligence collection, and received briefings from the CIA which "were of professional benefit" to him. The CIA materials state that:

It was visualized that . . . propaganda (if agreeable to him) might be initially inserted in his paper and then be available for reprinting by Latin American news outlets. . . . There is no indication in the file that Subject agreed . . . or that he did place propaganda in his newspaper.²⁷

²⁶ E. Howard Hunt testimony, 1/10/76 pp. 73, 74.

²⁷ CIA Operational case study #14.

The danger of CIA propaganda contaminating U.S. media—"fall-out"—occurs in virtually any instance of propaganda use. The possibility is quite real even when the CIA does not use any U.S. journalist or publication in carrying out the propaganda project. Where a CIA propaganda campaign causes stories to appear in many prestigious news outlets around the world, as occurred at the time of the Chilean elections in 1970, it is truly impossible to insulate the United States from propaganda fallout.

Indeed, CIA records for the September-October 1970 propaganda effort in Chile indicate that "replay" of propaganda in the U.S. was not unexpected. A cable summary for September 25, 1970 reports:

Sao Paulo, Tegucigalpa, Buenos Aires, Lima, Montevideo, Bogota, Mexico City report continued replay of Chile theme materials. Items also carried in *New York Times*, *Washington Post*. Propaganda activities continue to generate good coverage of Chile developments along our theme guidance. . . .²⁸

The fallout problem is probably most serious when the U.S. public is dependent on the "polluted" media channel for its information on a particular subject. When news events have occurred in relatively isolated parts of the world, few major news organizations may have been able to cover them initially, and world-wide coverage reflects whatever propaganda predominates in the media of the area.

Another situation in which the effects of "fallout" in the United States may be significant is that in which specialized audiences in the United States—area study specialists, for example—may unknowingly rely heavily on materials produced by, or subsidized by, the CIA. The danger of this form of dependence is less now than it had been prior to the freer flow of Western travelers to the Soviet Union, Eastern Europe and China.

In its inquiry into the activities of a Vietnamese institution the Committee discovered a particularly unfortunate example of domestic fall-out of covert propaganda activities. The institution was a CIA-inspired creation. The intention of the CIA, according to its own records, was not to undertake propaganda against the United States. Whatever the design, the propaganda effort had an impact on the American public and congressional opinion. The CIA provided \$170,000 per year in 1974 and 1975 for the support of this institution's publications. The embassy in the United States distributed the magazine to American readers, including the offices of all United States Congressmen and Senators. The institution on at least one occasion invited a group of American Congressmen to Vietnam and sponsored their activities on at least part of their trip. Through this institution the CIA—however inadvertently—engaged in propagandizing the American public, including its Congress, on the controversial issue of U.S. involvement in Vietnam.

One particular kind of possible "fallout" has aroused official concern. That is fallout upon the U.S. Government of the CIA's "black propaganda"—propaganda that appears to originate from an unfriendly source. Because the source of black propaganda is so fully concealed, the CIA recognizes that it risks seriously misleading U.S. policy-

²⁸ Chile Task Force Log (R597).

makers. An Agency regulation specifies that the Directorate of Operations should notify appropriate elements of the DDI and the Intelligence Community if the results of a black operation might influence the thinking of senior U.S. officials or affect U.S. intelligence estimates. Regular coordination between the CIA and the State Department's INR has been instituted to prevent the self-deception of "senior U.S. officials" through black propaganda. It should be noted that this procedure applies only to black propaganda and only to "senior U.S. officials." No mechanism exists to protect the U.S. public and the Congress from fallout from black propaganda or any other propaganda.

The Committee recognizes that other countries make extensive use of the international media for their propaganda purposes. The United States public is not insulated from this propaganda either. It is clear, however, that the strongest defense a free country has from propaganda of any kind is a free and vigorous press that expresses diverse points of view. Similarly, the most effective way for this country to respond to the use of propaganda abroad is to permit American journalists and news organizations to pursue their work without jeopardizing their credibility in the eyes of the world through covert use of them.

C. COVERT USE OF U.S. RELIGIOUS GROUPS

The Committee considers religious groups—like academia and the press—to be among the most important of our society's institutions. As such, any covert relationship that might either influence them or jeopardize their reputation is extremely sensitive. Moreover, operational use of U.S. religious organizations differs from the use of other elements of U.S. society. It is a special case, in that virtually all religions are inherently supra-national. Making operational use of U.S. religious groups for national purposes both violates their nature and undermines their bonds with kindred groups around the world.

In its examination of CIA relationships with domestic institutions, the Committee has focused exclusively on the use of U.S. religious organizations.

1. Restrictions on the Use of Religious Personnel

The CIA guidelines issued in the wake of the Katzenbach Committee report required prior approval by the DDO for operational use of any employee, staff member, or official of a U.S. educational or private organization. This restriction applied to operational use of these individuals who were affiliated with American religious organizations. The CIA has provided the Committee with no other regulations that apply specifically to the use of religious groups. In a letter to this Committee, however, Mr. Colby stated that the CIA used religious groups with great caution, and that their use required special approval within the Agency:

Deputy Director for Operations regulations require the Deputy Director for Operations' approval for the use of religious groups. He has the responsibility of ensuring that such operational use avoids infringement or damage to the individual religious personnel involved in their group. Such

use is carefully weighed and approvals in recent years have been relatively few in number.²⁹

On February 11, 1976, the CIA announced:

CIA has no secret paid or contractual relationship with any American clergyman or missionary. This practice will be continued as a matter of policy.

The CIA has assured the Committee that the prohibition against "all paid or contractual relationships" is in fact a prohibition against any operational use of Americans following a religious vocation.

2. Scope of Relationships

The number of American clergy or missionaries used by the CIA has been small. The CIA has informed the Committee of a total of 14 covert arrangements which involved direct operational use of 21 individuals.

Only four of these relationships were current in August 1975, and according to the CIA, they were used only for intelligence collection, or, in one case, for a minor role in preserving the cover of another asset.

The other ten relationships with U.S. religious personnel had been terminated before August 1975; four of them ended within the last five years. In six or seven cases, the CIA paid salaries, bonuses, or expenses to the religious personnel, or helped to fund projects run by them.

Most of the individuals were used for covert action purposes. Several were involved in large covert action projects of the mid-sixties, which were directed at "competing" with communism in the Third World.

3. Issues: "Fallout," Violation of Trust

As several of the relationships—all terminated—involved the religious personnel in media activity, some of the same concerns must be voiced as when U. S. journalists are used covertly. The danger of U.S. "fallout" of CIA propaganda existed in three or four of the relationships with U.S. religious personnel.

The more serious issue, however, is the question of the confidentiality of the relationships among members of the clergy and their congregations.

Of the recent relationships, the most damaging would appear to be that of a U.S. priest serving the CIA as an informant on student and religious dissidence.

Of the earlier cases, one exemplifies the extent to which the CIA used confidential pastoral relationships. The CIA used the pastor of a church in a Third World country as a "principal agent" to carry out covert action projects, and as a spotter, assessor, asset developer, and recruiter. He collected information on political developments and on personalities. He passed CIA propaganda to the local press. According to the CIA's description of the case, the pastor's analyses were based on his long term friendships with the personalities, and the agents under him were "well known to him in his professional life." At first the CIA provided only occasional gifts to the pastor in return

²⁹ Letter from William Colby to the Select Committee, 10/21/75.

for his services; later, for over ten years, the CIA paid him a salary that reached \$11,414 annually.

4. *The CIA and U.S. Religious Organizations and Personnel: Conclusions and Recommendations*

The Committee welcomes the policy, announced by the CIA on February 11, 1976, that prohibits any operational use of Americans following a religious vocation.

The fact that relatively few American clergy or missionaries have been used by the CIA suggests that neither this country's capacity to collect intelligence nor its covert action capability would be seriously affected by a total ban on their operational use. Therefore, the Committee recommends that the CIA's recent prohibition on covert paid or contractual relationships between the Central Intelligence Agency and any American clergyman or missionary should be established by law.

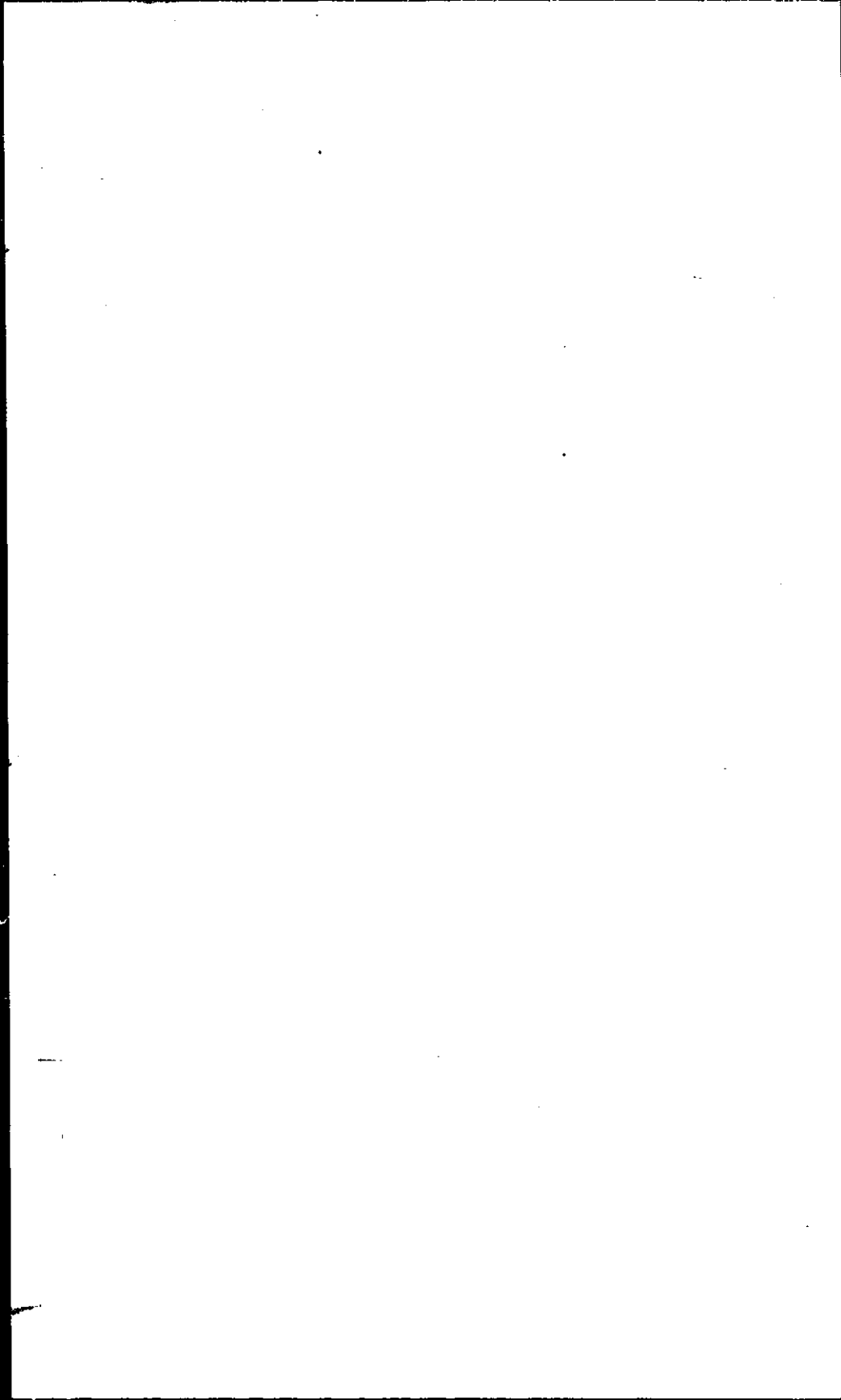

XI. PROPRIETARIES

Proprietaries are business entities, wholly owned by the Central Intelligence Agency, which either actually do business as private firms, or appear to do business under commercial guise. They are part of the "arsenal of tools" the CIA believes it must have to be an effective intelligence component.¹ In recent years, particularly during the Vietnam War, serious questions were raised about this proprietary capability.

Much of the accompanying criticism stemmed from a lack of understanding of the role of proprietaries in both United States foreign policy and the intelligence operations. Some of the criticism arose from the suspected entrance of proprietaries into areas where they would be in competition with legitimate business interests, such as the airline industry. It has been feared that their profits were used to provide secret funding for covert operations, thus avoiding scrutiny by the Executive and the Congress through a "back door" funding process.

In addition, there have been allegations that the domestic impact of these entities has effectively violated the Agency's charter, which generally proscribes domestic activity of a police or internal security nature. Concerns have been expressed that favored treatment has been given these proprietaries by other Government agencies, such as the Internal Revenue Service and the Civil Aeronautics Board. The fact that the size and number of these mechanisms is unknown has caused concern about potentially pervasive influence on the free enterprise system. Questions have arisen about whether Agency policy included using these entities to engage in illegal activities to make profits which could be used to fund clandestine operations. Most notably, the latter charges have involved allegations that the Agency's air proprietaries were involved in drug trafficking.²

Concern has been expressed about the Agency's financial and management control over proprietaries and about the treatment of funds related to such entities.³ It is understandable that there would be misgivings and suspicion, since much that would have explained the role of these proprietaries has remained classified. The Committee has, nonetheless, been able to conduct broad review of these operations. This review has included examination of documents at the CIA, and testimony from present and former Agency employees.

In general, these mechanisms have operated with a proper concern for legality, propriety and ethical standards at the headquarters level. The deviations that have occurred were in the field and generally in

¹ Testimony of Chief of Cover and Commercial Staff (CCS), 1/27/76, p. 20.

² The Committee found no substance to these charges.

³ A careful review has revealed that the CIA's proprietaries are appropriately limited and controlled with careful consideration given to restrict their use within the spirit and letter of the law by headquarters-level personnel.

the area of operators, rather than management personnel. Moreover, the use and past expansion of the proprietaries was a direct result of demands placed upon the Agency by Presidents, Secretaries of State and the policy mechanisms of government. This is particularly true of the large air proprietary complex used to support paramilitary operations in Southeast Asia. The only exception to this pattern is the insurance complex, which was partially established on Agency initiatives to fill a pressing need.

A conceptual problem which continually confronts the intelligence community, applies with full force in the proprietary area. As certain kinds of covert action were developed to deal with the perceived communist threat, the use of certain mechanisms had to be limited. In a totalitarian society for example, governmental and "private" enterprises are essentially one. The government can and does use these entities for intelligence and other official purposes. In our society, however, that which is governmental is generally distinct from that which is private. Traditionally, problems have developed when the government has crossed into the private sector. Proprietaries are no exception to this dilemma. They are, in fact, the embodiment of it.

Thus, the fundamental question presented in this portion of the Committee's inquiry is: can a free and open society tolerate such a confluence of conflicting roles? The Committee concludes that it can, provided that the Congress plays a role in the supervision of these mechanisms to ensure that the delicate balance struck in our society between governmental and private actions is maintained. While there may have been a temptation to view proprietaries as "abusive" *per se*, this attitude was eschewed by the Committee. Although there are potential problems with proprietaries, the Committee feels that aggressive oversight can protect the rights of American citizens and institutions without the need for a ban on the use of proprietaries which serve a legitimate intelligence function.

A. OVERVIEW

Acting under broad authority granted them by the National Security Act of 1947 and Central Intelligence Act of 1949, the various Directors of Central Intelligence have established proprietaries (Government-owned business enterprises, foundations and quasi-business enterprises) to serve a variety of intelligence and covert action purposes. Chief among those purposes have been:

1. *Provision of Cover for Intelligence Collection and Action Projects*

Commercial firms established in foreign countries provide plausible reasons for the presence of CIA case officers. Agency-funded foundations serve as conduits of funds for a variety of purposes, including clandestine activities and contributions to scholars conducting research which supports United States foreign policy positions.

2. *Extension of Agency Influence and Information Network in Overseas Business Community*

The very act of establishing a proprietary firm requires banking, insurance, and other services. Acquiring these services entails support, communications, and intimate business relationships with bona fide

commercial entities here and abroad. At a minimum, these relationships require the clearance of those in top management positions for access to CIA business. On occasion this relationship includes the Agency using commercial contacts for information or assistance.

3. *Provision of Supporting Services for Covert Operations*

In paramilitary operations, airlift and sealift by Agency-owned carriers has many advantages: flexibility, security, ability to implant technical collection devices, etc. CIA agents, who engage in hazardous activities which would ordinarily make them uninsurable, can obtain commercial insurance at standard or subsidized rates via a conglomerate of CIA-owned insurance companies. In foreign locations where actual contact with the nearest CIA station is not operationally discreet, proprietaries provide payroll channels and other administrative services for Agency personnel. Firms based in locations with permissive corporate laws and regulations can also engage in many activities unrelated to their charters. For example, insurance firms can acquire real estate for operational purposes on a non-attributed basis.

4. *Operation of Propaganda Mechanisms*

In establishing the clandestine radios (Radio Free Europe and Radio Liberty) in the 1950s, the CIA acquired a means of directly influencing populations behind the Iron Curtain. These proprietaries were eventually disposed of and placed under the aegis of the Department of State.

5. *Management of Private Investments*

The Agency would deny that private investment is a *purpose* of proprietaries. Agency officials state that standing policy prohibits the investment of CIA operational funds in the private sector without explicit authorization by the DCI. Actually, the existence of proprietary enterprises which occasionally returned sizable profits, indicates that private investment may indeed have been a widespread Agency policy. Moreover, the Agency has specifically authorized its insurance complex to act as an institutional investor for its own funds and those of other proprietaries. Thus, the extent of private investment by the Agency is actually a question of definition and shading.

B. STRUCTURE

Proprietaries fall into two broad categories:

- (1) *Operating* companies which *actually* do business as private firms; and
- (2) *Non-operating* companies which *appear* to do business under commercial guise.

These entities may be legally constituted as corporations, partnerships, or sole proprietorships; or they may have no such legal standing, i.e., they may be "notional" entities financed by the Agency. Corporate proprietaries are incorporated in accordance with the statutory provisions of the jurisdiction of incorporation, are subject to the same review as any corporate entity within that jurisdiction, file applicable state and Federal tax returns, and obtain the necessary licenses to conduct business.

Both operating and non-operating companies serve two purposes: (1) they provide cover, attribution for funding, and administrative assistance to agents and clandestine activities; and (2) they provide services not available through normal commercial facilities. Because these instrumentalities are established as private organizations, they must be organized and managed in accordance with normal business practices and requirements for the types of enterprises they appear to be.

The Agency has generally employed proprietaries when they have been the only way, or clearly the best way, to achieve an approved objective. Under Agency rules proprietaries are established or allowed to continue only so long as they contribute to accomplishment of the CIA's mission, and remain the most effective means to achieve Agency objectives. While current policy does limit the use of operating proprietary mechanisms, the Agency does retain its capability to use these mechanisms, although it limits the size of the actual entities being maintained.

A review of Agency files shows that the number of operating proprietaries has been consciously pared by about 50 percent since the mid-1960s. These reductions were the result of both the Katzenbach guidelines associated with the National Student Association disclosures in 1967, and a survey conducted by the CIA Inspector General in that same year. In addition, the need for proprietaries has declined as a result of: (1) a general shift in emphasis away from covert action; (2) the transfer of Radio Free Europe and Radio Liberty to the Board of International Broadcasting with funding through State Department; (3) the liquidation of the assets of the Air America complex as requirements for CIA support in Southeast Asia diminished; (4) the sale of Southern Air Transport and the liquidation of assets of Intermountain Aviation with their exposure in the press; and (5) a change in the Agency's approach to contingency requirements.

The evidence received by the committee indicates that the activities of all agency proprietaries support the CIA's foreign intelligence collection or covert action missions. Some proprietaries are located within the United States for reasons of operational or administrative necessity, thus there is a domestic infrastructure, but their ultimate impact is overseas. Some of the questionable domestic uses of these entities are detailed in the sections of this Report on "MERRIMAC" and related programs.⁴ In one area, the insurance complex, serious questions remain as to the propriety of using such a mechanism to provide insurance and retirement benefits for agency employees.

1. Operating Proprietaries

Operating proprietaries conduct business in the commercial sphere. While they may compete directly with privately-owned corporations such competition is limited by the agency so that private companies will not be deprived of substantial income. The Agency has been careful to limit the amount of commercial business engaged in by these proprietaries to that necessary to support the viability of the commercial cover. Revenues have been used to partially offset operating costs, and aggregate profits over the years have been relatively

⁴ See the Select Committee's detailed report on CHAOS.

small. Only two proprietaries have shown significant profits: the Air America complex, primarily by fulfilling Government contracts in Southeast Asia; and the insurance company, by handling trust funds and insurance.

Depending upon the functions they perform, operating proprietaries vary in terms of capitalization and total assets. When the commercial purpose of an operating proprietary is incidental to its CIA mission (such as an export-import firm which engages in commercial operations only to the extent necessary to provide cover for a CIA officer in a foreign country) a minimum capitalization, usually in the neighborhood of \$25,000 or less, is all that is required.

Operating proprietaries whose commercial purposes are in themselves essential to the CIA mission require much larger capitalization and investment. They are staffed by Agency personnel and cleared commercial employees. Among the Agency's operating proprietaries of this type are a few management companies and non-operating proprietaries with substantial assets. The Agency's largest operating proprietaries have been Air America, the insurance complex, and Intermountain Aviation, Inc.

Air America, the Agency's largest proprietary, provided air support for CIA operations in Southeast Asia. This support was under cover of a commercial flying service fulfilling United States Government contracts. Corporate headquarters were in Washington, D.C., with field headquarters in Taipei, Taiwan.

The insurance complex provides a mechanism for both the payment of annuities and other benefits to sensitive agents, and self-insurance of risks involved in covert operations. The complex was formed in 1962 as a clandestine commercial support mechanism to provide death and disability benefits to agents or their beneficiaries when security considerations precluded payments which might be attributable to the United States Government. This function was broadened to include assumption of many risks incurred by operational activities. The complex has administered agents' escrow accounts and life insurance, and provided annuity and pension programs for selected agent personnel employed by the Agency. These programs are solely for the purpose of meeting the Agency's obligations to personnel who have rendered services over a substantial period of time, and who are not eligible for normal United States Government retirement programs.

Individuals who qualify for the CIA Retirement System or the Civil Service System are not handled through the proprietary system. The complex has also been used to provide a limited amount of support to covert operations—specifically, for the acquisition of operational real estate and as a conduit for the funding of selected covert activities.

Intermountain Aviation, Inc. provided a variety of nonattributable air support capabilities which were available for quick deployment overseas in support of Agency activities. The assets of Intermountain have been sold, with operations ceasing February 28, 1975, and the corporation is in the process of being dissolved.

The combined net worth (assets minus liabilities) of the operating proprietary companies is approximately \$57.3 million. Although some

are commercially self-supporting, such as those in the insurance complex, most of these companies usually require budgetary support.

Three of these operating proprietaries will be described in the following pages to indicate: why they came into existence; what they did; the management, operations and control environment in which they operated; and what impact they may have had on the private sector. In addition, this discussion will supply the necessary factual reference for the Committee's recommendations. These recommendations reflect the considered judgments of the Committee, which were formulated after hearing the views of current and former CIA employees, and those of other knowledgeable individuals.

The Security Project

In 1958, at the time construction of the new CIA headquarters building in Langley was initiated, a small counterintelligence operation was established to maintain surveillance of the site to prevent hostile penetration and sabotage. It was successful in its objectives and, upon occupancy of the building in 1962, the Security Project was established.

From a single office in Virginia the project expanded to four field offices and grew from a single firm into three separate corporations. The parent organization operated in the greater Washington area. This operating proprietary was a commercial corporation which performed security services on a competitive basis. The firm also conducted operations for the CIA's Office of Security. This operation was successful, with customers utilizing the proprietary for document destruction, consultation, guard work, and security clearance investigations.

This company developed business contracts with agencies of the Federal Government and commercial firms. Because the provisions of the "Anti-Pinkerton Act"⁵ prohibit a company engaged in investigative work from contracting with the Federal Government, the Agency formed a separate company to manage commercial firms as funding mechanisms for investigative work levied by the Office of Security. The new company was headquartered in California. As activity expanded and work increased, a third corporation was organized and headquartered in California.

In early 1966, the original company merged with the third firm, which remained incorporated in the state of California. The corporate officers and the board of directors of all three companies consisted of the same persons. Subsequently, the merged corporation was sold and new legal straw men were introduced as officers, directors and shareholders. In March 1966, a new home office was established in Virginia to enhance administrative efficiency, monetary controls, and cover viability. This "home office," with its investigative charter, has been used to conduct covert investigations.

In addition to conducting investigations, the project was used in the following activities:

- (1) Covert monitoring of construction of CIA headquarters building;
- (2) Monitoring of construction of buildings which were to be occupied by Agency components;

⁵ 5 U.S.C. 8108.

(3) Covert monitoring of construction of CIA printing services building;

(4) Surveillance of Department of Defense civilian employees suspected of being potential defectors to the Soviet Union;

(5) Testing security effectiveness at domestic Directorate of Science and Technology sites and contractor facilities;

(6) MERRIMAC—monitoring of dissident groups in Washington, D.C.;⁶

(7) Hiring and paying contract guards;

(8) Contracting with a civilian firm for the guard force at an installation;

(9) An operation to recruit, process and train undercover internal security agents for the Bureau of Narcotics and Dangerous Drugs;

(10) Security support for Directorate of Science and Technology projects consisting mainly of badging and entry controls, background investigations, and escort of sensitive material—this is the only such activity currently being serviced by the project;

(11) Physical surveillance of an Agency courier suspected of living beyond his means including a surreptitious entry into his apartment;

(12) Physical surveillance of an Agency employee "who maintained contact with people of questionable loyalty" including an audio penetration of the employee's apartment and a mail cover.

Only one office is currently in operation as part of the project. Over the past years, its commercial projects have included badging operations for private companies, i.e., airlines, schools, etc. The company has never made a true profit. To maintain its image among its competitors, however, its books reflect a small profit on which Federal and state taxes are paid. The office presently employs four staff agents, five contract agents and fourteen proprietary employees. During fiscal year 1974, the project expended 2.9 percent of the Office of Security budget.

As noted, this security project has provided the Office of Security and Agency operators support on sensitive covert operations and investigative matters, counterintelligence and counterespionage support for Agency components, custodial support, technical and physical support in surveillances, and Agency proprietary support. The project has also conducted special nongovernmental and sensitive inquiries. Its commercial activities have included: internal security management, security surveys, counteraudio measures and inspection, management of security protective equipment and devices, classified material storage, secure destruction of classified waste, incinerator equipment sales, personnel investigations, and industrial undercover activities.

A unique example of its Agency security function was a project which utilized both security "probes" and security "penetrations." A security probe is a test of the current effectiveness of a security system within an Agency installation. A security penetration is an internal investigation and search which attempts to locate subversive elements at a facility. Such a penetration seeks to detect those who may be en-

⁶This particular project and other aspects of the project's domestic activities are treated in greater detail in the Committee's Staff Report on CHAOS.

gaged in foreign intelligence or sabotage, and those who, by lack of security discipline or gross malfeasance, may be weakening the security structure of the facility. In essence, penetrations are counterintelligence against a domestic installation.

In one instance, an agent was sent under the natural cover of a union construction man to an Agency contractor to gain employment as a pipefitter.⁸ He succeeded in gaining access to the target, and developed information on the installation and its personnel. Similar probes were also conducted against other companies contracting with the Federal Government. The proprietaries which are part of the security project have helped maintain the security required by sensitive Agency operations. Their utility, however, as in the case of nearly all proprietaries is relative to policy demands and "flap" potential. As one Agency commentator phrased it when *Newsweek* revealed the relationship of two Boston lawyers with the CIA in setting up proprietaries:

Proprietaries have been and will continue to be an important tool to achieve selected operational objectives. Their use, however, has been drastically cut back, more because of changes in the international scene and in operational priorities, than as a result of embarrassing exposures.⁹

As has been the case with nearly all other proprietaries, not everyone within the Agency has been satisfied with the existing mechanisms of the security project. There has been constant review, criticism, and internal restraint due to a fear and suspicion that entities which are "out there" may not readily respond to the leash. For example, in June of 1964, the Chief of the Operational Support Division wrote to the Deputy Director of Security (Investigations and Operational Support) concerning project policy and procedures. In terms of operational objectives, he noted that they had "created an operational support entity of dubious capability and with ill-defined objectives or purpose." He suggested that they "look this ugly duckling in the face" and see if it could be terminated gracefully or "see if we can nurture it into a productive and responsible bird of acceptable countenance."¹⁰

The Chief of the Operations Division wrote that he "received the definite impression that there may be some grey area with regard to the internal channels of command and administrative direction." He noted that there was confusion resulting from lack of a clear-cut distinction "at just what level policy matters may be decided . . ." Management procedures for the project were such that "under the current

⁸ He was, in fact, a legitimate tradesman.

⁹ *Newsweek*, 5/19/75, pp. 25-28.

¹⁰ Memorandum from Chief, Operational Support Division to Deputy Director of Security, 6/64.

In many cases these concerns dealt with the inability of the entity to provide adequate cover for itself in order to more adequately fulfill its role. In one instance, the physical backstopping of this project was inadequate. After this was rectified, one official noted:

"It is felt that this step has strengthened the [Corporation's] cover, [in two East coast cities] so that now the company would withstand any inquiries, except that of an official Government investigation."

status everyone may take credit but no one could be blamed." With regard to operational capability he noted:

Quite candidly, I am somewhat concerned about the operational capability of [the] Project. It seems, as a result of its Topsy-like growth, to be oriented toward the military and the building trades. Quite candidly, it is felt that the base must be broadened. Further, I am far from convinced that we have yet developed anywhere near the professional status necessary to "sell" this Project as one having unique operational capabilities sufficient to justify its existence. In other words, I am not impressed with the capability as it now exists nor am I sure that we can sell this product and then be assured that it can perform in a satisfactory manner.¹¹

His comments concerning the attitude of Agency personnel were not unique to this proprietary. They are included here to illustrate the special problems posed by these entities. His remarks also show the dangers inherent in some areas of this activity.

It would seem that this Agency, particularly operating components, are insistent upon pursuing an "ostrich policy" when it comes to their operational security procedures. I have personally witnessed almost hysterical reactions to criticisms as well as total rejections of practical suggestions with regard to operational security procedures. Now it seems to me that we are going about this in a very awkward and embarrassing manner. WE ARE, IN EFFECT, ALLOWING THE WRITERS OF SENSATIONAL BOOKS SUCH AS THE "INVISIBLE GOVERNMENT" TO PROVIDE THE NECESSARY INFORMATION AND PRESURE ON TOP AGENCY MANAGEMENT TO CORRECT GLARING AND STUPID COURSES OF ACTION BEING PURSUED AT THE WORKING LEVEL. I have been the object of considerable personal ridicule due to my stand in opposition to the unrealistic cover and operational security procedures as they relate to certain aspects of [CIA Operational Base] for example. IF we had the *authority* and *capability* to have made an objective probe of this sensitive activity we may have been able to have surfaced these obviously ridiculous procedures in such a manner that corrective action would have been taken. Now is the time to present the case in light of the abiding fear of publicity currently permeating the Agency. I recommend that we go after the authority to make independent (unilateral) probes and/or probes requested and known only at the very highest levels of the Agency with the results discreetly channeled where they will do the most good. There necessarily follows the unpleasant subject of money. As distasteful as it may be, it is no good to have the authority without a sufficiently large confidential

¹¹ *Ibid.*

fund set aside and earmarked for independently initiated activities.¹² [Emphasis in the original]

He emphasized that if the Agency did not take the above kind of action to monitor its "image" at the operational level, it would "continue to be plagued with the unsolicited and uncontrolled critique through the newspapers, periodicals and books." He critically concluded:

Further, I challenge anyone to deny that such exposes to date are largely true and usually the result of our own "ostrich policy" and refusal to face the fact that we have operated in some relatively amateurish manners over the years.¹³

Such concerns have extended beyond these operational levels to general issues of propriety and legality. As noted earlier, the so-called "Anti-Pinkerton Act" prohibited the Office's continued contractual relationship with private companies or their employees for purposes of conducting investigations or providing cover. The General Counsel responded as follows:

I am aware that in fulfilling the responsibilities placed upon your office in support of the Agency's mission, many investigations must be conducted without revealing Government interest. Absent the relationships you question, you could not discharge your responsibilities. It is this inability to accomplish your tasks which causes recourse to the Agency's rather broad statutory authority to expend funds as contained in Section 8 of the CIA Act of 1949, as amended. This authority provides

(a) Notwithstanding any other provision of law, sums made available to the Agency by appropriation or otherwise may be expended for purposes necessary to carry out its functions, including—

(1) personal services, including personal services without regard to limitations on types of persons to be employed, . . .

(b) The sums made available to the Agency may be expended without regard to the provisions of law and regulations relating to the expenditure of Government funds; and for objects of a confidential, extraordinary, or emergency nature, such expenditures to be accounted for solely on the certificate of the Director and every such certificate shall be deemed a sufficient voucher for the amount therein certified.

It is my opinion that this authority permits the Agency to continue the two practices as set out above without fear of violation of the Anti-Pinkerton Statute.^{13a}

He closed, however, with the following admonitions:

There are, of course, other dimensions of the question you raise. As a matter of policy I believe the practices should be reviewed at the highest levels within the Agency and, per-

¹² *Ibid.*

¹³ *Ibid.*

^{13a} Memorandum from General Counsel to Director of Security, 6/64.

haps, cleared with the Agency's oversight committees. In addition, if one of these relationships became public, it must be recognized that there will be allegations that the law has been violated. On balance, it is my view that these considerations are not so significant as to warrant a termination of the two practices with the three companies. It is suggested, however, that any subsequent projected association with a detective company or private investigative company beyond the three present companies be reviewed with this Office prior to its initiation.¹⁴

The Insurance Complex

This proprietary is a complex of insurance companies, most of which are located abroad, operated by the Agency to provide the following services:

- (i) Handling of risks ostensibly covered under commercially issued policies;
- (ii) extending term life insurance, annuities, trusts and workmen's compensation to Agency employees who are not entitled to United States Government benefits;
- (iii) handling escrow accounts for agents; and,
- (iv) limited operational support and investment activities.¹⁵

Origin.—Prompted by the Bay of Pigs losses, the complex was created in 1962 to provide death and disability benefits to agents and beneficiaries when security considerations preclude attribution to the United States Government. Lawrence Houston, retired General Counsel of the Agency, testified that his office established the insurance-investment complex, because his staff was responsible for all problems related to the death or disability of employees during the course of their Agency work. These problems were all handled in what Houston called a very "sketchy way" which he felt was undesirable from all points of view. When the Agency went into air proprietaries on a large scale, additional risks arose which simply could not be underwritten commercially.

So somewhere in the late 1950s or around 1960, I think I was the one that posed that we might organize our own insurance entities.¹⁶

A single event served as the catalyst for the establishment of the complex. Houston recalled in latter testimony that

the event that brought it into focus was the death of four airmen in the Bay of Pigs. These men were not supposed to have engaged in the fighting and were training on the mainland, but when the Cubans were either exhausted or unable to fly anymore, they pitched in, went over the beach, and were shot down.

¹⁴ *Ibid.*

¹⁵ Escrow accounts are established when an agent cannot receive his full payment from the CIA without attracting suspicion. The funds not paid to the agent go into escrow accounts and are invested under the complex.

¹⁶ Lawrence Houston testimony, 1/15/76, p. 61.

We heard of this for the first time the next morning and Allen Dulles called me over and said, you'll have to make some provision for the families of those four fliers

Through [an ad hoc] mechanism we paid benefits to the family for a considerable length of time until we were able to turn it over to the Bureau of Employees Compensation.

This was a very makeshift arrangement, and so based on that I came to the conclusion that we needed a much more formal and flexible instrument. And so after long consideration within the Agency we acquired the first two insurance entities which had been in being before and then we flushed them out a little bit.¹⁷

Thus, the formation of this entity represented the "culmination of experience" in this support area, according to Houston. Although the complex originally operated under the Domestic Operations Division, a special board of directors later assumed control of the proprietaries and their investments. In July 1973 control of the complex was transferred to the Commercial and Cover Staff.

The Current Status.—All of the clients of the project are Agency employees.^{17a} The complex was originally capitalized in 1962 with \$4 million. Most of the assets are held outside the United States and the companies do not write insurance in the United States. Each of the United States companies pays little tax and is audited by a proprietary firm. This method of self-insurance enables the Agency to funnel money where needed in any of its project categories. Currently, 60 percent of the investments are in long-term interest bearing securities abroad, 20 percent in off-shore time deposits in United States banks, and the balance is in common stocks, debentures and commercial paper of various types. In the past twelve years the sale of stocks has resulted in profits in excess of \$500,000 accruing to the CIA. The combined total assets of the complex are in excess of \$30 million, including its retained net earnings of approximately \$9 million.

In 1970 the Inspector General examined the insurance complex. His report raised questions about briefing congressional oversight subcommittees which indicate that Congress had never been informed of the existence or extent of the insurance complex which had grown to an organization with assets of \$30 million without oversight, knowledge, or approval. While annual audits of the complex were conducted, there was no annual allotment and no annual operational review within the CIA, because the insurance activity was no longer a true project after its removal from the Domestic Operations Division.

¹⁷ Houston, 1/27/76, p. 8.

^{17a} The complex itself is only for covert non-staff officers of the CIA. In essence, it only works for what would broadly be described as "agents", those not entitled to participate in the CIA retirement plan or in the Civil Service Retirement Plan. They are primarily foreigners, and usually work for DDO. In the case of most agents, the CIA contributes 7 percent and the agent contributes 7 percent. In keeping with CIA practice for regular employees. In cases where the agent is well along in years and contributions from the Agency and the agent would not provide enough funds to capitalize an annuity, the Agency provides the initial capitalization; however, such an arrangement must be approved by the DDO.

Houston indicated that the complex had been operating "for some time" before

we told our committees any detail. I think it was mentioned as a problem that we had to make arrangements to cope with insurance problems fairly early on. But the fact that it was a business and a business of this substance was not done for some time. My recollection is there was not deliberate avoidance; we just didn't get to it.¹⁸

With regard to buying and selling securities, the Committee sought to discover whether the CIA has any method of preventing personal profit-taking by Intelligence Directorate analysts who have access of clandestinely collected economic intelligence. The CIA has indicated that such an analyst would be in the same conflict of interest position as a staff member of the Securities and Exchange Commission, Department of Agriculture, or any other Government agency for misuse of confidential material. Moreover, financial reporting requirements are imposed upon CIA employees.

Similarly, the Committee attempted to determine whether financial transactions were made by the complex to influence foreign stock markets or currencies. The 1970 review by the Inspector General found no evidence of such influence. Neither did the Committee. All witnesses and documentary evidence indicated that the complex was never so used. Indeed, all agreed that the amounts involved in the fund were insufficient to destabilize any currency or market, even if such an effort had been made.

The complex was subject to an audit in 1974 which concluded that it "continued to be administered in an efficient and effective manner, and in compliance with applicable Agency regulations and directives." Prior audit reports had commented on the need for a revised administrative plan. In accordance with earlier reports, the 1974 audit noted, a "new plan was approved in March 1975." In addition, "minor administrative and financial problems surfaced during the audit were discussed with [project] officials and resolved." The audit noted that *total income* for that year (from interest, premiums, gain or loss on sale of securities, dividends, rentals, professional fees, gain on foreign exchange, gain on sale of property and from miscellaneous transactions) was in excess of \$4 million. The *total expenses* for that year (allocation of premium income to reserve for claims, interest, salaries, rent, accounting fees, taxes, loss on property write-off, legal and other fees, communications, depreciation and amortization, travel, equipment rent, real estate expenses, pensions, due and subscriptions, directors fees, entertainment and miscellaneous) were nearly \$2.5 million. These combined for a net income in excess of \$1.5 million.¹⁹

The current Chief of the Cover and Commercial Staff has focused on the insurance-investment project in a number of interviews with both the Rockefeller Commission and the Committee. He has suggested that the real question for the complex is what its role and shape should be after the termination of many of the Agency's proprie-

¹⁸ Houston, 1/15/76, p. 81.

¹⁹ 1974 Audit of Insurance Complex.

taries. With their liquidation, he believes a reorganization and redefinition of the insurance-investment complex is needed.

As to the issue of a safeguard against misuse of project funds or "insider" information by the Agency, the Chief of CCS has told the Committee that the guarantees against such abuse are (1) compartmentation; (2) the integrity of the Chief of CCS; and (3) display of portfolios to appropriate congressional committees.²⁰

Houston agreed with the three safeguards outlined by the CCS Chief. However, he added a fourth:

When we were investing in stock, I would have the list of stock, the portfolio, reviewed by our contract people, and if I found we had any contract relationship with any of the companies involved, we'd either refuse to—Well, a couple of times our investment advisor recommended a stock which I knew we had big contracts with, and I told the board no, this involves a conflict of interest. We won't touch it. And if we had anything from the Agency contract office that indicated a relationship, we would either sell the stock or wouldn't buy it.²¹

Houston believes that the complex should continue in some form and that the current method, while not perfect, is the best that can be devised. The problem is that the generation of funds for these companies must be demonstrably legitimate and nongovernmental if beneficiaries are to be protected; i.e., the absence of investment by an insurance corporation could well indicate to outsiders that its funding is actually coming from the Federal Government.

Beyond "Doing Business": Peak Non-Government Security Investments by Proprietaries Active as of Dec. 31, 1974.—The insurance and pension complex has sizable investments in both domestic and foreign securities markets. Its portfolio runs the gamut of notes, bonds, debentures, etc. But other proprietaries have also used this investment route as a method of increasing capital and insuring adequate cover.

For example, a domestic corporation purchases general merchandise in a manner which cannot be traced to the United States Government. It provides covert procurement for the CIA Office of Logistics.

While this corporation has no outside commercial business and only five employees, as of December 31, 1974, it had invested over \$100,000 in time deposits. A second domestic corporation purchases arms, ammunition, and police-related equipment for the Office of Logistics. This company has no employees and is managed by Headquarters officials under alias. As of December 31, 1974, this corporation had invested more than \$30,000 in a certificate of deposit.

A travel service proprietary was recently sold to an Agency employee at the time of his retirement. This employee had ostensibly owned the firm, but had in fact managed it for the Agency. As of

²⁰ Chief, CCS, 1/27/76, pp. 15-16.

²¹ Houston, 1/15/76, p. 80.

The current charter for the insurance complex and the administrative plan forbid further acquisition of U.S. stocks and require the divestiture of American equity investments in the immediate future.

December 31, 1974, this corporation had invested more than \$30,000 in a certificate of deposit.²³ An investment proprietary, which was later dissolved, had invested about \$100,000 in Mexico as of March 31, 1973. A Delaware corporation, which has provided secure air support for Agency employees and classified pouches between Headquarters and other Agency facilities in the United States, has nearly \$150,000 invested in a certificate of deposit.

A former youth activity proprietary, in which the Agency no longer retains an interest, had approximately \$50,000 invested in time deposits as of March 31, 1972. Another proprietary is part of a complex managed by the Cover and Commercial Staff which provides operational support for foreign operations. It is a Delaware corporation used to collect proceeds from the sale of Agency proprietary entities and to refund such proceeds to the Agency. Its total assets were nearly three-quarters of a million dollars and its total stockholders equity was in excess of \$15,000 as of December 31, 1973. It has no employees. As of December 31, 1974, it had invested almost half a million dollars in a convertible subordinated debenture from the sale of a company and almost \$50,000 in notes receivable.

Another company in this complex is a foreign company which has been used as an investment vehicle for funds earmarked for new commercial operations requiring Agency investments. This investment project has been terminated and all funds were returned to the Agency. The company has no employees. As of December 31, 1973, it had invested nearly a quarter of a million dollars in a Security Note of a private domestic corporation.

A proprietary which was part of the air support complex had invested over \$200,000 in a certificate of deposit as of December 31, 1974. This entity was later sold. Another is part of the management and accounting complex. As of December 31, 1974, it had nearly half a million dollars invested in time deposits.

The Air Proprietaries

History.—Lawrence R. Houston, former CIA General Counsel, was involved in the establishment of the first set of Agency proprietaries, and has concluded that they should be a mechanism of last resort. Houston maintains that the Agency learned this "the hard way and almost all of the lessons involved probably came out one way or the other in connection with a major aviation proprietary in the Far East. Others had their own special problems, but I think the Air America complex had pretty near everything."²⁴

The Agency acquired Air America in 1949 ostensibly to deny the assets of this company to the Communist Chinese. The CIA first arranged cash advances to the company in 1949. These advances were eventually credited to the Agency's purchase of the corporation. At that time, Houston described the airline as follows:

This normal aviation organization, this would have no meaning at all, was completely at all, it would have no standing

²³ The Agency today uses this firm for the purchase of airline tickets for travel in support of sensitive projects. It is estimated by the Agency that CIA business represents about 30 percent of the gross airline ticket sales of the entity on an annual basis.

²⁴ Houston, 1/15/76, p. 5.

in international law, aviation rights, or any of that. But it worked for what they wanted, which was to take supplies up-country into inland China and then to bring back whatever cargo they could get commercially: tallow, hides, bristles, all that sort of trade, and then they traded that off for their own account. And for awhile the operation was fairly successful, the C-47's and C-46's.²⁵

To finance this activity the lawyer for the airline organized a company, Civil Air Transport, which was funded by a Panamanian corporation. The two owners of Air America approached the Agency in connection with a foreign operation in the spring of 1959, and indicated that unless they received financial assistance, the airline would go out of business.

A series of meetings were held subsequently in which it was determined that the Agency needed to contract for air transport in some of its operations, particularly those involving arms and ammunition.

And so we entered into an arrangement, I think in about September of 1949 whereby we would advance them, the figure of \$750,000 sticks in my mind, against which we could draw for actual use of the planes at an agreed on rate. . . . And we did draw down, I think, all the flying time and expended the \$750,000 between September and about January, at which time we suspended any further payments or draw-downs. I think the money was exhausted.²⁶

The owners came to Washington in early 1950 for a series of discussions with the CIA. As a result of these negotiations, the Agency agreed to advance more funds, and received an option to purchase the assets of Civil Air Transport. Any unused portion of the advances was to be credited toward the purchase price. Air America operated under this arrangement until the owners "came in in the summer of 1950 and said again they were in desperate straits for funds."²⁷ Another series of meetings was held at the Agency in which it was concluded that the operations in the Far East would have a continuing need for secure airlift. There was also a general estimate that the loss of this airlift to the Chinese Communists would substantially assist them. Thus "the Agency then made the decision that they would exercise the option given there was no objection otherwise."²⁸

The Agency felt that it was necessary to obtain approval from the Department of State, so the head of the CIA's Office of Policy Coordination (who was responsible for conduct of covert actions) and Mr. Houston visited the Assistant Secretary of State for the Far East:

He and I went to see [the Assistant Secretary] and explained the situation. And [he] reminded us that it was basic U.S. policy not to get the government in competition with U.S. private industry. But under the particular circumstances, in particular as there was really no U.S. private industry in-

²⁵ *Ibid.*, p. 6.

²⁶ *Ibid.*, pp. 7-8.

²⁷ *Ibid.*, p. 8.

²⁸ *Ibid.*, p. 9.

volved in the area, and they agreed it was important to deny the assets to the Red Chinese. State would go along on the understanding that we would divest ourselves of the private enterprise as soon as such a divestment was feasible, and all of the circumstances that might obtain.²⁹

The divestiture of these air proprietaries was not initiated until 1975, and some of the entities have not yet been fully divested. Mr. Houston noted, however, that :

We did not disregard that guidance because after very considerable use of this asset during the early '50's, there was a question of whether to continue it, and the matter was taken up in the National Security Council. And Allen Dulles, as Director, proposed that we continue the ownership and control of the assets of Air America, as it then was known including the subsidy as needed. And there was a subsidy at that time. . . . It was about \$1,200,000 per year.³⁰

The National Security Council considered whether this asset should be retained in 1956 and, on Dulles' recommendation, decided to continue the subsidy to Air America.

The air proprietary's business consisted almost entirely of Agency cargo carriage under contracts carrying military designations. The company was not organized, according to Houston, to fly common carriage and had no status in the international air business. The evidence indicates that during the early 1950s, there were two internal struggles: one was where control should lie in the Agency, and the other was what policies should apply to the operation of the company itself:

The struggle within the Agency ranged all the way from sort of quiet management discussions as to what was good management, to sometimes rather vociferous arguments of who's in charge here. And the operators always said, "Well, we need to call the shots because it's our operation. . . . And this is what we were running into all the time, of red hot operators opposed to what we would consider good management."³¹

The air proprietary was managed by elements of the Office of Policy Coordination. From the very outset there were problems in this management structure. One such example is the acquisition of Air America in August 1950. Houston was participating in the negotiations at the invitation of the Head of the Office of Policy Coordination.

OPC was a curious organization, determined as being attached to the Agency for quarters and rationing with policy

²⁹ *Ibid.*, pp. 9-10.

³⁰ *Ibid.*, p. 10.

Houston indicated that there had been a subsidy running to the entities since 1949. "\$1.2 million represented about the maximum subsidy given until, I believe, about 1958 was the turning point, and from 1958 on, there was no subsidy as such that went into it." The reason for that, of course, was that the air complex had become "money-making."

³¹ *Ibid.*, pp. 12-13.

guidance from State, which was an impossible situation. Very nice fellows were doing the negotiating with [OPC] . . . quite unknown to me, when they made the agreement to purchase carrying out the option, they gave the vendors the right to repurchase at any time within two years. And I thought this was really inconsistent with our whole position. And during the next two years they negotiated out that repurchase agreement and in its place substituted an agreement to give them a first refusal, if we were to dispose of the airline. That first refusal plagued us for years. They used to make all sorts of extraordinary claims under it and it was never exercised and eventually it was sort of forgotten when [the owners] died. It ran to them personally, whether it ran to them and two others personally, and they all are dead now. But this shows a part of the learning curve, which was the thing we were going through.³²

In the summer of 1954, Houston and a consultant traveled to the Far East to observe the operation. The consultant went "specifically to look at the organization of the airline." At the time of the airline's purchase, the Agency had formed a Delaware corporation to buy it. The corporate counsel and the consultant were both very concerned about the technical organization, or lack of it, in the operation. According to Houston, they demonstrated:

to my satisfaction that it was an absolute situation and that no one out there had the slightest understanding of the problem or what they were up against, or wanted to do anything about it [in terms of airline management].³³

Following this review, a new organization, designed to be more responsive to the Operations Directorate, was created.

Pacific Corporation held title to 40 percent of the equity in Air America, while the remainder was ostensibly owned by Chinese, who gave deeds of trust to the Agency for their shares. For purposes of international law this overt arrangement demonstrated that the company was majority-owned and controlled by Chinese.

Air America originally had several DC-4's and began modest operations between Hong Kong, Taipei and Tokyo. The corporation soon acquired DC-6's, and it was at this time that the question of competition with private corporations first arose. Northwest Orient Airlines was then flying to Tokyo, Seoul, and Manila. A Northwest executive had noted the Agency's interest in this area when he was Chairman of the Civil Aeronautics Board in the late 1940s and early 1950s. Houston told the Committee:

He became head of Northwest, a very tight manager, a very capable fellow, and he used to complain that we were interfering, we were taking passengers off his airline, and we would go to him and say, we have to keep the airline in this business because the Chinese say they need an international airline. They're not ready to start their own yet. And it is

³² *Ibid.*, pp 13-14.

³³ *Ibid.*, p. 17.

necessary to its overall cover status as a going commercial concern.³⁴

By 1959 the executive had decided to ask the Civil Aeronautics Board for a decision. A meeting was held with the entire Board, where the executive maintained "that he was a private industry, he should not be interfered with by government competition."³⁵ The Agency explained its situation, the need for cover, and their efforts to restrict carriage to the minimum necessary to retain their cover.

And it ended up by one of the members of the Board turning to [the executive] and saying, "You ought to be glad that you don't have a really good, reliable competitor in there." He said, "If you were being competed with by private business, you'd have real headaches. You ought to be real glad that it's not worse than it is."³⁶

In these proceedings, Houston conceded that some passengers were traveling on CIA aircraft rather than Northwest planes, but maintained that the impact was minimal and unavoidable. The CAB participated in discussions with both the Agency and Northwest. After hearing both sides, the CAB "came down on the side of the Agency after making a reasoned judgment."³⁷

By 1960 the airline's international commercial business was not making money. Maintenance work in Taiwan, however, was "normally a money-maker, and this was [contracted] primarily, although not exclusively, with the U.S. Air Force."³⁸

There were management problems in the maintenance operation, which originally stemmed from the fact that field personnel were not particularly astute in setting costs for their contracts. Houston cited one instance when the Agency consultant replaced a corporation comptroller who was very able, but "had his own ideas of bookkeeping and controls." The consultant insisted that the corporation implement bookkeeping practices and controls consistent with CAB and FAA regulations. The military maintenance contracts were constantly audited by on-site teams.³⁹

In the early 1960s, the CIA received an exemption from the Contract Renegotiation Board on the grounds that renegotiation personnel might recognize that Air America was not a commercial operation and discover that the CIA was involved. The Agency went to the head of the Contract Renegotiation Board with a letter from the Department of Defense requesting an exemption on what it considered "perfectly legitimate grounds."⁴⁰ There was indeed a basis for exemption under the Renegotiation Act as the business was conducted entirely overseas, and the exemption was granted. The Agency was concerned that it had made a type of profit (over 40 percent on the Air Force maintenance contracts), which may well have been the subject of rene-

³⁴ *Ibid.* p. 21.

³⁵ *Ibid.*, p. 22.

³⁶ *Ibid.* pp. 22-23.

³⁷ *Ibid.*, p. 24.

³⁸ *Ibid.*, p. 25.

³⁹ *Ibid.*, p. 26.

⁴⁰ *Ibid.*

gotiation, had it not been subject to the exemption. "So the question was what to do about it. And finally, we made a voluntary repayment against part of the profit on that contract to the Air Force."⁴¹

As noted previously, the commercial airline aspect of the operation operated mostly at a loss. While there were periods when Air America cargo carriers were very busy on CIA contracts, the Korean War, Diem Bien Phu, and other paramilitary operations; there were also periods between these activities when there was nothing for the airlines to do. During these periods of inactivity, the airline was still saddled with expenses such as crews' salaries and the maintenance of grounded aircraft. To alleviate this problem,

. . . we finally organized the stand-by contract, which was an apparent military entity on Okinawa. It was our entity, but it had a military designation. I can't remember the name for it. And that entity contracted with Air America for so many hours of cargo stand-by to be available any time on call, and that they would pay so much for that capability being maintained . . . so that is how we kept the subsidy going to maintain them during periods when there was not profitable flying.⁴²

Another area of concern was the proprietary's relationship with the Internal Revenue Service. From the outset, the company's management was informed that they would be required to pay appropriate taxes. While there were the usual arguments about whether certain items were appropriate for taxation and whether certain deductions should have been granted, the relationship maintained with the IRS was basically a normal one.

Houston recalled that in the mid-1950s Air America received notice of an upcoming audit by the IRS. Company officials came to the Agency and indicated that this might pose a security problem. The CIA went to the Commissioner of the Internal Revenue Service and indicated that they wished to have the audit conducted by an IRS team on an unwitting basis to see what they could learn. "We thought it would be a good test of the security of our arrangements."⁴³ Later, the IRS personnel would be notified that they had begun to audit an Agency proprietary, and the audit would be discontinued:

They put a very bright young fellow on and he went into it. They came up with discrepancies and things that would be settled in the normal tax argument, corporate-IRS argument, and all of these were worked eventually, and then we went to this fellow and said, "Now, this was owned and backed by the CIA, the U.S. Government. What was your guess as to what was happening?"

And he said, "Well, I knew there was something there, and I thought, what a wonderful asset it would be for the Russians to have, but I came to the conclusion that it was Rockefeller money."⁴⁴

⁴¹ *Ibid.*, p. 27.

⁴² *Ibid.*, p. 29.

⁴³ *Ibid.*, p. 30.

⁴⁴ *Ibid.*

As the operations of Air America developed, problems arose involving large cargo carriers. In the early days of its operation the airline used C-54's, which had an extremely limited range, but were able to perform under demanding circumstances. Discussions proceeded during that period about modernizing the equipment and the Agency, through Air America, bought DC-6AB's. These aircraft were a conversion of the DC-6 with large cargo doors installed. Air America did not maintain any jet equipment at that point.

In the early 1950's Air America became deeply involved in a military Air Transport System. This system was originally known as MATS, and later as MAC.

They got MATS contracts, and Air America got these, and these were very good to keep a constant utilization at a good rate, the MATS rates were usually good, because the policy was not to do competitive bidding for the lowest bidder because then you got the poorest service, but give good rates to the carriers, and then require the carrier belong to the Civil Reserve Air Fleet.⁴⁵

In 1956 MATS changed its policy and required that bidders on their contracts be certified. Because Air America could not become certified, the Agency decided to purchase Southern Air Transport. While this corporation was technically a separate entity, not involved with Air America, it was actually an integral part of the complex from a management perspective. All management decisions for Southern Air Transport were made by the same CIA consultant and advisory team that established Air America policy.

Eventually, MAC decided to require that bidders not only be certified, but that they also have equipment qualified for the Civil Reserve Air Fleet, i.e., jet aircraft. As a result, the Agency acquired Boeing 727's and convinced Boeing to modify the 727 by enlarging the ventral exit, enhancing its airdrop capability.

So the theory was that the 727's would be used on MAC contracts to be available on an overriding basis if needed for major national security operation. They were used, usually when they had spare time. To my recollection, they were only called off once, off the actual contract time, and this was for a possible use which didn't go through. But the White House asked if we had the capability to move something from here to there, I think from the Philippines to somewhere in Southeast Asia. I don't recall, and so they sent word to management that they wanted a plane available at the earliest opportunity at Clark Field. They nulled one of them off the MAC contract and had it available. I think ready to go, in twelve hours, all set for the operation. And the operation was never called. But it showed what the capability was. And what they had to do was get substitute service for the MAC contract.⁴⁶

During the late 1960's several Chinese airlines began operations on a limited scale. With the establishment of these indigenous airlines

⁴⁵ *Ibid.*, 86.

⁴⁶ *Ibid.*, p. 89.

flying Far East routes, the CIA considered reducing its international carriage work. The Agency decided to retain the MAC contracts because they did not compete with the native enterprises, but plans to reduce Air America's international common carriage were initiated.

Another CIA proprietary, Civil Air Transport Company, Ltd., which had been organized in 1954, had been the first Agency entity to engage in common carriage. Later, Air America did the American contracting, followed by Southern Air Transport which also performed MAC and MATS contracts with planes leased from Air America.⁴⁷

Houston noted that in the late 1960s an internal decision was made that:

. . . we probably couldn't justify this major airlift with the big jets, and so we started getting rid of them. See, they had no utilization to speak of down in Southeast Asia. A couple of supply flights went into [another area] and I think we used prop planes for that, to my recollection.^{47a}

So the Agency began to phase out the 727s, which contributed to the decision to divest itself of Southern Air Transport and Air America.

Internal management was streamlined in 1963 by the establishment of an executive committee consisting of the boards of directors of the Pacific Company, Air America and Air Asia. The overt board of directors in New York City passed a resolution organizing an overt executive committee, which consisted of the CIA consultant and two other directors. Covertly, the Agency added its own representatives to this committee, which allowed representatives of management, Agency and the operators to meet, consider policies, and give guidance to the company. Houston indicated that this mechanism was extremely effective in controlling the company:

So I think for the last, oh, fifteen, eighteen years, the proprietary management system was on the whole pretty effective from the Agency point of view. I think we knew what was going on. I think we were able to get things up for decisions, and if we couldn't resolve them at the staff level, we would take them up to the Director for decisions; quite different from the early days in the early 50's that I described, and the operators at least made the claim that they had the right to call the tune.⁴⁸

During this period of time Operations Directorate personnel

were getting themselves involved in the acquisition of aircraft and which were getting awfully damned expensive at this time, and separate projects were going after some of this expensive equipment without consideration of what might be available elsewhere to the Agency by contract or old aircraft. And so the Director of Central Intelligence set up EXCOMAIR, of which I was Chairman, and had representation from both the operation and management and fi-

⁴⁷ SAT actually owned one 727 and leased two from Air America.

^{47a} *Ibid.*, p. 42.

⁴⁸ *Ibid.*, pp. 46-47.

nance out of the Agency, to try and coordinate the overall control and acquisition and disposition of aircraft.⁴⁹

A February 5, 1963 memorandum entitled "Establishment of Executive Committee for Air Proprietary Operations," noted that the committee was "to provide general policy guidance for the management of air proprietary projects, and review and final recommendations for approval of air proprietary project actions." Houston indicated that this committee, dubbed EXCOMAIR, "was . . . an amorphous group" which worked on a very informal basis. He indicated that EXCOMAIR was an effective method of achieving overall coordination; it was responsible for conducting a thorough inventory of all the equipment that the Agency had in the aviation field and was generally able to keep track of who needed what.⁵⁰

According to Houston, a general shift in thinking at the Agency occurred between 1968 and 1972 as to the desirability of maintaining a substantial airlift capability. The records appear to indicate that Houston convinced the Director in the early 1970s that such a capacity was no longer necessary to retain. Houston commented on this assessment as follows:

Through what knowledge I had of the utilization of the various assets, it seemed to me that utilization, particularly of large assets, that is, heavy flight equipment, was going down to the point where there was very little of it. Consequently, we couldn't forecast a specific requirement. Such requirements as you could forecast were highly contingent. But I also remember a couple of times putting the caveat into the Director that with a changing world and with the complications in the aviation field, once you liquidate it, you could not rebuild, and so you ought to think very, very carefully before getting rid of an asset that did have a contingent capability.⁵¹

Allegation of Drug Trafficking.—Persistent questions have been raised whether Agency policy has included using proprietaries to engage in illegal activities or to make profits which could be used to fund operations. Most notably, these charges included allegations that the CIA used air proprietaries to engage in drug trafficking. The Committee investigated this area to determine whether there is any evidence to substantiate these charges. On the basis of its examination, the Committee has concluded that the CIA air proprietaries did not participate in illicit drug trafficking.

As allegations of illegal drug trafficking by Air America personnel grew in the spring and summer of 1972, the CIA launched a full-scale inquiry. The Inspector General interviewed a score of officers at CIA headquarters who had served in Asia and were familiar with the problems related to drug trafficking. After this initial step, the Office of the Inspector General dispatched investigators to the field. From August 24 to September 10, 1972, this group travelled the Far East

⁴⁹ *Ibid.*, p. 51.

⁵⁰ *Ibid.*, p. 52.

⁵¹ *Ibid.*, p. 57.

in search of the facts. They first visited Hong Kong, then eleven Agency facilities in Southeast Asia. During this period they interviewed more than 100 representatives of the CIA, the Department of State, the Agency for International Development, the Bureau of Narcotics and Dangerous Drugs, the U.S. Customs Service, the Army, Air America, and a cooperating air transport company.

This inspection culminated in an Inspector General's report in September 1972, which concluded that there was

no evidence that the Agency, or any senior officer of the Agency, has ever sanctioned or supported drug trafficking as a matter of policy. Also, we found not the slightest suspicion, much less evidence, that any Agency officer, staff or contract, has ever been involved in the drug business. With respect to Air America, we found that it has always forbidden, as a matter of policy, the transportation of contraband goods aboard its aircraft. We believe that its Security Inspection Service, which is used by the cooperating air transport company as well, is now serving as an added deterrent to drug traffickers.⁵²

But there were aspects of the situation in Southeast Asia which were cause for concern:

The one area of our activities in Southeast Asia that gives us some concern has to do with the agents and local officials with whom we are in contact who have been or may be still involved in one way or another in the drug business. We are not referring here to those agents who are run as penetrations of the narcotics industry for collection of intelligence on the industry but, rather, to those with whom we are in touch in our other operations. What to do about these people is a particularly troublesome problem, in view of its implications for some of our operations, particularly in Laos.⁵³

The Inspector General noted that there was a need for better intelligence not only to support American efforts to suppress drug traffic in Southeast Asia, but also to provide continuing assurance that Agency personnel and facilities were not involved in the drug business.

His report began by placing the allegations against the CIA in historical perspective. It allowed that when the United States arrived in Southeast Asia "opium was as much a part of the agricultural infrastructure of this area as was rice, one suitable for the hills, the other for the valleys."⁵⁴

The record before the Inspector General clearly established that official United States policy deplored the use of opium as a narcotic in Southeast Asia, but regarded it as a problem for local governments. It was equally clear that Agency personnel in the area recognized its dangers to U.S. paramilitary operations and "took steps to discourage

⁵² CIA Inspector General's Report, "Investigation of the Drug Situation in Southeast Asia," 9/72, p. 2.

⁵³ *Ibid.*, pp. 2-3.

⁵⁴ *Ibid.*, p. 5.

its use by indigenous paramilitary troops." ⁵⁵ For example, Meo troops were ejected from various camps when they were caught using the drug. But, the I. G. noted:

We did not, however, attempt to prevent its use among the civilian population in those areas where we exercised military control, believing that such intervention would have been resisted by the tribals with whom we were working and might have even resulted in their refusal to cooperate. ⁵⁶

Nor did the Agency interfere with the movement of the opium from the hills to market in the cities farther south. In this regard, the I.G. remarked candidly:

The war has clearly been our overriding priority in Southeast Asia and all other issues have taken second place in the scheme of things. It would be foolish to deny this, and we see no reason to do so. ⁵⁷

Although it maintained this posture, the CIA was reporting information on opium trafficking long before any formal requirements were levied upon it. As far back as the mid-1960s, when CIA case officers began to get a picture of the opium traffic out of Burma as a by-product of cross-border operations, they chronicled this information in their operational reporting. As more information came to light in Laos and Thailand, this information began to appear in intelligence reporting. Indeed, the Agency "had substantial assets [in two Southeast Asian countries, which] could be specifically directed against this target when it assumed top priority in 1971." ⁵⁸

Air America

As early as 1957, Air America's regulations contained an injunction against smuggling. This regulation later came to include opium. The Report indicated that the airline's effort at this time was concentrated on preventing the smuggling of opium out of Laos on its aircraft. Although still not a crime in Laos, shipment of opium on international flights was clearly illegal and was grounds for dismissal of any pilot or crew member involved. The Inspector General stated that:

Air America has had a few cases of this kind (all of which are documented in The files in the Agency) and has, in each case, taken prompt and decisive action upon their discovery. ⁵⁹

Air America was less able to control drug traffic involving its aircraft within Laos. Although it had a rule that opium could not be carried aboard its planes, the only thing that could be done if the rule was violated was to put the opium and its owner off at the nearest airstrip.

⁵⁵ *Ibid.*, p. 6.

⁵⁶ *Ibid.*

⁵⁷ *Ibid.*

The report related a statement of a case officer which typified the CIA position in the matter during the period 1966-1968. The officer said that he "was under orders not to get too deeply involved in opium matters since his primary mission was to get on with the war and not risk souring relations with his indigenous military counterparts by investigation of opium matters."

⁵⁸ *Ibid.*, p. 7.

⁵⁹ *Ibid.*

Moreover, as a charter carrier, Air America did not have full control over its traffic. It hauled what its customers put on the aircraft. Air operations officers, in the case of Agency traffic, were responsible for authenticating the passengers and cargo they wished to put on the plane. In some locations, the air operations officers had to rely on indigenous assistants for much of the actual details of preparing manifests, checking cargo, and supervising the loading of the aircraft. In areas where active military operations were in progress, this process could become cursory if not actually chaotic. In such circumstances, the Inspector General concluded that :

it was hardly fair to blame Air America if opium happened to get aboard its aircraft. There is no question that it did on occasion.⁶⁰

With the realization that drug abuse among American troops in Vietnam was growing and that Southeast Asian heroin was finding its way to U.S. markets, the CIA's early attitude toward the opium problem began to change. The Agency joined the effort that began in 1971 to halt the flow of opium and heroin from Burma, Laos, and Thailand, and pursued a vigorous intelligence program against these targets.

In terms of staff and contract personnel, the Inspector General was impressed that "to a man, our officers overseas find the drug business as distasteful as those at headquarters."⁶¹ Indeed, many of the CIA's officers were restive about having to deal with Laotian officials who were involved in the drug business:

One young officer even let his zeal get the better of his judgment and destroyed a refinery in northwest Laos in 1971 before the anti-narcotics law was passed, thus risking being charged with destruction of private property.⁶²

But, the I.G. reported, CIA officers generally tolerated the opium problem, regarding it as just another of the frustrations one encounters in the area.

From what the Inspector General contingent was able to observe in the field, "the pilots in the employ of Air America and the cooperating air transport company merit a clean bill of health."⁶³ While it was true that narcotics had been found aboard some of their aircraft in almost every case the small quantity involved could only have been for the personal use of the possessor. The Inspector General felt that

Given the strict anti-contraband regulations under which these two airlines have been operating for years, it is highly unlikely that any pilot would knowingly have permitted narcotics or any other contraband aboard his aircraft.⁶⁴

Although they noted, "if it is a truism to say that they're in the business for the money," the investigators concluded that these pilots

⁶⁰ *Ibid.*, p. 8.

⁶¹ *Ibid.*, p. 11.

⁶² *Ibid.*

⁶³ *Ibid.*, p. 12.

⁶⁴ *Ibid.*

were deeply committed to their job, and that the subject of drugs was as much an anathema to them as it is "to any decent, respectable citizen in the United States."⁶⁵

The Inspector General indicated how one pilot felt about the subject. He stated:

You get me a contract to defoliate the poppy fields in Burma, and I'll take off right now and destroy them. I have a friend whose son is hooked on drugs, and I too have teenage children. It scares the hell out of me as much as it does you and the rest of the people in the States.⁶⁶

The report also established that the pilots were well paid, averaging close to \$45,000 a year. Almost half of their salary was tax-free. In this context the I.G. concluded that

Although the temptation for big money offered by drugs cannot be dismissed out of hand, it helps to know that the pilots are making good money. Further, an American living in Vientiane can bank a substantial part of his salary without much difficulty, and a common topic of conversation among pilots is how and where to invest their fairly substantial savings.⁶⁷

The milieu in which these pilots found themselves did serve to evoke images of them as mercenaries or soldiers of fortune. The Inspector General indicated that a "number of them do like their wine and women, but on the job they are all business and very much like the average American."⁶⁸

The investigators, however, could not be as sanguine about the behavior of the numerous other individuals who worked for Air America and the cooperating air transport company: as mechanics or baggage handlers. The nature of their work allowed these employees easy access to the airplanes, and created real opportunities for concealing packages of narcotics in the airframes. The records indicated that there were several instances where employees had been fired because they were suspected of handling drugs. The Inspector General advised that:

Despite the introduction of tighter security measures, it would be foolish to assume that there will not be any further attempts by mechanics and baggage handlers to conceal narcotics on airplanes.⁶⁹

In a startling revelation concerning indigenous officials in Southeast Asia, the I.G. bitterly reported that

In recent testimony to Agency officers in Vientiane, Laotian officials who had been involved in the drug business stated that there was no need for drug traffickers to use Air America facilities because they had their own. We certainly found

⁶⁵ *Ibid.*

⁶⁶ *Ibid.* p. 13.

⁶⁷ *Ibid.*

⁶⁸ *Ibid.* p. 14.

⁶⁹ *Ibid.*

this to be true. In addition to the Royal Lao Air Force (RLAF), there are several commercial airlines in Laos, including Royal Air Lines, Lao Air Development, Air Laos, and perhaps others, all of which evidently have ties with high Laotian government officials. It is highly problematical whether these airlines have a full platter of legitimate business.⁷⁰

Another factor which had the effect of making Air America a less desirable target for the drug trafficker was that there were virtually no regular, pre-arranged flight schedules for the pilots. Ordinarily, the pilot did not know until he reported for duty which airplane he would be flying or what his flight schedule would be for the day.

Air America's Security Inspection Service, which was established early in 1972, also had five inspection units in Laos. Similar units were eventually established elsewhere in Southeast Asia. Each unit consisted of an American chief and three or four indigenous personnel. The baggage of the pilot and all passengers traveling in CIA-owned aircraft was inspected in the presence of an American official before anyone was permitted to board. All cargo was inspected unless it had been exempted under established procedures. The very existence of the system was considered a deterrent to drug smuggling on Air America aircraft and did result in several discoveries of drugs among the baggage of passengers, although only one or two of these involved quantities of sufficient size to be as commercial.

Agents and Assets

This is one area where the CIA is particularly vulnerable to criticism. Relationships with indigenous assets and contacts are always broad. In Laos, clandestine relationships were maintained in every aspect of the Agency's operational program—whether paramilitary, political action, or intelligence collection. These relationships included people who either were known to be, or were suspected of being, involved in narcotics trafficking. Although these individuals were of considerable importance to the Agency, it had doubts in some instances. For example, the investigators were troubled by a foreign official who was alleged to have been involved in one instance of transporting opium. He was evidently considered "worth the damage that his exposure as an Agency asset would bring, although the Station insists (a) that he is of value to the Station as an agent of influence [deleted] and (b) that his complicity in the [deleted] incident has never been proved."⁷¹

Among liaison contacts, which in the military arena included virtually every high-ranking Laotian officer, the Inspector General warned that the Agency was "in a particular dilemma."

The past involvement of many of these officers in drugs is well-known, and the continued participation of many is suspected; yet their goodwill, if not actual cooperation, considerably facilitates the military activities of the Agency-supported irregulars.⁷²

⁷⁰ *Ibid.*

⁷¹ *Ibid.*

⁷² *Ibid.*, p. 18.

The Inspector General concluded, that

The fact remains . . . that our continued support to these people can be construed by them, and by others who might become aware of the association, as evidence that the Agency is not as concerned about the drug problem as other elements of the U.S. mission in Laos. The Station has recently submitted, at headquarters' request, an assessment of the possible adverse repercussions for the Agency, if its relationship to certain assets were exposed. We think that, on the whole, that assessment was unduly sanguine. We believe the Station should take a new look at this problem, using somewhat more stringent criteria in assessing the cost-benefit ratio of these relationships. We realize that it is impossible to lay down any but the most general kind of rules in judging whether to continue, or to initiate, a clandestine relationship with Laotians. Each case has to be decided on its own merits, but within a framework that attaches appropriate importance to its possible effect on the U.S. Government's anti-narcotics efforts in Laos. It is possible that the Station will need additional guidance from headquarters as to current priorities among our objectives in Laos.⁷³

2. Nonoperating Proprietaries

Nonoperating proprietaries vary in complexity according to their Agency task. They are generally corporate shells which facilitate foreign operations and clearly pose no competitive threat to legitimate businesses. The most elaborate are legally licensed and established to conduct bona fide business.

All nonoperating proprietaries do have nominee stockholders, directors, and officers and are generally directed by one of the Agency's proprietary management companies. The company address may be a Post Office box, a legitimate address provided by a cleared and witting company official or private individual or the address of a proprietary management company. The nonoperating proprietaries maintain bank accounts, generate business correspondence, keep books of account which can withstand commercial and tax audit, file State and Federal tax returns, and perform normal business reporting to regulatory authorities. They are moderately capitalized, generally at around \$5,000, and their net worth at any one time varies according to the Agency task they are performing. As of December 31, 1973, more than 60 percent of the combined net worth of these proprietaries was operating capital for companies which provide cover to agency personnel.

Legally incorporated companies require less elaborate commercial administration due to the nature of the tasks they perform for the CIA. This kind of proprietary is directly managed by headquarters specialists operating in alias. No commercial book or accounts are kept, and in the event of a tax audit the Agency has to brief the auditing authority.

Depending on use, administration may be as simple as maintaining bank accounts and filing annual franchise taxes, or as extensive

⁷³ *Ibid*, p. 10.

as that required to obtain Employee Identification numbers, to pay personnel taxes, and to file tax returns.

There are also *sole-proprietorships*, which are proprietaries in the sense of being Agency-owned and administered. The Agency establishes and registers these sole-proprietorships. Arrangements are made to provide an address for these entities. Like the proprietary corporations administered by Agency Headquarters specialists, these companies provide cover, salaries, and tax attribution for Agency personnel.

Another type of entity used by the Agency is a proprietary only in the sense of being Agency-owned and administered. These are the *notional* companies which are not legally registered, but have names and bank accounts controlled by the Agency. The Agency arranges domiciliary addresses and any queries are referred to the Agency specialists concerned. These notional entities are used to provide status and operational cover for Agency personnel involved in all types of high-risk intelligence operations.

C. OPERATION OF PROPRIETARIES

1. Statutory Authority

The Agency's statutory authority to spend money for proprietary corporations in support of Agency operations is derived from Section 8(b) of the CIA Act of 1949. This act states:

The sums made available to the Agency may be expended without regard to the provisions of law and regulations relating to the expenditure of Government funds; and for objects of a confidential, extraordinary, or emergency nature, such expenditures to be accounted for solely on the certificate of the Director and every such certificate shall be deemed a sufficient voucher for the amount therein certified.¹⁴

The language contained in Section 8(b) is adequate authority to exclude the operation of these proprietary corporations from the law governing Government corporations in 31 U.S.C. 841 *et seq.* However, the CIA General Counsel ruled in 1958 that the CIA should comply with the principles in that act to the extent possible, and this has been done. A classified Memorandum of Law by the CIA General Counsel on the Agency's authority to acquire and dispose of a proprietary without regard to provisions of the Federal Property and Administrative Services Act, outlines the CIA's position. This position was upheld by the U.S. District Court in the Southern District of Florida in dismissing the suit *Farmer v. Southern Air Transport* on July 17, 1974.¹⁵ That result was not appealed and remains the law.

2. Specific Controls

The formation and activities of proprietaries are controlled through various mechanisms to assure their proper use. These include internal

¹⁴ 50 USC 408(b).

¹⁵ See p. 246.

Agency regulations which establish the administrative procedures to be followed in the formation, operation, and liquidation of proprietaries. An Administrative Plan (specifying the operational purpose, administrative and management procedures, and cost) and a Liquidation Plan (specifying details of liquidation and disposition of funds when liquidation is contemplated) must be coordinated among the effected CIA components and approved at appropriate management levels. This regulatory control along with policy memoranda are intended to assure proper conduct by proprietaries. Each Agency component involved in the operation of a proprietary enterprise is responsible for compliance. The Chief of the Cover and Commercial Staff, the Director of Finance, and the Comptroller are assigned particular responsibilities.

The controls and procedures applicable to each operating proprietary specify that a project outline and an administrative plan must be approved at the Deputy Director level. Routine control and administration is executed by a project officer at Headquarters. The Agency conducts semi-annual reviews to determine whether operational needs still exist, and performs regular audits to assure proper management and financial accountability. Proprietaries are liquidated as their usefulness ends and new ones are formed as needed.

3. Treatment of Profits

The CIA General Counsel ruled in January 1958 that "income of proprietaries, including profits, need not be considered miscellaneous receipts to be covered into the Treasury but may be used for proper corporate or company purposes."⁷⁶ This subject was reviewed and the opinion reaffirmed by the General Counsel in July 1965. The policy of retaining profits has continued, although only a very few Agency proprietaries have ever been profitable. The CIA's legal basis for retaining profits for the use of the operating corporate entities is discussed below.

Section 104 of the Government Corporations Control Act provides that Congress shall enact legislation necessary to make funds or other financial resources available for expenditure and limit the use thereof as the Congress may determine. It is further provided that "this section shall not be construed as preventing the Government corporations from carrying out and financing their activities as authorized by existing law . . ."⁷⁷ The legislative history explaining this section of the act states that "in cases where no other law required a congressional authorization of expenditures, the corporation, if it had means of financing other than annual appropriations, could continue to operate in the absence of any action by Congress on its budget program."⁷⁸ The statute creating a particular Government corporation may provide specifically how that corporation may use its profits in the conduct of its business.

The Government Corporations Control Act clearly did not contemplate Government corporations of the type that the CIA has established. Furthermore, it is not feasible for Agency proprietaries to be created by act of Congress or overseen precisely as provided for normal

⁷⁶ CIA General Counsel Memorandum of Law, 1/6/58.

⁷⁷ 31 U.S.C. 849.

⁷⁸ Senate Banking and Currency Committee Report 694, 11/2/46.

Government corporations in the Act. Nevertheless, the Agency has felt that the appropriate and reasonable policy would be to treat and control proprietaries in accordance with the terms of the law. The Agency maintains that there is no need to have more restrictive rules applied to its corporations in the use of funds, including profits, than are applied to government corporations under existing statute. Thus, the Agency considers the use by a proprietary of its earnings to carry on its corporate affairs without an offset against Agency appropriations to be a legitimate practice which does not constitute an illegal augmentation of appropriations.

With rare exception, operating proprietaries have not been self-sustaining from real income. Income, including profits, is retained by the proprietaries consistent with the usual operating practices of business enterprises.

The use of proprietaries' profits is controlled by annual CIA reviews and audits of the total capital, investment and profits situations in the context of operational objectives and cover needs of the corporations. The CIA maintains that, in effect, the annual project review is based upon an audit as searching as that required for statutory government corporations. While this may be technically true, such audits do not raise broad questions of program duration and effectiveness. There is no broad management audit in program terms, but rather only a financial audit to determine essential security and integrity. Moreover, there have been no outside audits of any kind, especially those to determine performance and effectiveness. One former CIA employee intimately involved with this process suggested strongly that these provisions were inadequate. This needs to be rectified, and the Committee recommends that such audits be reported to the new legislative oversight committee.⁷⁹

4. Disposition of Funds

Any proprietary with funds in excess of its current or foreseeable needs is required to return such funds to the Agency. Funds generated by the liquidation or termination of a proprietary are returned to the Agency, except in a limited number of situations when they are transferred to another proprietary for "similar use." On the basis of a CIA General Counsel opinion of February 3, 1975, the Agency has revised its policy on the treatment of all returns of funds from proprietaries. All such returns are to be remitted to the United States Treasury as "Miscellaneous Receipts." Prior to this change in policy, returns were treated as refunds of the previously recorded expenses, up to the amount of such expense for a particular proprietary with any excess amounts returned to the Treasury as "Miscellaneous Receipts."⁸⁰

D. THE DISPOSAL OF PROPRIETARIES

1. Overview

The Agency has emphasized the degree to which the extensive proprietary system it has maintained in the past has been disposed of in recent years. According to the current Chief of the Cover and Com-

⁷⁹ See Recommendation 50.

⁸⁰ See Recommendation 52.

mercial Staff, at least as far as large proprietaries are concerned, "because of multitudinous reasons they will be viewed as the solution of last resort."⁶¹ Size was a problem and made it "inevitable that cover would not last." Moreover, there simply is not a need, according to the Agency, for the kind of capabilities supplied by an Air America either now or in the foreseeable future. In this regard, the Agency has also indicated that no "real proprietaries" are in planning because there are no such operational requirements before the Cover and Commercial Staff.

The Committee has learned from its study that the Agency retains the capability "in being" to create large proprietaries.⁶² Moreover, numerous "shelf" corporations are kept available to provide cover. These entities are generally of the notional variety which do not compete with legitimate enterprises. Nonetheless, the Agency has emphasized the need to maintain this general vehicle for at least one purpose: to retain assets. Notionals are a very effective cover mechanism when they are small, and can be very effective in securely providing various support items. In addition, the Chief of the Cover and Commercial Staff told the Committee that, in order to carry out operational functions, the CIA needs a variety of tools:

We need a variety of mechanisms. We need a variety of cooperating personnel and organizations in the private sector.

Proprietaries, in the largest sense as we have used it throughout these investigations, are part of this arsenal of tools that the Agency must have in order to fulfill its job. I said earlier on this morning that on the basis of our experience with proprietaries we have come to the conclusion that wherever possible we try to use other means of providing cover and hiding the CIA hand than proprietaries. But where there is no other way, or where it is the best way in order to achieve the operational objective, we have used proprietaries in the past and we propose to continue to use proprietaries. So we are not getting out of the proprietary

⁶¹ Chief, CCS, 1/27/76, pp. 15-16.

The Deputy Director of Operations noted recently in testimony:

"I think by and large that the day of the big proprietary is over. We have attempted over the past few years to try to squeeze down on those kinds of proprietaries and I think we have really gone now to a fairly small number, and a fairly tightly controlled group of proprietaries who are doing legitimate operational jobs, particularly in the media field.

"Our experience with proprietaries in the past has been if left by themselves, they tend to absorb larger and larger amounts of government money and are not particularly for a business. They are not very viable in the business sense and quickly become suspect as not having any commercial validity. And we have, I think in the past ten years, we have in this past ten years gotten rid of an enormous number of proprietaries in this field. I don't foresee us getting in the immediate future into any expansion of that proprietary record. I think we are about right in terms of where we are now."

⁶² The DDO closed his recent testimony with a caveat:

"I can visualize, however, depending on what happens to the Agency in the future, the possibility that we might want to use more proprietaries, particularly in the field of cover if this gets terribly tight or terribly difficult. But the average operational purpose, except for some of these media operations, all we need is cover and I think that most of the proprietaries that we have fall into that category."

business as such. But it is true that the proprietaries that we are using at the present time and what I can foresee for the immediate future is going to be of a smallish variety.⁶³

The former General Counsel of the CIA, Lawrence R. Houston, concurred in this judgment. It should, he said, be used only as a "last resort."⁶⁴ The Chief of CCS noted that these operations are run for specific purposes unrelated to profit and that, "I am not in the business to make money."⁶⁵

Only two proprietaries, the insurance complex and Air America, returned continuing profits or did large volumes of business. For this reason, the Committee sought to discover if the CIA would ever again seek to establish a large proprietary conglomerate such as the Air America complex. The Chief, CCS responded in this manner:

These kind of facilities, any kind of facilities of this kind get established and are used because they are needed in the pursuit of an existing operational requirement.

If such an operational requirement should again arise, I would assume that the Agency would consider setting up a large-scale air proprietary with one proviso—that we have a chance at keeping it secret that it is CIA.⁶⁶

Mr. Houston noted that he did not believe it was possible to keep such an activity secret:

I'll answer to that. I don't believe it's possible. The aviation industry, everybody knows what everybody is doing and something new coming along is immediately the focus of thousands of eyes and prying questions, and that combined with the intricacies of a corporate administration these days, and the checks and balances, I think make a large aviation proprietary probably impossible . . . I don't think you can do a real cover operation, is my personal assessment.⁶⁷

The Committee reviewed those proprietaries which had been sold or otherwise disposed of during the period from 1965 to 1975. It sought to discover which of those proprietaries disposed of in the last ten years maintained a significant relationship with the Agency by contract or informal understanding. More specifically, the Committee sought answers to the following questions:

- (1) How have proprietaries been disposed of by the Agency?
- (2) Have proprietaries or their assets been sold to persons who had previously served as directors, officers or employees of the proprietaries?
- (3) How often were proprietaries sold pursuant to an agreement or understanding that the purchased proprietary would provide the Agency with goods, services or other assistance?

⁶³ Chief, CCS, 1/27/76, pp. 19-20.

⁶⁴ Houston, 1/15/76, p. 5.

⁶⁵ Chief, CCS, 1/27/76, p. 80.

⁶⁶ *Ibid.*, p. 21.

⁶⁷ Houston, 1/27/76, p. 21.

Our study revealed that during the indicated period, a large number of proprietaries were dissolved, sold, or otherwise disposed of, thus substantiating the Agency's claim that it had moved decisively to extricate itself from this area of activity. In a very real sense, it is nearly impossible to evaluate whether a "link" still exists between the Agency and a former asset related to a proprietary. In some cases, even though formal and informal Agency ties are discontinued, social and interpersonal relationships remain. The impact of such liaisons is difficult to assess.

At its peak, Air America, the Agency's largest proprietary, had total assets of some \$50 million and directly employed more than 5,600 individuals (the total number of employees for the Air America complex was in excess of 8,000). The company is in the process of being liquidated because it is no longer required. The Air America complex included a number of other companies with the Pacific Corporation as the holding company. The general plan for liquidation of Air America is for the Pacific Corporation to sell off Air America, Inc., and its affiliates. A private New York firm was engaged to estimate a fair market value for the complex. Although the Agency conducted an intensive search for competitive bidders, it was able to find buyers for only one of the affiliated companies. The sale of this company was closed on January 31, 1975. The remaining parts of Air America are being liquidated by sale of individual assets upon completion of existing contracts. Funds realized from the sales could be as much as \$25 million and will be returned to the Treasury.

Agency financial support for Radio Liberty and Radio Free Europe, both sizeable proprietaries, was terminated in FY 1971 and responsibility for their funding and operation was assumed by the Department of State.

Southern Air Transport was sold on December 31, 1973 because its contingency capability was no longer needed. The Agency realized \$6,470,000 from this sale, of which \$3,345,000 was in cash (including a \$1.2 million award in arbitration of a dispute over the proceeds of the sale of an aircraft by Southern Air Transport after the sale of the company by the Agency). The purchaser paid the balance to Air America to retire a debt owed by Southern Air Transport. A group of employees of Southern Air Transport filed a civil action disputing the propriety of the sale of the company by the Agency, but the case was dismissed with prejudice on July 17, 1974 by a Federal court.

Most of the entities of which the Agency has divested itself were either sold or given to witting individuals (former officers, employees, managers, contractors, etc.). A handful were sold or given to witting individuals who had no formal relationship with the proprietary. In several cases, transfer of the entity was conditioned as an agreement that the proprietary would continue to provide goods or services to the CIA. Other methods which have occasionally been used to dispose of entities include: merger with another Agency proprietary; transfer or sale of a proprietary to another Government department; and liquidation, with the remaining assets of the proprietary being given to previously uncompensated participants in the venture, or to other Agency proprietaries.

2. The Sale of Southern Air Transport, Inc.

Southern Air Transport Incorporated (SAT) is an American air carrier, incorporated in the State of Florida on October 31, 1949. From its inception until its purchase in 1960 by the Central Intelligence Agency, it was privately owned. It was purchased by the CIA on August 5, 1960, and owned by the CIA through December 31, 1973 when the Agency sold the firm back to one of its original owners.

The decision to acquire Southern Air Transport was triggered by a change in the regulations governing the award of Military Air Transport Service (MATS) contracts. On April 1, 1960, Air America had begun flying a seven month MATS contract operating out of Tachikawa Air Force Base in Japan, to other Pacific locations. In June of 1960, the Department of Defense and the Civil Aeronautics Board changed the regulations governing the awarding of MATS contracts to require that bidders hold at least a Supplemental Certificate of Convenience and Necessity for an air carrier and that they participate in the Civil Reserve Air Fleet Program. Air America did not meet either of these new criteria and could not obtain appropriate waivers.

The Air America heavy airlift capability represented an American asset for use in future operational contingencies throughout the Far East area. Loss of the MATS contract would result in underutilization of aircraft and air crews, and the revenues were needed to sustain these assets. Therefore, the CIA proposed that either Air America should obtain the necessary certification, or that the Agency should buy another commercial firm that already held these certifications. The October 1, 1960 contract date, the need for public hearings, and lengthy proceedings militated against Air America applying for the certificate. In order to avoid lengthy public hearings, which would be time-consuming and generate public exposure, it was decided that the ownership of the company to be acquired must be kept completely separate from Air America. This solution was concurred in by the CAB, DOD, the CIA, and Air America management.

It was anticipated that if the new company were awarded an ongoing MATS contract, it would actually perform the flying service but would use equipment under conditional sale from Air America and would employ personnel transferred from Air America. Under inter-company agreements Air America would provide all maintenance work, ground handling, and other services for which it would be reimbursed by the new company. In this way, Air America would share in the revenues generated by the MATS contracts. The proposal to purchase a supplemental carrier and operate it under the above arrangement was approved by Director of Central Intelligence Allen Dulles on July 15, 1960. Funds from the Clandestine Services budget for FY 1962 were made available for the purchase.

After World War II there had been over 200 supplemental carriers in existence. By 1960 only 18 were still operating. Air America management made a survey of the 18 and determined that Southern Air Transport in Miami, Florida, was the most attractive as a purchase possibility. It operated two C-46s—one owned, one leased—between

Miami and points in the Caribbean and South America. Its associated company owned the four acre property on which SAT was located. Moreover, it operated at a modest profit and had no long term debts.

Negotiations for the purchase of SAT were successful and on August 5, 1960, the CIA exchanged \$307,506.10 for all outstanding shares of capital stock of SAT and its real property owning affiliate. The Agency owned these shares in the name of a former board member of Air America.

Under CIA management Southern Air Transport operated with two semi-autonomous sections: the Pacific and Atlantic Divisions. The Pacific Division performed the MATS contract and supported Agency "heavylift" requirements in East Asia. The Atlantic Division continued to operate in the Caribbean and South America; doing the same sort of flying SAT had done prior to Agency acquisition. The Atlantic Division was also able to furnish support for certain sensitive operations. At the peak of its activities, the SAT fleet, comprised of both owned and leased aircraft, included Douglas DC-6, Boeing 727, and Lockheed L-100 Hercules aircraft.

The Sale

In 1972 it became apparent that the Agency's air capabilities exceeded its needs, and that political realities and future operational requirements in the post-war era of Southeast Asia would not require large air proprietary assets. On April 21, 1972, the Director of Central Intelligence authorized the divestiture of CIA ownership and control of the Air America complex and Southern Air Transport. He approved recommendations calling for: Air America to be retained until the end of the war in Southeast Asia; the immediate elimination of the Pacific Division of SAT; the sale of two 727 aircraft leased to SAT by Air America; and subsequent divestiture of Agency ownership and control of the remainder of SAT.⁸⁸ Specific note was made that conflict of interest should be avoided and that no employee should receive a windfall benefit as a result of these transactions.⁸⁹

In May 1972, two Agency officials met with the Chairman of the Civil Aeronautics Board and his Administrative Assistant to seek informal advice as to the best way to disengage from SAT. Three alternatives were discussed: (1) dissolve the company and sell the assets; (2) sell the assets to the current operators of the company; (3) sell SAT to, or merge SAT into, one of the other supplemental carriers.

The CAB chairman discouraged option (3) because it would involve public hearings and would be subject to criticism by the other supplementals: Option (1), although least troublesome from the legal

⁸⁸ The Director determined that "we no longer should retain air proprietaries purely for contingent requirements and that on the record, therefore, the Agency should divest itself of the Southern Air Transport complex entirely." He stated that the desirable course of action would be dissolution, although he realized that the problems were many and complex. Also, he did not rule out other solutions which might achieve the end and yet better satisfy the interests of all concerned.

⁸⁹ A condition imposed by the DCI was that "in the disposition of any of the assets involved nothing inure to the benefit of Agency employees or former employees or persons whose relationship with the Agency has been or is of such a nature as might raise a question of conflict of interest."

and security standpoints, would further reduce the shrinking number of U.S. supplementals (by 1972, there were only eleven supplemental carriers left) and would be unfair to SAT employees. The CAB officials had no objections to option (2).

On May 5, 1972 the DCI was presented with the results of the meeting with the CAB chairman. He approved the recommendation to explore the sale of the equity in SAT to the current management. It was noted that SAT had been operating as a supplemental carrier for 25 years, that none of the employees of SAT had ever been an employee of the Agency, and that both the Department of Defense and the chairman of the CAB considered it in their best interests to keep SAT as a viable carrier. The rationale behind selling SAT intact to its management was:

(1) Liquidation would deprive the United States of a useful air carrier and would be unfair to the employees.

(2) Sale of SAT on the open market would generate an unacceptable level of public interest and scrutiny. A publicly advertised disposition would run contrary to the Director's statutory mandate to protect intelligence sources and methods.

(3) Although a potential for conflict of interest and windfall profit existed, the sale of SAT to its management would best satisfy the requirements of everyone involved.

The DCI was, apparently, allowed this flexibility in method of disposal by statute. 40 U.S.C. § 474(17) provides that nothing in the regulations relating to disposal of surplus government property shall affect any authority of the CIA. In addition, 50 U.S.C. § 403(d) (5) provides that the Director of Central Intelligence is responsible for protecting intelligence sources and methods from unauthorized disclosure. It was determined that sale of SAT stock to one of its former owners in a confidential manner would prevent damage which could result from disclosure of CIA ownership.

Agency officials began exploring ways in which SAT could be sold to its management, without permitting a windfall to accrue to the buyer, and in a way that could not be construed as a conflict of interest. To establish a reasonable selling price, the Agency asked a Certified Public Accounting firm to perform a valuation study. The accounting firm in turn engaged an aviation consultant firm to conduct an evaluation of the aircraft. The following values were established:

	<i>Millions</i>
(1) Book value of SAT.....	\$3.900
(2) Estimated total value of SAT capital stock on open market.....	2.045
(3) Disposal as going concern.....	2.100
(4) Liquidation value.....	1.250
(5) Agency investment.....	1.500

Based on these figures, the Executive Director-Comptroller on August 17, 1972, approved an asking price of \$2.7 million. Sale at this price to the management would require simultaneous payment in full of the \$3.2 million note payable to Air America through an associated land holding company, and would not include any equity in the lease purchase agreement between SAT and Air America for a Lockheed L 100-30 Hercules aircraft. Although this \$2.7 million price was less than the \$3.9 million book value, it did exceed the fair market value of the company as calculated by professional appraisers. The appraisals were based not on depreciated purchase prices for assets, as

reflected in book values, but on the earning power of the assets adjusted to "present value" and the current resale value for all assets.

On August 23, 1972, the former owner was advised that the asking price for SAT was \$5.9 million; \$2.7 million for the acquisition of stock and \$3.2 million for payment of debt to Air America. A deadline date of October 1, 1972 was established; otherwise the firm would be dissolved and the assets liquidated. Although the former owner contended the asking price should be reduced because the outstanding loan to Air America had been reduced since the date of the study, he stated that he would attempt to work out financing within the deadline date of October 1, 1972. This deadline was extended by the Agency to December 4, 1972.

On December 5, 1972, the former owner submitted an offer to buy SAT for \$5 million: \$1.875 million for the acquisition of SAT and \$3.125 million to pay off the debt to Air America. On December 26, 1972, the Executive Director-Comptroller approved the recommendation that the offer be rejected and that if the former owner was unable to raise by January 20, 1973, the additional funds required for the original purchase price of \$5.9 million, including the Air America debt, that the Agency proceed with liquidation plans and the dismissal of SAT employees not later than February 1, 1973.

On January 11, 1973, a new proposal was submitted to purchase SAT for a total price of \$5,605,000. The former owner cited a tentative commitment for a loan of \$4.0 million and his offer was contingent upon an additional loan. The offer called for a total payment of \$5,605,000 broken down as follows:

	In millions
Acquisition of SAT stock-----	\$2.145
Payment of debt to Air America-----	3.125
Credit for payments to Air America since 10 June 1972 in liquidation of long term debt-----	.335
Total payment-----	5.605

Prior to accepting the offer, CIA officers again discussed the sale of SAT with a CAB representative, who indicated that the board would be interested in seeing SAT continued. The CAB representative stated that it would not be necessary to surface the Agency's name as the true owner of SAT in the CAB proceedings, and that he did not anticipate any problems with other supplemental carriers as a result of the sale.

On January 19, 1973, the DCI approved the sale of SAT. It was noted that the offer was within 5 percent of the original asking price, was above the independent evaluation for sale as a going concern, and was at a figure which would not seem to give the buyer windfall profit. The sale would constitute a clean break-away of SAT from the Agency with the exception of a one year extension on the lease/purchase agreement with Air America for an L 100-30 aircraft. This agreement for sale between the former owner and the Agency included a provision that any profit derived from the sale of assets within one year would constitute a windfall and would be added to the total sale price.

On February 28, 1973, the Board of Directors of SAT executed corporate action on the Agreement for Sale of SAT to the former owner. Closing date was established at not later than 30 days after CAB approval. On March 1, 1973 application for approval of acquisi-

tion of control of SAT by the former owner was filed with the CAB under Docket No. 252-64. It was anticipated that CAB approval would be forthcoming within 60 days.

Subsequent to the agreement for sale and application to CAB, several supplemental carriers generated a great deal of pressure to prevent SAT from being sold to the former owner and to prevent SAT from operating as a supplemental carrier. This pressure was applied through Congressional representatives, the General Accounting Office, and the General Services Administration. The various supplemental carriers objected to the sale of SAT for a variety of reasons. Basically each supplemental objected to the portions of SAT's operating authority which would allow SAT to compete with it. Specifically, representatives of one competitor indicated that it would not oppose the sale if the new owner would voluntarily renounce his rights to Trans-Pacific routes.

Two other companies objected to SAT operating any aircraft as large or larger than a 727 in the Far East. Another objected to SAT bidding on any domestic MAC contracts. Restricting SAT to satisfy all potential competitors could make SAT sufficiently unattractive as a profitable investment that financing would be unobtainable. With this in mind the Agency took the position that agreement for sale of SAT had been executed, subject to CAB approval. If the CAB ruled against the sale and ownership reverted to the Agency, the Agency would cease any bids or service under MAC contracts and dissolve SAT.

Two supplementals expressed interest in buying SAT. One did not make a cash offer, but on June 29, 1973, the other made a cash offer of about \$2 million in excess of what the former owner had offered. According to the Agency, there were compelling reasons not to pursue these offers. Agency officers had reason to believe that the supplementals were not interested in actually buying SAT as they were attempting to secure a commitment from the Agency which could be used to compromise the CIA's position in future CAB hearings. Three reasons for not accepting either offer were:

(1) Any merger with another supplemental carrier would necessitate a very difficult series of CAB hearings during which all other major supplementals would certainly voice loud and strenuous objections.

(2) To sell the firm on a sole source basis to either outside buyer without soliciting public bids would be contrary to sound business practice, and would attract even more adverse publicity.

(3) Both offers were made directly to officials of the CIA and not to the stockholders of record. Although the relationship between the CIA and SAT was the subject of much public speculation, the relationship was still classified and an acceptance of either offer would be a violation of security and cover.

Dissolution of the firm, or sale to the former owner, continued as the most acceptable method of divestiture, subject to CAB approval.

In view of the objections by other supplemental carriers to the sale of SAT to its former owner, and the award by the Air Force of a Logistics Air contract to SAT, the DCI directed on July 31, 1973,

that SAT be dissolved, that it withdraw from the LOGAIR contract and withdraw its application for renewal of supplemental certificate. The former owner was advised of this decision and made a counter offer to purchase the company under his previous offer. He also proposed that SAT return its supplemental certificate, withdraw application for acquisition for sale from CAB, and operate as a commercial carrier under Federal Aviation Regulation Part 121 authority. Such action would remove SAT from direct competition with the supplementals, but retain a worthwhile market in which to operate. Additionally, no CAB hearing would be necessary to obtain this type of operating authority. On October 1, 1973, the DCI agreed to entertain the proposal to continue the sale of SAT as a Part 121 operator, on the condition that the former owner obtain prompt financing. Otherwise, the firm would be dissolved.

On October 5, 1973, the SAT Board of Directors approved and executed a new agreement for sale including the following provisions:

- (1) The former owner to acquire stock of SAT and Actus for \$2,145,000.
- (2) The former owner to pay off \$3,150,000 owed to Air America.
- (3) Agreement subject to the former owner obtaining \$4 million loan.
- (4) Agreement to be subject to SAT withdrawing application for renewal of its Certificate of Necessity and Convenience for an Air Carrier (Supplemental Certificate).
- (5) Lease/purchase agreement for L-100 between AAM and SAT to be extended one year.
- (6) Anti-windfall provision to be effective for one year from date of sale.

On November 29, 1973, the former owner received a commitment from The First National Bank of Chicago for a loan of \$4.5 million thereby making the October 5, 1973 agreement operative. On November 30, 1973, the DCI approved the sale of SAT in accordance with the October 5 agreement for sale. On the same day, the application to the CAB for acquisition of SAT under Docket No. 252-64 was withdrawn and petition for cancellation of certificate and termination of exemption authority was filed with an effective date of December 30, 1973. On December 31, 1973 the sale was closed, the note to Air America was paid off, and the former owner became the sole owner of SAT.

In early January 1974, CIA officials learned from Air America management that SAT had exercised the purchase option of the lease/purchase agreement between SAT and Air America for the Lockheed L 100-30 Hercules aircraft. The option sale price from Air America was \$3,150,000. SAT immediately resold the aircraft to Saturn Airways for \$4,350,000, for a profit of \$1.2 million. The Agency interpreted this sale as a violation of the anti-windfall provisions of its agreement with the owner. On January 25, 1974, Air America executed an Escrow and Arbitration Agreement on behalf of the CIA with SAT on the disputed \$1.2 million profit. The agreement called for \$750,000 to be placed in escrow with the American Security and Trust Company of Washington, D.C. The escrow funds were to be held as a Certificate of Deposit purchased at the prevailing market

rate. It was further agreed that SAT would also place in escrow a Promissory Note to Air America for the remaining \$450,000 of the disputed amount. The note was to bear interest at the same rate currently being earned on the Certificate of Deposit in escrow. It was arranged that the escrow deposits plus accrued interest would be paid to the party deemed in favor by an arbitrator with each party to pay one-half of the costs of arbitration. On September 5, 1974 the arbitrator ruled in favor of Air America. This decision caused an additional \$1,304,243 to accrue to the Agency from the SAT sale. This was the sum of the \$1.2 million under arbitration plus accrued interest, less the Agency's share of arbitration costs.

3. Declassification of Relationship With CIA

In March 1974 the employees of SAT retained an attorney and brought a class action suit in U.S. District Court for Southern Florida against Southern Air Transport, Inc. and the Central Intelligence Agency. The employees as plaintiffs sued for injunctive relief and damages. In this suit the employees alleged:

- (1) That the CIA sold the stock of SAT to the former owner illegally,
- (2) That SAT had embarked on a program to sell off its assets, depriving the plaintiffs of employment,
- (3) That the plaintiffs were entitled to the benefits of the CIA Retirement and Disability System, and
- (4) That their civil rights had been violated.

In view of the publicity arising from the allegations made by the other supplemental carriers during the CAB proceedings and the publicity arising from this suit, it was determined that no useful purpose would be served by continuing to deny the true ownership relationship of SAT by CIA. The operational activities performed by SAT on behalf of CIA were and remain classified. As a part of the Agency's defense in this suit, an affidavit of the Deputy Director for Management and Services of the CIA was presented in court.

In the affidavit he delineated the relationship between the CIA and SAT and the authorities for purchasing and later selling the capital stock of SAT. He also defined the employment status of the plaintiffs as not being government employees and not being CIA employees, and therefore not being eligible for participation in the CIA Retirement and Disability System.

In the Order Granting Motion for Summary Judgment, the court found that the sale of SAT capital stock was not in violation of law; that the plaintiffs' claim to be U.S. Government employees and entitled to CIA retirement benefits was invalid; and that the SAT employees were not deprived of any civil right under any state law. As a result, the action was dismissed with prejudice as to the plaintiff. Although this suit did cause the relationship between the Agency and SAT to be officially disclosed, it did establish, in a court of law, two points favorable to the Agency:

- a. The sale of SAT violated no laws and was within the authority of the DCI; and
- b. The directly hired employees of CIA owned proprietary firms such as SAT do not necessarily enjoy the status of Federal Government employees.

4. Possible Conflict of Interest

In the SAT divestiture, the Agency took precautions to avoid conflict of interest. A retired staff agent who had been the Managing Director of Air America, Inc., made several offers to acquire SAT. In early 1972 he and some other members of Air America management made an informal offer to buy SAT. On August 7, 1972, the retired staff agent told the Agency official responsible for the management of SAT and Air America, that he, in association with two supplementals, wanted to offer "book value" for SAT. He stated that they were not interested in SAT's certificate, but rather in the equipment and that if allowed to make an offer, it would be one that would not require CAB hearings. In both cases, the CIA General Counsel determined that due to the offeror's close association with the Agency, the offer was unacceptable. In later discussions, the retired staff agent asked to be allowed to bid on SAT in open bidding. The General Counsel's position on this request was that open bids would not solve the conflict of interest problems. In any transaction this complex, selecting the bid is only a preliminary to the negotiated final sale.

Another potential conflict of interest involved another supplemental air carrier. From the time the Agency first decided to divest until the sale was consummated, this company expressed continuing interest in merging with SAT. Their representative was a former Director of Central Intelligence, who made literally dozens of phone calls to Agency officials and arranged many meetings; all for the purpose of pressing this company's case to purchase SAT. The company also proposed to arrange "shadow financing" for the former owner of SAT if he would agree to merge at some later time. These offers were all rejected because merger with another supplemental was not an acceptable solution and the apparent conflict of interest was too great.

The sale of SAT to its former owner was another area of possible conflict of interest. While the former owner was not an employee of the Federal Government during any period of association with SAT or CIA, he had been the owner prior to CIA acquisition, and had been nominal president of SAT during Agency ownership. This potential area of conflict had been recognized at the outset of sale proceedings, and the Agency obtained third party professional evaluation and restricted windfall profits to prevent such conflicts. The underlying philosophy for sale back to the former owner was to restore the *status quo ante*, i.e. return of the corporation to its previous ownership once the need for a Government-controlled entity had terminated.

E. FINANCIAL ASPECTS

1. Relations with Other U.S. Government Agencies

Management and control of proprietaries often requires "cooperative interface" with outside agencies to gain beneficial working relationships and appropriate authorizations. These relationships are described briefly below.

For those proprietaries which maintain commercial books and other financial records, commercial managers prepare United States and State tax returns annually, based on the corporation's financial rec-

ords. For other entities where only internal Agency records are maintained, Agency specialists prepare tax returns which reflect normal operations of a legitimate commercial business. The Agency maintains close coordination with the Internal Revenue Service, which is aware of the CIA's use of proprietary commercial entities but not of specific proprietaries' identities. In the event the IRS singles out an Agency proprietary for an audit, the Office of General Counsel notifies IRS of CIA ownership. The IRS then cancels the audit to conserve manpower.

Operation of the air proprietaries has resulted in contact with the Civil Aeronautics Board, the Federal Aviation Agency and the National Transportation Safety Board. Specific problems have been discussed, usually between the Office of General Counsel of the agency concerned and the CIA General Counsel.

The air proprietaries have dealt with State Department and the Agency for International Development, generally on a contractor/customer basis, although senior personnel of those agencies have been advised by the Agency of its ownership of the companies.

Those proprietaries engaged in the shipment of weapons or other items on the Munitions Control list have required CIA assistance in obtaining the necessary export licenses. The ownership of the companies has been discussed with the State Department Office of Munitions Control, and the Bureau of Alcohol, Tobacco and Firearms. While the radio proprietaries were funded by the CIA, they received policy guidance from the Department of State to ensure that their broadcasts conformed to United States foreign policy. The Agency has intervened with the Department of Labor on behalf of survivors of employees of the proprietaries in order to assist them in receiving the available benefits under the applicable Workmen's Compensation Acts. The Agency has also interceded with the Defense Department to have proprietaries' contracts exempted from the Renegotiation Board.

The CIA has requested that the Air Force consider the interests of the Agency in awarding commercial contracts to proprietaries. Initially this was done in the mid-1950s on the basis of a policy decision by the Operations Coordination Board that Air America was an instrument of value to national security. Air America was then operating at a deficit, and the Agency was able to maintain a standby capability without budget subsidies if it could obtain enough business to support large commercial aircraft. Finally, the United States Forest Service was advised of the ownership of a proprietary and asked to award contracts to the proprietary to assist the development of a commercial posture.

2. Magnitude of United States Financial Stakes

Most proprietaries are small-scale operations. In many cases (the notionals), the overseas proprietary actually conducts no business at all; it simply has a commercial charter, staff, and cover arrangements for Agency collection and action projects.

Proprietary income consists of a mixture of CIA subsidy and income. In some cases, the outside income is from sources outside the United States Government income, e.g., Air America received income

for aircraft maintenance of foreign airlines in Southeast Asia. For the most part, proprietary income is in the form of "cross-orders" from CIA and other Government agencies. For example, a CIA paramilitary project placed orders for aircraft engines and pilot services with the Agency proprietary, Intermountain Aviation, Inc., and AID contracted with Air America to carry rice shipments in Laos. In this sense, many proprietaries are analogous to what are traditionally termed "intragovernmental funds" or "industrial funds" in United States Government budget and accounting manuals.

Compared with earlier years, the current size of proprietary expenditures has markedly declined. The potential for future expansion is nevertheless present. Indeed, new proprietaries have been formed within the last several years.

In terms of United States budgetary impact, proprietaries do not add significant new capital to CIA available resources, i.e., while they have a very large expenditure level and momentum over the years, most of these expenditures originated in the CIA and other United States Government appropriations, and the net profits generated by outside business and investment have been relatively small. Another way of interpreting the figures is to observe that nearly half the \$1.6 billion gross income of CIA proprietaries has been supplied by sources outside the CIA.

The Committee reviewed the pattern of income, expense, and net United States investment for the twenty largest proprietaries now active, including their financial experience in the twelve months preceding June 30, 1975. The two largest proprietaries, Air America and the insurance complex, dwarf the rest. While Air America will be phased out by June 30, 1976, ending the CIA-owned airlift capability and returning an estimated \$20 million to the United States Treasury, the insurance complex will continue.

In programmatic terms, the contrast between the current low levels of proprietary activity and the high levels of five years ago reflects the decline of paramilitary operations in Southeast Asia. Large volumes of outside orders by Defense and AID, along with sizable levies by CIA components, and maintenance and passenger income from commercial operations, were generated by a covert war.

Looking toward the future, will new air proprietaries be established? The CIA thinks not, but the matter is not resolved. The ultimate question is whether there will be future United States involvement in covert wars—and if so, can some substitute for CIA-owned air support meet the operational requirements of secure, well-maintained local aircraft? The Chief of CSS suggested that third-country assets could be used instead. Another possibility is the use of United States military aircraft, overtly or "sanitized."

One thing is clear: CIA sees itself as entering a different era of proprietaries. It has rejected the long-held doctrine of "standby" capability, i.e., the notion that it is worth investing considerable capital and operating resources in airlift, sealift, and other assets primarily targeted toward contingency requirements. Agency representatives maintain that the CIA is keeping proprietaries focused on *current* operational tasks. The test of retention is the utility of a proprietary in executing assigned tasks instrumental to approved Agency projects.

Generally, the notionals have increased by about 30 percent since 1967. This reflects a policy of increasing the number of cutout arrangements to increase security, i.e., to reduce one likelihood of outside discovery of agents or case officers working under cover of the end-point notional by introducing intermediate notionals for payments or identity backstops.

What are the basic distinctions of one type of proprietary from another? First, external registration divides the total in half. Those which have some form of legal standing with domestic and foreign corporate regulatory and tax authorities are subject to external governmental scrutiny. This occasions additional expenses and manpower to assure that in all respects this group of proprietaries operates in accordance with local law and commercial expectations. The second group, the notionals, exist only as names on doors, in phone directories, and on stationary. Backstopping for identification of these proprietaries is provided by Agency switchboards, mailstops, and check issuance.

The next level of distinction is within the class of legally registered proprietaries: those which carry on a commercial income-producing operation as contrasted to those which are simply cover arrangements. Within the class of commercial proprietaries which produce income, there is a distinction between those which are wholly dependent upon CIA for income (in the form of orders placed and subsidies) and those which have mixed outside and inside income. Even for those with mixed income, it is possible to distinguish those which have outside income wholly within the United States Government (i.e., a mix of CIA-derived income and income from other Government agencies) from those which have both United States Government income and income from private contracts.

3. *Visibility in the Budget*

Budgetary accountability to the President and Congress depends upon the extent to which the Federal agencies' budget requests provide information to facilitate evaluation. Circular A-11, issued by the Office of Management and Budget, prescribes the financial schedules and explanatory data which all Federal agencies must provide in their budget submissions. These provisions are consistent with the Budget and Accounting Acts of 1920 and 1950. The Central Intelligence Agency regards itself as subject to these prescriptions. The Agency limits the application of this principle to providing only the A-11 materials which OMB and the Congress specifically request. This policy has resulted in near invisibility of proprietaries in the CIA budget submission.

Circular A-11 requires agencies to provide schedules and narratives for each public enterprise or intragovernmental fund. This data is to include all sources of funding purposes and levels of expenditure, and approximate indications of performance through comparisons of past and proposed funding by activity. Under these regulations, it appears that the CIA should have been providing a complete set of schedules for the proprietaries which *actually* do business, i.e., excluding notionals.

The question of the programmatic impact of proprietaries should also be considered. While proprietaries have been heavily involved

in CIA intelligence collection and covert action, these activities have not been reflected in the CIA budget submission. A policy review of the budget requires programmatic judgments of the necessity and appropriate use of proprietaries in overseas areas. The Contingency Reserve Fund is an example of why such clear budgetary information is necessary. Recent debate concerning U.S. involvement in Angola has brought into sharp focus the role of this fund. All United States aid to forces in Angola came from the Contingency Reserve.

The only place in the budgets of the CIA where proprietaries have assumed even a limited visibility is in the years when supplemental financing was needed to establish or strengthen a proprietary. When such financing is necessary, the budget shows, tersely, that Contingency Reserve drawdowns have been made. For example, one past budget showed a certain amount to subsidize Radio Free Europe, but provided no justifying materials. This practice reflects the unwritten, *post hoc* nature of the Contingency Reserve financing process. In effect, these practices allow executive branch "supplementals" in which Congress is informed after the OMB has acted.

The budget does not normally indicate Agency intentions to create a proprietary in the budget year ahead. For any other Federal agency, establishing a new publicly owned enterprise without advance notice to the Appropriations and substantive committees of Congress would be proscribed. Proprietaries which require only small subsidies to get under way are funded by the CIA without supplemental financing, i.e., within its regular budget. Therefore, these proprietaries are completely invisible in the Agency budget submission.

F. SOME GENERAL CONSIDERATIONS

1. *The Relationship of Utility to Size*

The Committee's review revealed a dilemma faced by CIA planners. Proprietaries can sometimes be most effective in operations when they are large; indeed, as in Laos, they may be impelled toward enormity by the very nature of the operation. Yet large size conflicts with deniability. In areas of the world where there are few operating firms, and in types of activity which have only limited commercial appeal, where would large-scale enterprises get financing but from the United States Government? Operations in Laos simply could not be concealed in the end. This experience suggests that proprietaries may have only limited utility in future paramilitary operations.

2. *The Factor of Competition with Private Enterprises*

Do CIA proprietaries which produce income compete unfairly with private United States businesses? Is their utility to the Government of such magnitude that CIA proprietaries should be retained regardless of their competitive impact? Generally, the Agency believes that operating proprietaries do not compete with United States private enterprise because they tend to do things which private companies are not equipped, motivated, or staffed to perform.

For example, CIA proprietaries purchase weapons, foreign armaments, and technical devices; conduct security investigations; purchase real estate; insure uninsurable risks; train foreign police forces; and

run airlines in remote areas or on commercially unattractive routes. Would private enterprise do any or all of these things? It is true that private contracts with the Government include highly sensitive contracts with the CIA for technical intelligence collection, research, and development. Would the abandonment of CIA proprietaries and the cooperation of private firms be more desirable in terms of policy, economy or flexibility?

3. *Relative Scarcity of Commercial and Official Cover*

The continuing CIA desire for more notionals reflects the scarcity of United States Government official cover in many areas of the world, and the developing desire of some United States companies not to cooperate with the Agency.

4. *Profits*

Some questions concerning profits have been raised. Does proprietary profit constitute a significant addition to the resources available to CIA? How is such profit treated in the budget? How is it controlled? How can the Congress (or the President, for that matter) be sure that proprietary profits are not diverted to projects not included in the regular CIA budget?

First, profits (defined as net income to a proprietary after deduction of operating expenses) are relatively small. Even in the days when the most profitable air proprietaries were operating at peak capacity, the most that any single firm netted was less than \$4 million. Over the entire period 1947-1975, total profits have been \$50 million, an average of about \$1.6 million annually, for the 16 biggest CIA proprietaries. And in these years, a net loss was sustained three times—\$2.5 million in 1971; \$0.5 million in 1973; and \$0.3 million in 1975.

Looking to the future, after liquidation of the air proprietaries has been completed, there is forecast to be only one profitable proprietary: the complex of insurance companies which derives most of its profit from investment portfolios. This entity's net income in 1974 was less than \$2 million and a profit of this general magnitude is expected in the foreseeable future. These profits are to be used only for the insurance, escrow, annuity and related complex functions. Neither the complex, nor profits accruing to it, are used for operational support of any other projects or activities. Nevertheless profits from all proprietaries may be reprogrammed into CIA operations due to a "change in policy" reflected in the General Counsel's decision of February 3, 1975.⁹⁰ Thus proprietaries do not presently provide a mechanism for "back door" funding of covert operations; nor are they currently intended to do so.⁹¹

The current Chief of CCS noted that:

It may be the questions that have been raised by the staffs of this Committee and of the House Committee, have kind of energized certain action as far as our Comptroller is concerned, as far as the Office of Management and Budget is concerned, and a methodology is being developed at the present time that the balance sheets of the salient information of

⁹⁰ Chief, CCS, 1/27/76, pp. 80-81.

⁹¹ *Ibid.*, p. 79.

the operation of proprietaries, particularly those that are having earnings, are annexed to the budgetary presentation process and review process, so that this information is available to the Office of Management and Budget, and I assume to Congress, so that this can be taken into consideration.

And you would then have, it seems to me, a degree of safeguard that money cannot be taken out of there and used as an add-on to appropriated funds.⁹²

According to the testimony, from 1973 to 1975, before the opinion was rendered by the General Counsel of the CIA concerning profits and their treatment, the Appropriations Committees were advised that such profits existed, and "it was taken into consideration at the time of appropriations."⁹³

In the future, I would think that any oversight committee could very promptly bring to the attention of the DCI their interest in this question of profit, and ask for an accounting, and certainly could be assured that there was no use of funds derived from a proprietary for an operational purpose unrelated to such activity.

I would think . . . the DCI would be under the same prohibition using funds that were appropriated for the intelligence directorate for operational purposes or any other comparable redesignation of funds.⁹³

When asked whether funds built up in a complex such as the insurance proprietary should be used for purposes beyond those included in an annual authorization, an Agency representative replied:

I would view them as segregated funds to the extent that there was a profit, unnecessary for the purposes of the proprietary, that the profit would have to be turned over to the Treasury and it could not be used for other Agency programs.⁹⁴

As for the treatment in the budget, there are both policy and procedural aspects. The policy of CIA was changed by the February 1975 General Counsel ruling that profits of proprietaries and proceeds of liquidation must be returned to the Treasury as miscellaneous receipts, and cannot be used to augment the Contingency Reserve or otherwise be applied to operations. This ruling overturned the practice of the past which on occasion included the transfer of proprietaries' net proceeds to the Contingency Reserve for later release to operations.

The budgetary presentation and review procedures only partially focus upon proprietary profits. The insurance complex's profits are invisible in the Agency budget; they are taken into account and subject to scrutiny only within CIA. Operationally, the Directorate of Operations' annual review has the most detailed grasp of these monies at the Agency review levels. A standard set of public enterprise fund schedules, as prescribed by OMB Circular A-11, would be appropriate for making this complex visible in the Agency budget. Other commercial proprietaries should show these schedules as well. The Agency has in-

⁹² *Ibid.* pp. 82-83.

⁹³ *Ibid.* p. 84.

⁹⁴ *Ibid.* pp. 84-85.

licated that the Comptroller is working with the Directorates of Operations and Administration to develop more comprehensive budgetary presentation and review procedures for CIA proprietaries.

To what extent can these new procedures prevent abuses of proprietary profits? To what extent do they preclude the need for legislation in this area? What form of Congressional oversight is needed here; at what point should Congress exert control.

Improvement of visibility in the budget of proprietary resources and provision for review of the major proprietaries as a regular part of budget review by CIA, OMB, and Congressional Committees would seem to preclude most of the dangers of abuse. On the other hand, there is one type of abuse for which additional Congressional scrutiny and safeguards may be needed: the possibility of a small-scale, high-risk covert project directed by the President or DCI which is not covered by the regular appropriation but financed by proprietary profits. While no foolproof preventives can be designed by law or regulation, the possibility of such abuse, or the avoidance of congressional review, can be minimized by requiring that all CIA proprietaries report operational activities to the congressional oversight committee.⁶⁵

5. Private Investment by CIA

Two types of general issues are raised by investments made by the Agency:

(1) Should the CIA engage in investments which could accumulate funds outside the budget process and thus be available for operations that have no public scrutiny outside CIA?

(2) Is CIA investment policy too restrictive in regard to bank deposits? Specifically, should the CIA place large amounts of money in commercial banks without drawing interest?

A sizable percentage of the Agency's annual appropriated and advanced funds are deposited here and abroad in commercial accounts on an incremental basis to fund operational needs. If accounts are maintained at levels above the minimum balance necessary for offset costs to the bank, the banks selected earn an interest or investment bonus. The selection of these institutions is non-competitive, rooted in historic circumstance, albeit in institutions that have shown themselves flexible and responsive in providing the Agency services. Further investigation of this area is needed, and we encourage the new oversight committee to study this issue in greater detail than we have been able. This is one area where the exclusion of the General Accounting Office from CIA audits has had an unfortunate effect: there is no outside reviewer of a complex set of financial records and, consequently, confidence in the Agency's role in this area may have been eroded.

6. What is the Future for Proprietaries?

No new proprietaries are in formation or planned. This past fiscal year, 1975, one new proprietary was created which rented office space for an East Coast CIA base and provided cover for Agency employees. The main provision for new growth is the plan of some years standing for establishment in the insurance complex of several corporate

⁶⁵ See Recommendation 50.

"shells" i.e., legally constituted and registered companies that do very little commercial business but which can be adapted to various new CIA missions. To adapt to these new missions, as noted, would require CIA to amend the insurance complex Administrative Plan. But this could be done quickly; the existence of the shells avoids the leadtime of creating new corporate entities, with all the complications of local laws and risk of exposure.

While CIA proprietaries are now smaller than previously, they are so largely for administrative reasons, i.e., response to executive branch directions. Although the CIA may never find proprietary expansion to be operationally desirable, there is currently no statutory constraint on such expansion. Congress should be a partner in the process of reviewing any such expansion by providing for changes in the charter process. Another approach is establishing substantive guidelines for proprietary operation. This approach is typified by the post-Katzenbach guidelines that prohibit CIA operation of tax-exempt foundations.

Lawrence R. Houston, the former General Counsel of the Agency, was intimately involved with all of the proprietaries for his entire tenure with CIA. Consequently, his views have been invaluable to the Committee in reviewing and evaluating the history and the role of these mechanisms. In the course of far-ranging testimony with the Committee on several occasions Houston concluded that proprietaries "should be the last resort for use to backstop Agency activities." He grounded his opinion on the fact that:

they are cumbersome. To be properly run they take many, many man-hours of many, many different parts of the Agency, so they are expensive in man-hours. There are built-in difficulties in running what appears to be a normal business for operational purposes. There's really a built-in dichotomy there that leads to a continual conflict with policies. And due to the number of people involved, there is a security problem on the old grounds that security doesn't go by the mathematical increase in the number of people. It goes geometrically as to the number of people, the security risk.⁶⁶

This assessment appears to be correct based on the evidence reviewed by the committee.

The current Director of Central Intelligence has insisted on streamlining such operations and is keenly aware of the potential for abuse. It is, for example, the current written policy of the Agency that "to the degree that domestic proprietary or cover companies are required, a clear justification will be developed as to the relationship of their support of our overseas operations."⁶⁷

In the one area of continuing large-scale activity, the investment complex, the Agency has moved to insure propriety even in an area where there is no evidence that any illegal conduct has occurred. The current policy, established as of June 1975 is:

[The project] will be operated in conformance with appropriate legal restrictions. Arrangements are being made for the

⁶⁶ Houston, 1/15/76, p. 4.

⁶⁷ Memorandum of the DCI, 6/75.

briefing of the appropriate Congressional committees. Particular attention will be given to avoiding any possible conflict of interest situations with firms with which the Agency has contracts. Particular concern will also be exhibited over possible improper influence on the stock market or stock dealings through the investments involved in [the project].⁹⁸

The Committee is mindful of the potential danger inherent in such operations. Therefore, it recommends that the review of this and other similar projects by the appropriate oversight Committees be most stringent.

The disposal of proprietaries has also generally proceeded along legal and ethical lines with more than due concern for conflicts of interest. Most notable in this spectrum of actions was the degree to which the Agency avoided conflicts of interest in the sale of Southern Air Transport. Such internal vigilance no doubt should and will continue. Moreover, with the establishment of a permanent oversight committee, the CIA's reporting will be made easier because it will be able to report on its dealings on a regular basis to informed Members of Congress.

⁹⁸ *Ibid.*

XII. CIA PRODUCTION OF FINISHED INTELLIGENCE

The main purpose of the intelligence system of the United States is to provide the President, his chief advisers, and the Congress in appropriate ways with the best information about activities abroad that can be obtained. It is not surprising, therefore, that the quality of finished intelligence produced by the intelligence agencies has been a source of continuing concern and controversy. Policymakers are understandably seldom satisfied with the intelligence they receive, for they want and need intelligence which eliminates uncertainties and ensures successful policy decisions. Since such perfection is unattainable, however, the realistic question is how to evaluate and improve the quality of our finished intelligence. This is an extremely complicated and difficult area. The simple answer is that there are no objective criteria or standards that can be universally applied. In the end, the assessment by policymakers of the value and quality of our finished intelligence is necessarily subjective. There is a record of steadily improved quality over the years, but the need for a higher level of performance is accepted, both at the policy level and among the intelligence agencies of the U.S. Government.

The Committee's examination of the production of finished intelligence focused on the CIA and within it, the Directorate of Intelligence (DDI). This is by no means the whole of national intelligence, but it is the core element in the production of finished national intelligence. The CIA's Directorate of Intelligence is by far the best analytical organization for the production of finished intelligence within the Government, but it does have shortcomings. The CIA for its part has, in the view of the Committee, made creditable efforts to improve the quality of finished intelligence, although much remains to be done.

Because the provision of the best possible fact and predictive analysis to our policymakers is the most important mission of our intelligence system, the problems of the production of finished intelligence will require the most searching and systematic examination by a future oversight committee. The preliminary work of the Select Committee in this area is based on interviews and hearings, as well as documents from the Intelligence Community Staff concerning their post-mortems of past intelligence failures. Because of the complexity and difficulty of the subject matter, the examination of the Select Committee can only be regarded as a beginning, only broadly indicative of the problems involved, and suggestive of the areas which will require more thorough and comprehensive attention in the future.

Although the provision of intelligence analysis to policymakers is the major purpose of the intelligence mission, the production of intelligence has been referred to as the "stepchild of the community."¹ It is an area which has been overshadowed by the glamour of clandestine activities and the lure of exotic technical collection systems. Yet

the basic rationale for intelligence operations is the provision of information to the people who need it in order to do their jobs—the President and other senior officials responsible for the formulation and implementation of foreign policy.

The Pearl Harbor experience, which so heavily influenced the establishment of the Central Intelligence Agency in 1947, pointed to the need for the collection, coordination, and analysis of all national intelligence in a centralized fashion, so that policymakers could be assured of receiving all the information they needed, when they needed it. Finished intelligence represents the “payoff” of investment in the plethora of collection activities.

The CIA and its predecessor body, the Central Intelligence Group, were established to rectify the duplication and biases that existed in the intelligence production of the State Department and the military services. By reviewing and analyzing the data collected by these departments, the CIA was to provide senior government officials with high-quality, objective intelligence. In practice, however, the CIA has given precedence to independent collection and production, becoming a competing department in the dissemination of information.

Historically, the departments resisted providing their data to the Agency and thereby prevented the CIA from fulfilling its designated role in the production of “coordinated” intelligence. Moreover, individual Directors of Central Intelligence have not been consistent advocates of the Agency’s intelligence production function. For the DCIs, the demands of administering an organization with thousands of employees and in particular, the requirements of supervising clandestine operations encroached on the intended priority of intelligence production. Only three DCIs attempted to address their primary attention to the quality of intelligence production: Walter Bedell Smith, John McCone, and James Schlesinger. In each case, the DCI’s attitude was a function of his background, his relative strength as Director, and the particular demands of his time in office.

In recent years, however, and particularly with the introduction of advanced technical collection systems, the requirement for bringing together the vast quantities of information into useable analytic forms has become the primary concern of the intelligence community.

In the course of its investigation, certain problems and issues in the area of the production of finished intelligence in the CIA have come to the attention of the Committee. The Committee believes these problems deserve immediate attention by both the executive branch and future congressional oversight bodies. These problems bear directly on the priority given to finished intelligence by policymakers. Other issues raised here, such as the personnel system of the DDI and the organizational structure of intelligence production, are really functions of the larger issue of priorities.

Briefly defined, the production of intelligence is the process whereby the data collected by the intelligence community is transformed into intelligence reports and studies that are relevant to the concerns of senior policymakers. Intelligence production involves many tasks. It begins with the collation and evaluation of incoming “raw” intelligence reporting—direct from the collectors, whether from open sources, the clandestine service, or signals intercepts and other means

¹ Office of Management and Budget, “A Review of the Intelligence Community,” 8/10/71, (hereinafter cited as the Schlesinger Report), p. 11.

of technical collection. The significance of new reporting is analyzed, often in relation to intelligence already available on the subject. The preparation of "finished" intelligence reports—the outcome of the production process—thus entails the evaluation and analysis of the full range of raw reporting from a variety of collection means.

Production of finished intelligence is done within the intelligence community by the Central Intelligence Agency, the Defense Intelligence Agency (DIA), and the State Department's Bureau of Intelligence and Research (INR). Within the CIA (which is responsible for the production of "national intelligence"), both the Intelligence Directorate and the Directorate of Science and Technology (DDS&T) produce finished intelligence. The Select Committee has focused on the DDI, although the issues and problems cited are applicable in varying degrees to the other production elements as well.

A. EVOLUTION OF THE CIA'S INTELLIGENCE DIRECTORATE

The scope of the DDI mission is global. It covers the affairs of any foreign country from the standpoint of politics, economics, defense, geography, cartography and biography. Scientific reporting is largely the responsibility of the Directorate of Science and Technology.

The Directorate of Intelligence was formally established on January 2, 1952. Specifically, the intelligence activities which the DDI originally administered were:

a. Production of finished intelligence by the Offices of National Estimates (ONE), Current Intelligence (OCI), Research and Reports (ORR), and Scientific Intelligence (OSI).

b. Collection of essentially overt information by the Divisions of the Office of Operations (OO): Foreign Broadcast Information (FBID), Foreign Documents (FDD), and Contacts (CD).

c. Dissemination, storage and retrieval of unevaluated intelligence information and basic reference documentation by the Office of Collection and Dissemination (OCD).

d. Coordination of intelligence collection by the Office of Intelligence Coordination (OIC).

In the twenty-three years since its founding, the Intelligence Directorate has gone through a number of reorganizations stimulated by advice from external panels, changing international circumstances, shifting requirements for finished intelligence production, and reduced resources with which to perform its mission.² Changes in the first few years were fairly rare. In 1954, the OIC was abolished, and in 1963 the Office of Scientific Intelligence was transferred to a new Directorate for Science and Technology.

1. Intelligence Production

Estimative Intelligence.—Producing National Intelligence Estimates (NIEs) was the function of the Office of National Estimates

²The information contained in this section on the evolution of the DDI is derived primarily from a CIA paper prepared for the Select Committee by the Office of the DDI, "The Directorate of Intelligence: A Brief Description". (Hereinafter cited as "The Directorate of Intelligence.") December 1975.

which was in the Intelligence Directorate until 1966, when it became a staff under the direction of the Director of Central Intelligence. This move was made, in part, to emphasize that the NIEs were the product of the entire intelligence community rather than a single agency. ONE was abolished in 1973 and its responsibilities were transferred to the newly formed National Intelligence Officers attached to the Office of the DCI. With this move, much of the work of producing draft estimates reverted to the production offices of the Intelligence Directorate.

Current Intelligence.—Primary responsibilities for producing current intelligence remains where it has been since the Directorate was established—in the Office of Current Intelligence. Originally, OCI was responsible for all current intelligence reporting except economic. At present, however, it concentrates on current political reporting, leaving the preparation of reports on economic, military, geographic and scientific developments to the research offices responsible for these matters. OCI coordinates and consolidates this specialized reporting on all subjects for presentation in its daily intelligence publications.

Basic Intelligence.—Production of basic intelligence was stimulated primarily by the realization in World War II that the U.S. Government had too little information about many of the foreign countries with which it was required to deal. The Basic Intelligence Division (BID) or ORR was charged with responsibility for coordinating the production of "factual intelligence . . . of a fundamental and more or less permanent nature on all foreign countries." Because of the scope of the subject matter, the production of this type of intelligence required a cooperative effort involving the resources and capabilities of several departments and agencies of the Federal Government. The product of this government-wide effort was known as the National Intelligence Surveys (NIS).

In 1955, BID became a separate office, the Office of Basic Intelligence (OBI). This was in line with recommendations made in May 1955 by the Task Force on Intelligence Activities.³ The elevation of Basic Intelligence to Office status was an acknowledgment of the importance that the Agency and the rest of the national security apparatus attached to the NIS Program.

The early years of OBI were devoted mostly to the coordination of this program. Many of the chapters were written by other elements of CIA or by other government agencies on a contractual basis. In 1962, OBI took over responsibility for the production of the political sections of the NIS from the State Department's Bureau of Intelligence and Research where State claimed that it no longer had the resources to do this work. OBI delegated the task of producing these sections to OCI in 1962. In 1965, the geographic research function was transferred from the Office of Research and Reports, creating the Office of Basic and Geographic Intelligence (OBGI). The NISs continued to be published until 1974 when the program was terminated because of lack of resources. At this time, OBGI became the Office of Geographic and Cartographic Research.

Military Intelligence.—Until the mid 1950's, the production of intelligence on military matters had been considered the primary respon-

³ The Clark Task Force, headed by Gen. Mark Clark, of the Hoover Commission. For members of the task force, see Hearings, Vol. 4, p. 112-13.

sibility of the Department of Defense. But the "bomber gap" and later the "missile gap" controversies gave CIA a role in foreign military research, an involvement which has continued and expanded. In 1960 the DDI created an *ad hoc* Guided Missiles Task Force to foster the collection of information on Soviet guided missiles and to produce intelligence on their manufacture and deployment. The Task Force was abolished in 1961 and a Military Research Area was established in ORR. As a result of increasing demands for CIA analysis of military developments, a new Office of Strategic Research was established in 1967 by consolidating the Military-Economic Research Area of ORR and the Military Division of OCI. The scope and focus of responsibilities of OSR have increased over the years and in 1973 a new component for research in Soviet and Chinese strategic policy and military doctrine was added.

Geographic Intelligence.—The Geographic Research Area (GRA) of the Office of Research and Reports (ORR) originally had the responsibility for geographic intelligence production. The GRA was transferred in 1965 to the Office of Basic Intelligence changing its title to the Office of Basic and Geographic Intelligence (OBGI). In 1974, OBGI became the Office of Geographic and Cartographic Research when the National Intelligence Survey (NIS) Program was abandoned.

Economic Intelligence.—Activity in this area remains the responsibility of the organization that succeeded the Office of Research and Reports in 1967: the Office of Economic Research. In earlier years, the Agency concentrated its economic research largely on the Communist states. In recent years, however, the Department of State has dropped much of its intelligence production on the non-Communist areas, leaving this job to the Agency. OER has also expanded its research into such subject areas as international energy supplies and international trade. Today it is the largest research office in the Intelligence Directorate.

Biographic Intelligence.—The Hoover Commission Report of 1949 recommended dividing the responsibility for biographic intelligence production within the Community to prevent costly duplication. As a result, the foreign political personality files maintained by OCD were transferred to State. In 1961, however, the Bureau of Intelligence and Research claimed it no longer had the resources to provide this service and the responsibility for reporting on foreign political personalities and, subsequently, for all non-military biographic intelligence reporting was transferred to CIA. The task was taken over by OCD's successor organization, now the Central Reference Service.

In-Depth Political Research.—In-depth foreign political intelligence reporting has not been, until recently, represented in the Office structure of the Intelligence Directorate. Originally, whatever efforts were made in this field were concentrated in OCI. In 1962, a modest step toward increased foreign political research was taken with the establishment of a Special Research Staff (SRS) in the Office of the Deputy Director for Intelligence. In recent years, however, the diminished role of State's Bureau of Intelligence and Research in intelligence community affairs, a perceived need for more sophisticated work in this field by CIA, and the appearance of new methods of political re-

search, including computer applications, encouraged the Directorate to invest more resources in this area. Accordingly, an Office of Political Research (OPR) was established in 1974. It incorporated the Special Research Staff, some people from OCI and the then disbanding Office of National Estimates.

Round-the-Clock Watch/Alert.—The Cuban Missile Crisis of the fall of 1962 clearly spotlighted the need for a single Directorate facility for round-the-clock receipt of intelligence information and for a center in which the expertise of all its offices could be rallied in crisis situations. In March 1963, the DDI set up a Special Study Group on DDI Organizational Tasks to study this and other problems. One of the results of its work was the establishment of an operations center under the administrative direction of the Office of Current Intelligence (OCI). Over the next ten years, the Operations Center grew in size and capability, largely as a result of the Vietnam War. In 1974, it was separated from OCI and renamed the CIA Operations Center, a title warranted by the fact that all Directorates of the Agency now maintain permanent duty officers within the Center. Today, the CIA Operations Center provides the mechanism and facilities with which the full information resources of CIA can be mobilized to work in concert with the community in foreign crisis situations.

2. Intelligence Collection

At its founding in 1952, the Intelligence Directorate inherited the Office of Operations (OO) from the then Directorate of Plans—today's Operations Directorate. OO was composed of three main elements: the Contact Division, the Foreign Broadcast Information Division, and the Foreign Documents Division. The rationale for including these components in the Intelligence Directorate was that their work was essentially overt and thus inappropriately situated within the Clandestine Service.

The Domestic Contact Service originated in the Central Intelligence Group in 1946 as an outgrowth of the World War II effort to insure that all domestic sources of information on foreign activities were contacted by the Government. It was initially placed in OO to keep its essentially overt work separate from the clandestine activity of the other major collection organizations. It maintained this separate status after the founding of CIA, but in 1951 joined the Directorate of Plans. This arrangement lasted for only one year, however, as the OO and its Contact Division (CD) was moved to the Intelligence Directorate in 1952. By 1953, CD was a network of offices in 15 major cities and several smaller residencies established across the U.S. With the abolition of OO in 1965, CD became an independent office known as the Domestic Contact Service (DCS) and continued in that status until the appointment of William Colby as DCI. In 1973, he decided that maintaining the separation of overt and covert collection elements was less important than the goal of consolidation of all human collection capabilities in the Operations Directorate. Accordingly, the DCS was transferred to the Clandestine Service and renamed the Domestic Collection Division.

The Foreign Broadcast Information Division (FBID) had been founded by the Federal Communications Commission in 1940. With the advent of World War II, it was absorbed by the Office of War

Information and, shortly thereafter, became one of the original elements of the OSS. At the end of the war, it was briefly administered by the Department of the Army before joining the Central Intelligence Group in 1946. It was formally included in the Agency's Directorate of Plans at its founding in December 1950 and remained there as part of OO until its transfer to the Intelligence Directorate in 1952. By then it had established the worldwide network of broadcast monitoring bureaus which—with some alterations in location—it operates today. FBID received the status of an independent office and was renamed the Foreign Broadcast Information Service with the dissolution of the Office of Operations in 1965.

3. Information Processing

Between the collection and production phases of the intelligence process there is an activity known as "information processing." Information processing involves special skills or equipment to convert certain kinds of raw information into a form usable by intelligence analysts who are producing finished intelligence. It includes things like photointerpretation and translations of foreign documents as well as the receipt, dissemination, indexing, storage, and retrieval of the great volumes of data which must be available to the production offices if they are to do their analytical work.

Information Dissemination, Storage and Retrieval.—One of the original offices of the Central Intelligence Group, the Office of Collection & Dissemination (OCD), began this work in 1948 when it introduced business machines to improve reference, liaison and document security services. Ultimately, this Office became CIA's own departmental library and centralized document service. Its steady growth in size and capabilities was given a boost in 1954, when responsibility for the procurement of foreign documents was transferred to OCD from the Department of State. Other specialized collections also became a part of the holdings of that office, including those of motion picture film and photography. The systems of storage and retrieval developed by OCD were unusually effective for that time and the Office began to gain recognition throughout the intelligence community. In 1955, OCD was renamed the Office of Central Reference to more accurately reflect its Agency-wide responsibilities. In 1967, OCR was renamed the Central Reference Service (CRS). Today, CRS can offer intelligence analysts throughout the community some of the most sophisticated information storage and retrieval systems to be found anywhere in the world.

Photographic Interpretation.—CIA's work with photographic interpretation began in 1952 and was initially centered in the Geographic Research Area, ORR. In 1958, a new Photographic Intelligence Center (PIC) was created by fusing the Photo Intelligence Division of ORR with the Statistical Branch of OCR. The new Center was given office-level status and the responsibility for producing photographic intelligence and providing related services for CIA and the rest of the Intelligence Community. In 1961 PIC was further elevated to become the National Photographic Interpretation Center (NPIC). This Center was staffed by former members of PIC and DIA personnel detailed to NPIC. All personnel were functionally under the Director, NPIC, who continued to report to the DDI.

An interagency study conducted in 1967 concluded that NPIC's national intelligence responsibilities had grown so substantially that departmental imagery analysis requirements were not being adequately served. Accordingly, the DDI established an Imagery Analysis Service (IAS) as a separate office of the Directorate to deal exclusively with the photo intelligence requirements of CIA. In 1973, it was decided that NPIC would be more appropriately placed in the Directorate of Science and Technology with other elements dealing with reconnaissance at the national level.

Translation Services.—The Foreign Documents Division (FDD) of the Office of Operations (OO) had its origin in the Army and Navy's Washington Document Center. Founded in 1944, it was a repository for captured Japanese and German records. It was absorbed by the Central Intelligence Group in 1946 and, during the late forties, evolved from a repository into an exploiter of all foreign language documents coming into the community. It joined the Central Intelligence Agency as part of OO in the Directorate of Plans. With the transfer of OO to the Intelligence Directorate in 1952, FDD continued to expand its work into the field of document exploitation, concentrating increasingly on materials received from the communist countries. In 1964, it was separated from OO to become part of the Office of Central Reference (OCR). This arrangement lasted only three years, however, as FDD was transferred again to become part of FBIS in 1967. The intent of this move was to combine the Directorate's efforts to exploit foreign media—radio and press—in a single service and to concentrate its major assets in terms of foreign language capabilities. FDD remains in FBIS to this day, providing translation services for the Agency, the community, and to a lesser degree, for the Government and the general public.

DIRECTORATE OF INTELLIGENCE

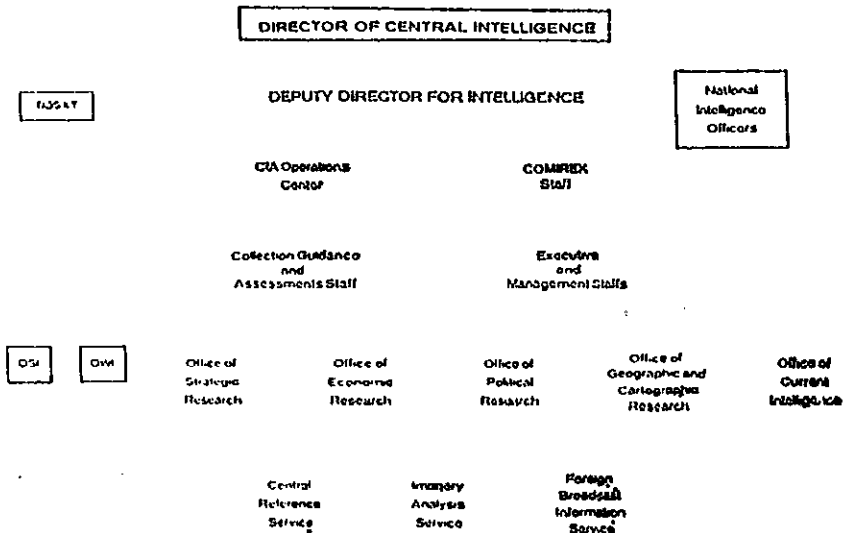

B. THE INTELLIGENCE DIRECTORATE TODAY

In FY 1976, the DDI had a relatively small share of the Agency's budget and personnel. Resources allocated to intelligence production have represented a relatively steady percentage of the intelligence budget over the years. Intelligence production is a people-intensive activity, requiring relatively little in the way of supplies, equipment, structures, and operational funding. The Intelligence Director spends approximately 75 percent of its budget on salaries. Of the positions in the DDI, 74 percent are classified as professional and 26 percent as clerical. Of the total, 54 percent are directly involved in "intelligence production" (researching data, analyzing information and writing reports), 28 percent are tasked with "intelligence processing" (performing reference and retrieval functions, preparing publications, or providing other support services), and 18% are involved in "intelligence collection" (monitoring overt foreign radio broadcasts and publications).⁴

The most important group of DDI products consists of the daily intelligence publications, designed "to alert the foreign affairs community to significant developments abroad and to analyze specific problems or broadly-based trends in the international arena."⁵ These include the *President's Daily Brief*; the *National Intelligence Daily*, prepared for Cabinet and sub-Cabinet level consumers; and the *National Intelligence Bulletin*, distributed more broadly to the defense and foreign affairs communities. The DDI issues a number of weekly periodicals on specialized subjects, prepared in the research offices of the directorate.

The DDI also produces in-depth and analytical studies on a periodic or one-time basis. These are monographs on particular problems; some are DDI-initiated, others respond to specific requests of the policymakers or their staffs. In addition, DDI analysts usually provide the bulk of the staff work for the National Intelligence Estimates (NIEs), which are prepared under the auspices of the National Intelligence Officers (NIOs).⁶

The Intelligence Directorate also performs a variety of coordinating and analytical services in providing intelligence support to policymaking. Most National Security Council (NSC) meetings begin with an assessment of the current situation given by the DCI, and prepared by DDI analysts. The DCI, similarly supported by DDI personnel, also participates in an array of interagency policy groups (e.g., the 40 Committee, the Senior Review Group, the Washington Special Action Group, and the Strategic Arms Limitation Talks [SALT] Verification Panel). The DCI's representatives are involved in lower-level interdepartmental groups, including geographic area groups, functional area groups, and ad hoc groups.

Analysts from DDI frequently contribute to the preparation of National Security Study Memoranda (NSSMs), which are usually

⁴ "The Directorate of Intelligence," p. 4.

⁵ *Ibid.*, p. 2.

⁶ *Ibid.*, p. 2.

drafted by interagency groups under the direction of the NSC staff. Often a NSSM will include an intelligence assessment of the problem at hand as an annex to the memo itself; this might also be summarized in the text.

Three examples illustrate how the DDI contributes such intelligence support. A SALT support staff has been assembled in CIA to coordinate SALT-related activities of production offices in the DDI and DDS&T. The staff serves as the point of contact to respond to intelligence requirements generated by the NSC staff, the Verification Panel, and the U.S. SALT delegation. The staff relies on the analytical offices of the CIA for substantive intelligence.

In another case, after the 1973 Middle East war, the DDI was asked to examine all aspects of possible Sinai withdrawal lines on the basis of political, military, geographic, and ethnic considerations. Eight alternative lines were prepared for the Sinai, a number of which Secretary of State Henry Kissinger used in mediating the negotiations between Egypt and Israel.

Finally, the DDI provided assessments to the policy groups who prepared U.S. positions for the Law of the Sea Conference in 1975, including descriptions of the strategic straits under discussion, analysis of each country's undersea mineral resources, and information about political positions the participating countries would be likely to take.⁷

THE ISSUES

The Select Committee began its examination of intelligence production by considering the relationship between intelligence and policy, and the limits of intelligence. These considerations served to highlight certain problems in production which the Committee feels deserve further attention by both the executive branch and congressional oversight bodies. These problems bear on the key issues of quality, timeliness and relevance of finished intelligence. They derive in large part from the nature of presidential leadership and the particular emphasis and preoccupations of successive Directors of Central Intelligence. In the past, the national leadership has used the CIA more for operational purposes than for its analytic capabilities. Other concerns derive from the structure of the analytical personnel system, the intelligence culture and the nature of the intelligence process, the overload of the system, the preoccupation with current events, and the lack of sufficient quality control and consumer guidance and evaluation.

C. THE RELATIONSHIP BETWEEN INTELLIGENCE AND POLICY

The relationship between intelligence and policy is a delicate and carefully balanced one. One witness told the Select Committee that there is a "natural tension" between the two and that

if the policy-intelligence relationship is to work, there must be mutual respect, trust, civility, and also a certain distance. Intelligence people must provide honest and best judgments and avoid intrusion on decisionmaking or attempts to influence it. Policymakers must assume the integrity of the intelli-

⁷ Staff summary of briefing given by Edward Proctor (DDI), 4/24/75.

gence provided and avoid attempts to get materials suited to their tastes.⁹

In recent years there has been a tendency on the part of high officials, including Presidents and Secretaries of State, to call for both raw reporting and finished intelligence to flow upwards through separate channels, rather than through a centralized analytical component. This has resulted in many cases in consumers doing the work of intelligence analysts. Presidents and Secretaries of State have all too often relished the role of "crisis managers", moving from one serious issue to another and sacrificing analysis and considered judgment in the pressure of events. In between crises, their attention is turned to other pressing matters, and careful long-range analysis tends to be set aside.

By circumventing the available analytical process, the consumers of intelligence may not only be depriving themselves of the skills of intelligence professionals; they may also be sacrificing necessary time and useful objectivity. In making his own intelligence judgment based on the large volume of often conflicting reports and undigested raw intelligence instead of on a well-considered finished piece of intelligence analysis, a high official may be seeking conclusions more favorable to his policy preferences than the situation may in fact warrant.

The essential questions about the intelligence product concern its usefulness to the policymakers for whom it is intended. Does intelligence address the right questions? Does it deliver the kinds of information and insights policymakers need in order to make foreign policy decisions? Is it timely? Is it presented and disseminated in the manner and format most useful to the consumers? Will they read it in other than crisis situations? The answers to these questions are by no means simple. Still, the Select Committee believes they are deserving of examination—and periodic reexamination—in the interests of maintaining an effective intelligence service.

While intelligence analysts have a very good record in the area of technical assessment (e.g., hard data on foreign military hardware), the record is weaker in qualitative judgments, trend forecasting, and political estimating. While analysts may be able to furnish fairly complete and reliable reporting on tangible factors such as numbers and make-up of Soviet strategic missile forces, they are not as good at assessing such intangibles as why the Soviets are building such a force. The problem pertains to other issues, too, for example, in analyzing the likely negotiating stance of a particular country in economic negotiations of interest to the United States.

In particular, some policymakers feel that intelligence analysts have not been especially helpful to policymakers on the more subtle questions of political, economic, and military intentions of foreign groups and leaders. The view from the top is, of course, very different from the view held by analysts in the departments and agencies or in the field. Too often analysts are not willing to address such questions directly. Analysts tend to believe that policymakers want answers instead of insights. Some consumers argue that intelligence analysts lack sufficient awareness of the real nature of the national security

⁹ John Hulzenga testimony, 1/20/70, p. 14.

decisionmaking process—how it really works, where and how intelligence fits in, and what kinds of information are important.⁹

On the other hand, the Select Committee is concerned that analysts are not always kept sufficiently informed, in a timely fashion, of U.S. policies and activities which affect their analyses and estimates. The Committee is concerned that the secrecy and compartmentation surrounding security policy decisionmaking affects the relevance and quality of intelligence analysis. The analysts in the DDI may not always be aware of what a key foreign leader has told high-level American policymakers in private, and so they may be missing crucial information on a particular nation's intentions in a given situation.

The Select Committee's study of covert action has revealed that on a number of occasions in the past intelligence analysts were not told what U.S. covert operators were doing abroad, an omission which could seriously affect the accuracy of intelligence assessments. Likewise, because of security compartmentation, DDI analysts sometimes did not know about particular U.S. strategic weapons R&D programs, and so were not able to assess completely the reasons for countermeasures that were being taken in the development of Soviet strategic forces.

D. THE LIMITS OF INTELLIGENCE

Clearly what is needed is a realistic understanding by both producers and consumers about the limits of intelligence: what it can and cannot do. As a former senior analyst explained to the Select Committee,¹⁰ what intelligence *can* do is to follow the behavior of foreign leaders and groups over a long period of time in order to get a sense of the parameters within which their policies move. American policymakers are not then likely to be greatly surprised by foreign behavior—even though intelligence analysts might not be able to predict precise intentions at any given moment with respect to a given situation. Nor can analysts be expected to predict human events when often the actors themselves do not know in advance what they will do. As the Schlesinger Report said:

In a world of perfect information, there would be no uncertainties about the present and future intentions, capabilities, and activities of foreign powers. Information, however, is bound to be imperfect for the most part. Consequently, the intelligence community can at best reduce the uncertainties and construct plausible hypotheses about these factors on the basis of what continues to be partial and often conflicting evidence.¹¹

To expect more may be to court disappointment. Despite this recognition on the part of many policymakers, if analysis is not correct, there is often the charge of an "intelligence failure." Good intelligence or accurate predictions cannot insure against bad policy, in any case. For example, as the current Deputy Director for Intelligence maintains, the pessimistic CIA estimate on Vietnam had little or no effect on U.S. policy decisions there. Vietnam may have been a policy failure.

⁹ Staff summary of Andrew Marshall interview, 2/10/70.

¹⁰ Hutzenga, 1/26/70, p. 24.

¹¹ Schlesinger Report, p. 10a.

It was not an intelligence failure.¹² Similarly, the United States had intelligence on the possibility of a Turkish invasion of Cyprus in 1974. The problem of taking effective action to prevent such an invasion was a policy question and not an intelligence failure.

E. THE PERSONNEL SYSTEM

To some extent, problems in the quality of the analytical performance of the intelligence community are simply in the nature of things. The collection function lends itself to technical and managerial approaches, while the analytical job is more dependent on the intangibles of brainpower. In the final analysis, the intelligence product can only be as good as the people who produce it.

The CIA prides itself on the qualifications of its analysts. The Agency's exemption from Civil Service constraints—unlike the DIA, for example—has enabled the DDI to attract the best analysts in the community. Nevertheless, those in the highest positions in the CIA have traditionally come from the operations side of the Agency.

The Agency's promotion system is structured in such a way that the most outstanding lower-level people are singled out for advancement into managerial positions. Such a system works well for the purposes of the Directorate of Operations (DDO), where the skills necessary for good management are essentially the same as those required of a good case officer. But when applied to the DDI, that system encourages the best analysts to assume supervisory positions, reducing the time available to utilize their analytical skills.

Although the CIA has several hundred "supergrade" positions¹³—and very few government agencies are permitted so high a number—there are virtually no "supergrade" slots which involve only, or even primarily, analytic responsibilities. The Agency maintains that DDI supervisors are indeed analysts, since they review and critique the work of junior analysts. In this view, supervisory positions amplify the analytical capabilities of senior personnel. Thus, there is not "supervision" in the usual sense by DDI supervisors; they are viewed as participants in the analytical process.¹⁴

The Office of National Estimates was the only place where a regular arrangement for high-level analysts existed, but that office was abolished in 1973. Today only the DDI's Office of Political Research (OPR) has been able to retain several supergrade staffers who do only analysis (out of a staff of about 40 to 50 analysts.) The OPR, created only in 1974, is treated by the DDI as an elite group. Much of its work is interdisciplinary in nature. The emphasis is placed on keeping OPR analysts out of the everyday routine of requests for current intelligence work which can be performed by other offices in the directorate.¹⁵

Some analysts complain that the personnel system has fostered too much bureaucratic "layering," and that there are too many people writing reports *about* reports. The effects are predictable. In the words of former DCI and Secretary of Defense James Schlesinger, "If you've

¹² Staff summary of Edward Proctor interview, 5/10/75.

¹³ John Clarke testimony, 2/4/76, p. 37.

¹⁴ Proctor (Staff summary), 3/1/76.

¹⁵ *Ibid.*

got too much specialization and pigeonholing of people, you get the kind of people in the intelligence game who don't mind being pigeon-holed, and the entire U.S. intelligence establishment is too much bureaucratized."¹⁶ The Intelligence Community (IC) staff, in its post-mortems of major U.S. intelligence failures, has pointed in all cases to the shortage of talented personnel. As the former deputy head of the IC staff pointed out to the Select Committee in his testimony, "giving people more flexibility in pay scale and so forth doesn't always guarantee that they hire the right people."¹⁷

F. RECRUITMENT AND TRAINING OF ANALYSTS

The Agency tends to bring analysts in early in their professional life, emphasizing lifetime careers in intelligence work and the development of institutional commitment. There has traditionally been minimal lateral entry of established analysts and experts into the profession at middle and upper levels (more in DDS&T than in DDI).¹⁸ This might be characterized as the "craft guild" approach to intelligence, where recruits are brought in to serve their apprenticeships within the ranks of the profession.¹⁹

Specialized analytical training for intelligence analysts is quite limited. The CIA's Office of Training (OTR) has a program in methodology and research techniques and a variety of mid-career courses and senior seminars. About 25% of the DDI personnel who receive in-house training are in management and executive development courses. Various DDI offices sponsor courses on specific skills such as computers and statistics.²⁰ For the most part in the past the Agency-run courses available were oriented toward developing skills necessary for clandestine activity. According to Dr. Schlesinger:

Within the CIA, most of the training effort in the past has gone into training operators rather than training analysts.²¹

The Agency maintains there is now an increased emphasis on the development of sophisticated analytical skills and understanding.

Most of the substantive training for intelligence analysts takes place outside the Agency, both in academic institutions and in other government departments. Of the total number of DDI personnel participating in such external training in FY 1975, about one quarter were involved in training courses longer than 6 weeks in duration.

G. THE INTELLIGENCE CULTURE AND ANALYTICAL BIAS

There is a set of problems stemming from what might be called the intelligence "culture"—a particular outlook sometimes attributed to the analysts which tends to affect the overall quality of judgment reflected in their work. Although the problem of preconceptions is one of the most intractable in intelligence analysis, it clearly is one

¹⁶ James Schlesinger testimony, 2/2/76, p. 72.

¹⁷ Clarke, 2/5/76, p. 38.

¹⁸ In FY 1975, 18 analysts out of 105 hired from outside the CIA by the DDI were at GS-12 to 15.

¹⁹ Marshall (Staff summary), 2/10/78.

²⁰ Proctor (Staff summary), 3/1/76.

²¹ Schlesinger, 2/2/76, p. 27.

of the most critical, and has been a focal point of the IC staff post-mortems. As one former senior official told the Select Committee, "By and large, good intelligence production should be as free as possible from ideological biases, and the higher the degree of ideological bias, the greater will be the blind spots."²²

Among the examples of analytical/intellectual bias and preconceptions are the following: In 1962, some CIA analysts judged that the Soviets would not put missiles into Cuba because such a move would be "aberrational."²³ In 1973 most of the intelligence community was disposed to believe that the Arabs were unlikely to resort to war against Israel because to do so would be "irrational," in light of relative Arab-Israeli military capabilities.²⁴

The same mechanism operated—the inability to foresee critical events, in the face of mounting evidence to the contrary—during the Cyprus crisis in the summer of 1974. According to the IC Staff post-mortem of that episode, the CIA analysts were again prey to:

the perhaps subconscious conviction (and hope) that, ultimately, reason and rationality will prevail, that apparently irrational moves (the Arab attack, the Greek-sponsored coup) will not be made by essentially rational men.²⁵

The charge is frequently made that intelligence estimates issued by the Defense Department and the military services are not wholly objective, since those groups have particular departmental interests and programs to advocate. By contrast, the CIA is supposed to be free from such bias. But although the DDI is not in the position of having to defend budgetary items or particular weapons systems, in the view of other parts of the intelligence community, there has been a tendency for a CIA institutional bias to develop over time. The Committee notes that some observers have pointed to a CIA "line" on certain issues.^{25a}

H. THE NATURE OF THE PRODUCTION PROCESS: CONSENSUS VERSUS COMPETITION

The nature of the production process can itself undermine the quality of the product. That process is consensus-oriented, varying in degree from the formal United States Intelligence Board (USIB) coordination involved in producing a National Intelligence Estimate²⁶ to the less structured daily analyst-to-analyst coordination, which takes place at the working level. For the monographs produced on an irregular basis by the Intelligence Directorate's research offices, the bulk of the coordination effort is between these offices, although occasionally such coordination will cross directorate lines, and less frequently it will involve going outside the Agency. An analyst from the DDI may meet with his opposite numbers in State or DIA prior to

²² *Ibid.*

²³ Hulzenga, 1/26/76, p. 25.

²⁴ IC Staff post-mortem on 1973 Middle East war (January 1974), p. 14.

²⁵ IC Staff post-mortem on 1974 Cyprus crisis, p. iv.

^{25a} See Chapter V, pp. 76-77.

²⁶ Prior to the President's February 1976 reorganization of the intelligence community, the USIB approved all National Intelligence Estimates. See the chapter of this report on "The Director of Central Intelligence" (pp. 74 ff.) for a fuller discussion of the estimates coordination process.

publishing an article in their mutual field.²⁷ The coordination process however necessary and desirable, may tend to produce a "reinforcing consensus," whereby divergent views of individual analysts can become "submerged in a sea of conventional collective wisdom," and doubts or disagreements can simply disappear in the face of mutually reinforcing agreements.²⁸

Although the purpose of coordination is "to assure that the facts and judgments presented therein are as comprehensive, objective, and accurate as possible,"²⁹ it sometimes has the unfortunate side-effect of blurring both the form and content of the product. The NIEs have been criticized, on occasion, for this. The estimates undergo the most formal coordination process, one which is integral to policy consensus-building. Some consumers complain that finished intelligence frequently lacks clarity, especially clarity of judgment, and that it is often presented in waffly or "delphic" forms, without attribution of views. Opposing views are not always clearly articulated. Judgment on difficult subjects are sometimes hedged, or represent the outcome of compromise, and are couched in fuzzy, imprecise terms. Yet intelligence consumers increasingly maintain that they want a more clearly spelled out distinction between different interpretations, with judgments as to relative probabilities.

In fact, the issue of consensus versus competition in analysis represents a persistent conceptual dilemma for the intelligence community. Policymakers tend to want one "answer" to an intelligence question but at the same time they do not want anything to be hidden from them. Consumer needs can change drastically in a short period of time and the same policymakers may need different kinds of intelligence for different kinds of situations.

Some members of the intelligence and foreign policy communities today argue that the consensus approach to intelligence production has improperly come to substitute for competing centers of analysis which could deliver more and different interpretations on the critical questions on which only partial data is available. This conceptual conflict should be closely examined by the successor oversight committee.

I. THE "CURRENT EVENTS" SYNDROME

The task of producing current intelligence—analyzing day-to-day events for quick dissemination—today occupies much of the resources of the DDI. Responding to the growing demands for information on current concern by policymakers for more coverage of more topics, the DDI has of necessity resorted to a "current events" approach to much of its research. There is less interest in and fewer resources have been devoted to in-depth analysis of problems with long-range importance to policymakers. The Directorate has had to devote considerable resources in order to keep up on a day-to-day basis with events as they happen. To some extent, analysts feel they must compete for timeliness with the considerable amount of raw reporting which reaches consumers.

²⁷ "The Directorate of Intelligence," Annex A, p. 2.

²⁸ IC Staff post-mortem on the 1973 Middle-East War, p. 18.

²⁹ "The Directorate of Intelligence," Annex A, p. 1.

According to some observers, this syndrome has had an unfavorable impact on the quality of crisis warning and the recognition of longer term trends. The "current events" approach has fostered the problem of "incremental analysis," the tendency to focus myopically on the latest piece of information without systematic consideration of an accumulated body of integrated evidence. Analysts in their haste to compile the day's traffic, tend to lose sight of underlying factors and relationships.³⁰

For example, the 1966 Cunningham Report points out that the CIA's sinologists were so immersed in the large volume of daily FBIS³¹ and other source reports on Communist China in the early 1960s that they failed to consider adequately the broader question of the slowly developing Sino-Soviet dispute.³²

The Intelligence Directorate is now turning more attention to such increasingly important long-term (and inter-disciplinary) problems as world food balances, raw material supplies, population pressures and pollution of the environment. Nevertheless, the DDI itself feels that an even greater effort should be made in these areas. "Such matters have not been the focus of national security interest in the past, but they clearly will be within the next ten years and this Directorate should be building its capacity to analyze and report in these fields."³³

J. INNOVATION

The CIA is thought by many observers to be technologically one of the most innovative research centers in the country, and it allocates considerable funds to continue the search for new technology. But despite recent increases, the intelligence community still expends relatively little effort on R&D in the analytical field—in contrast to intensive effort in new and costly collection methods.

The analytic community has suffered from the secrecy that surrounds the work of the intelligence community as a whole. This insulation is recognized to have had a detrimental effect on the quality of analysis. The Agency recognizes the need for conducting a free exchange with academics, contractors, and consultants. For example, in FY 1976, 17 analysts were on leave at private institutions with an additional 14 people in various Government programs (e.g., the State Department senior seminar, or the Congressional Fellows program).³⁴

Some DDI offices have panels of consultants (outsiders) to review major papers, and outside speakers are on occasion brought in for special seminars. There have been efforts like the one made by OPR to arrange for one-year sabbaticals for visiting academics during which the visitor could produce both government and public papers. Such efforts have been only partially successful.

³⁰ See IC Staff post-mortems on Middle East war and Cyprus crisis.

³¹ The Foreign Broadcast Information Service, run by the Intelligence Directorate, monitors foreign media and open source material and publishes daily surveys by area.

³² CIA Inspector General. "Foreign Intelligence Collection Requirements," December 1966 (The Cunningham Report), pp. VII-13, 14.

³³ "The Directorate of Intelligence," p. 12.

³⁴ Proctor (Staff summary), 8/1/76.

The question of CIA relations with academics and private groups like foundations and research organizations is a controversial one.³⁵ The Committee notes the desirability of a more open attitude on both sides, one which both recognizes the legitimacy of the analytic work of the intelligence community and refrains from the secret use of academics and others for operational purposes.

K. OVERLOAD ON ANALYSTS AND CONSUMERS

Few observers would dispute the fact that as consumer demands have grown and the amount of data collected has burgeoned, the analysts' work load has become a serious problem. But ten years ago the Cunningham Report expressed the concern that:

In the long run it is not the crude question of work load which matters most, nor even the point that each item uses up customers' time and attention which cannot be given to any other item, so that each of our products must receive steadily less. What matters most is the question whether this quantity of information is degrading the quality of all our work.³⁶

And the 1971 Schlesinger Report said that it was "not at all clear that our hypotheses about foreign intentions, capabilities, and activities have improved commensurately in scope and quality as more data comes in from modern collection methods."³⁷

Yet today the intelligence establishment remains structured in such a way that collection guides production, rather than vice versa; available data and "the impetus of technology" tend to govern what is produced.³⁸ To be sure, much of the proliferation in data collected has proven invaluable to the analytic effort. Technical collection systems have provided "hard" data, e.g., on missile silos which have contributed to the generally acknowledged high quality of CIA assessments of Soviet and Chinese strategic forces.

In 1971, the Schlesinger Report said, "It has become commonplace to translate product criticism into demands for enlarged collection efforts. Seldom does anyone ask if a further reduction in uncertainty, however small, is worth its cost."³⁹ The community's heavy emphasis on collection is itself detrimental to correcting product problems, said the report, for each department or agency sees the maintenance and expansion of collection capabilities as the route to survival and strength within the community. There is a "strong presumption" that additional data collection rather than improved analysis will provide answers to particular intelligence problems.⁴⁰

Analysts naturally attempt to read all the relevant raw data reports on the subjects they are working on, for fear of missing an important piece of information. The Cunningham Report referred to this as the

³⁵ See Chapter X of this report on the CIA's relations with these groups in support of intelligence collection and covert action.

³⁶ Cunningham Report, p. VIII-18.

³⁷ Schlesinger Report, p. 10a.

³⁸ *Ibid.*, p. 10a.

³⁹ *Ibid.*, p. 11.

⁴⁰ *Ibid.*, p. 11.

"jigsaw theory" of intelligence—that one little scrap might be the missing piece.⁴¹ The present trend within the DDI is to reduce the amount of raw data coming to analysts by more effective screening processes.

In the opinion of one intelligence community official, analysts in the future are going to have to rely to a greater extent than heretofore on others' judgments. The collectors themselves may have to present their output in summary form, with some means of highlighting important information,⁴² despite the community's sensitivity to the distinction between "raw" and "finished" intelligence reporting.

On the other hand, consumers tend to treat the intelligence product as a free good. Instead of articulating priorities, they demand information about everything, and the demand exceeds the supply. And analysts, perhaps for fear of being accused of an "intelligence failure," feel that they *have* to cover every possible topic, with little regard for its relevance to U.S. foreign policy interests. The community must part with the notion that it has to beat the newspapers in reporting coups in remote areas of the world if what happens in those areas is only of marginal interest to U.S. policymakers. In this regard, there are serious efforts being made by DDI to focus analysis on major areas of importance to the United States.

The community has looked increasingly to the advent of automated information-handling systems to solve the problems of systems overload, but the impact of computerization is not yet clear. In 1966 the Cunningham Report warned that "great technological advances in storage and retrieval" of information can do more harm than good if "drastically higher standards" for what is to be stored and retrieved are not instituted.⁴³

It has often been pointed out that not only are analysts swamped with information, but the consumers also are inundated with intelligence reporting, both "finished" and "raw." The volume of paper degrades the overall effectiveness of the product, since there is simply too much to read, from too many sources. In addition to the daily DDI publications and the various DDI Offices' specialized worklies and other memoranda, a variety of other intelligence publications, regularly cross the desks of senior Government officials. As former DCI Richard Helms has told the Select Committee:

It seems to me that one of the things that's tended to happen is that almost every agency has got to have its national publication. In other words, it's got to have a publication that arrives in the White House every morning.⁴⁴

Policymakers receive DIA's Defense Intelligence Notices (DINs), produced on particular subjects as the occasion demands—sometimes several per day on a given topic. NSA sends out a daily SIGINT Summary, which is not classed as finished intelligence. And a consid-

⁴¹ Cunningham Report, p. VII-10

⁴² Staff summary of Richard Shryock interview, 2/10/76.

⁴³ Cunningham Report, p. VII-12 (footnote).

⁴⁴ Richard Helms testimony, 1/30/76, p. 20.

erable amount of raw reporting of clandestine human source intelligence is routinely distributed to consumers on the NSC staff, at the Departments of State and Defense, and in the military services.

This glut of paper raises a number of issues which the Select Committee feels deserve further attention. The proliferation of departmental publications tends to undermine the centralizing nature of the system for the production of national intelligence. It contributes to confusion rather than clarity in the decisionmaking process, since different publications often present different conclusions. Often the reasons for the differences are only clear to a sophisticated intelligence analyst. And direct reporting from the collectors usually arrives before the analytical reporting can, preempting the analysts' work in evaluating the data.

L. QUALITY CONTROL

In 1972 a "Product Review Division" (PRD) was established within the IC Staff. It has the task of regularly appraising intelligence articles and studies, "testing them for objectivity, balance, and responsiveness."⁴⁵ The Intelligence Directorate has no formal or independent system for quality control, depending instead upon its regular review and coordination process.⁴⁶

Most of PRD's attention to date has been directed to the conduct of communitywide post-mortems on particular crises—for example, the 1973 Middle East war, the Cyprus crisis in 1974, the Indian nuclear detonation, and the Mayaguez incident. The Division was involved in changing the old daily *Central Intelligence Bulletin* from a CIA publication into a community publication (now called the *National Intelligence Bulletin*). PRD participated in discussions leading to the transformation of the old Watch Committee into the DCI's Special Assistant for Warning, with a Strategic Warning Staff.

PRD has not yet been significantly involved in the development of new analytical methods, in source allocation for production elements, or in training or recruitment issues. Contact with the consumers of the intelligence product has been on an irregular basis (mostly for post-mortems), although PRD is currently at work, through the NIOs, collecting consumer reactions on particular papers of concern to the USIB.

The Division has no authority to order changes in the management of production which might affect the quality of the product; rather, it has been in the position of making recommendations to the USIB and encouraging their implementation.

M. CONSUMER GUIDANCE AND EVALUATION

The DDI manages its production planning by compiling a Quarterly Production and a Quarterly Research Schedule, outlining those finished intelligence studies slated for publication in the following three months as well as projects which support other intelligence efforts, but which may not be published. The quarterly schedules are prepared by DDI's Executive Staff based on inputs received from

⁴⁵ Shryock (staff summary), 2/10/76.

⁴⁶ Proctor (staff summary), 3/1/76.

each office within the Intelligence Directorate, and the Associate DDI reviews them to ensure that the planned projects are responsive to consumer needs.⁴⁷

While there is no formal or institutionalized review by consumers of the quarterly schedules, there are frequent Directorate-level contacts with policymakers who express an interest in intelligence information and assessments on particular foreign policy issues.

Evaluation of the intelligence product by the consumers themselves is virtually nonexistent. The NSC Intelligence Committee, which was supposed to perform that function, was largely inactive and has now been abolished in the President's reorganization plan. Rarely, if ever, do high officials take the time to review the product carefully with the analysts and explain to them how the product could be improved and made more useful to policymakers. The intelligence community, then, by default, evaluates its own performance without the benefit of any real feedback. One former senior analyst told the Select Committee:

I believe there ought to be requirements on the policy side to respond by comment or otherwise to major intelligence products, obviously not the whole flow of stuff, and I think that there ought to be a responsibility at an appropriate level, say at an Assistant Secretary level, to do this, and at the NSC level. This kind of recognition, the sense of participation in a serious process is, I think, the best thing that can be done for analysts.⁴⁸

N. THE CONGRESSIONAL ROLE

Congress does not at present receive National Intelligence Estimates, although some of the estimative material is presented to the Congress in occasional briefings by intelligence officials. In the past, the Senate Foreign Relations and Armed Services Committees received the *National Intelligence Daily*, which could be cut off at executive will, and has been on some occasions, most recently in January 1976.⁴⁹ In 1975, the DDI began publishing a daily *Intelligence Checklist* specifically tailored to what it perceived to be the intelligence needs of the Congress.

With the resurgence of an active congressional role in the foreign and national security policymaking process comes the need for members to receive high quality, reliable, and timely information on which to base congressional decisions and actions. Access to the best available intelligence product should be insisted upon by the legislative branch. Precisely what kinds of intelligence the Congress requires to better perform its constitutional responsibilities remains to be worked out between the two branches of government, but the Select Committee believes that the *need* for information and the *right* to it is clear.

⁴⁷ "The Directorate of Intelligence," p. 8.

⁴⁸ Hulzenga, 1/26/76, p. 28.

⁴⁹ Laurence Stern, "CIA Stops Sending Daily Report to Hill," *Washington Post*, 2/4/76.



XIII. THE CIA'S INTERNAL CONTROLS: THE INSPECTOR GENERAL AND THE OFFICE OF GENERAL COUNSEL

Both the General Counsel and the Inspector General have played, and will continue to play, vital roles in the internal management of the Central Intelligence Agency. Both report directly to, and provide guidance to, the Director of the Central Intelligence Agency. As the principal legal officer of the Agency, the General Counsel provides legal advice to the Director of Central Intelligence; he also provides counsel and guidance to employees at all levels within the Agency on legal issues connected with the conduct of the CIA's mission. The Inspector General serves as the investigative arm of the Director and, when necessary, of the General Counsel, as well as assisting the Director and Deputy Directors in improving the performance of CIA offices and personnel.

Under the mandate of Senate Resolution 21, the Senate Select Committee studied both offices with particular attention given to the role of each in assuring that CIA activities are consistent with the Constitution and laws of the United States.¹ A number of current and former officials of the Central Intelligence Agency were interviewed or deposed. A far greater number were asked to, and did, respond in writing to a detailed questionnaire on the work of these offices.² On the basis of this investigation, the Committee is convinced of the importance of these offices and the need to maintain and strengthen them.

¹ Several provisions in the Resolution seem particularly applicable to a review of the Offices of the General Counsel and the Inspector General. Among them are: 1) Section Four which mandates examination of the extent to which Federal law enforcement or intelligence agencies coordinate their activities and the extent to which a lack of coordination has contributed to illegal, improper, or inefficient actions; 2) Section Five which mandates examination of the extent to which the operation of any activities in the United States by the Central Intelligence Agency conforms to the legislative charter of that agency and to the intent of Congress; 3) Section Six which mandates an examination of the relationship between the Director of Central Intelligence's responsibility to protect "intelligence sources and methods" and the prohibition on the Agency's exercise of police, subpoena, law enforcement powers, or internal security functions; 4) Section Eight which mandates an examination of the nature and extent to which Federal agencies cooperate in exchanging intelligence information and the adequacy of any regulations or statutes which govern such cooperation; 5) Section Nine which mandates an examination of the extent to which the intelligence agencies are governed by executive orders, rules or regulations, and the extent to which these regulations contradict the intent of Congress; 6) Section Ten which mandates an examination of the violation or suspected violation of state or Federal statutes; 7) Section Eleven which mandates an examination of the need for improved, strengthened or consolidated oversight of the United States intelligence activities by the Congress; and 8) Section Twelve which mandates an examination of whether any of the existing laws of the United States are inadequate either in their provisions or in enforcement to safeguard the rights of American citizens.

² Some 24 questionnaires were sent out. There were 15 responses ranging from 3 pages to 14 pages.

A. THE GENERAL COUNSEL

The General Counsel's work and responsibilities have changed over time, reflecting changes in CIA activities and the needs and desires of different Directors. The General Counsel's Office had originally, a staff of ten to twelve attorneys which was concerned with enactment of the Agency charter and enabling legislation, and with creation of regulations and administrative and financial procedures under which the Agency would operate. In the 1950s and 1960s, the Office was largely directed toward assisting clandestine activities overseas. Currently the Office of the General Counsel, with a staff of roughly 30 attorneys, is primarily concerned with "proposals for legislation, executive orders and other directives governing Agency activities; legal input into planning and approval of operations, stricter management and financial controls; litigation, Freedom of Information Act and Privacy Act matters; and response to requirements of Select and standing committees of the Congress."^{2a}

1. The Organization of the Office of General Counsel

Between January 19, 1951, and April 1, 1962, the General Counsel was technically a part of the Directorate of Administration, but in fact the General Counsel reported directly to the Director of Central Intelligence on most matters. In 1962 the Office was moved to the Office of the Director.³

The organization of the Office of General Counsel remained basically unchanged from the inception of the Agency until October 1975. The Office was then reorganized internally into four specialized divisions in order to permit more effective handling of the legal problems of the Agency. The four divisions are: General Law division, Operations and Management Law division, Freedom of Information and Privacy Law division, and Procurement and Contracts Law division.

Two attorneys are presently assigned as Special Assistants to the General Counsel. One of these has been assigned to the Deputy Director for Operations to provide more timely and effective counsel in the earliest stages of sensitive operational matters. The other has been assigned to the Office of Logistics, which requires continuous legal assistance in its responsibility for managing most CIA contracts. The Agency is considering assigning attorneys to the other directorates and independent offices.

Until this year most of the lawyers in the Office of General Counsel had been recruited from within the Agency. Although some of these attorneys had had legal experience outside the CIA, the Rockefeller Commission recommended, and the CIA has spent considerable effort in recruiting lawyers from outside the Agency.⁴

Lawrence Houston, the General Counsel of the Central Intelli-

^{2a}"The Role and Functions of the General Counsel," CIA paper prepared for the Senate Select Committee, 12/75, p. 2.

³*Ibid.*, 12/75, p. 2. With the exception of one year in the 1950s, the General Counsel was also responsible for supervision of the CIA's liaison with Congress. In 1960, a separate Office of Legislative Counsel was created. The Legislative Counsel is responsible for the CIA's liaison with Congress, and reports to the Director of Central Intelligence.

⁴According to the CIA, as of April 1976, over half of the attorneys employed in the Office of General Counsel will have come from outside the CIA.

gence Agency from 1947 until 1974, agreed with the Rockefeller Commission recommendation, noting that legal experience, particularly in private practice, would help Agency attorneys exercise independent judgment.

Mr. Houston also recommended that attorneys be rotated from the Office of General Counsel to other government agencies.⁶ Such rotation would lessen the possibility that these attorneys would become part of a culture which assumes that, for reasons of national security, the CIA is not governed by the normal processes of the law.

Just prior to his leaving the CIA, then Director Colby elevated the Inspector General to an executive rank equal to that of the Deputy Directors of the CIA. He agreed that the General Counsel should be similarly promoted but no action was taken, leaving the General Counsel below the Deputy Directors and the Inspector General in rank.

2. The Functions of the Office of General Counsel

The General Counsel has a wide range of responsibilities. As noted above, his primary responsibility is to advise the Director of the Central Intelligence Agency, although he also provides legal advice and guidance to employees at all levels. Under CIA regulations, he is also responsible for reviewing all new projects and activities unless they are clearly established as legal; insuring the legality of the expenditure of confidential funds;⁷ reported possible violations of the U.S. criminal code by CIA employees to the Department of Justice; passing upon all regulatory issuances; coordinating legal issues involved in CIA relations with non-Agency individuals and institutions; determining legal standards for all requests made to the CIA by, or made by the CIA to, other government agencies; and establishing proprietaries and cover mechanisms for operations. Under Executive Order 11905 he is also required to report to the Intelligence Oversight Board any activities which raise questions of legality or propriety.

3. The General Counsel's Role in Determining the Legality or Propriety of CIA Activities

As the Director's chief legal adviser, the General Counsel is responsible for determining the legality or propriety of CIA activities. CIA regulations recognize this and provide that "to ensure that CIA activities are in compliance with the law, Deputy Directors and Heads of

⁶ The CIA has endorsed the idea but has told the Committee that organizationally it would be difficult to implement. (Letter from William Colby to the Select Committee, 1/27/76, p. 7.)

⁷ Section 8(b) of the CIA Act of 1949, as amended, 50 U.S.C. 403j(b) provides: "The sums made available to the Agency may be expended without regard to the provisions of law and regulations relating to the expenditure of Government funds: and for objects of a confidential, extraordinary, or emergency nature, such expenditures to be accounted for solely on the certificate of the Director and every such certificate shall be deemed a sufficient voucher for the amount therein certified." Normally the General Counsel of the General Accounting Office would rule on the legality of the expenditure of government funds, but given 50 U.S.C. 403j(b) and the decision by the General Accounting Office to cease even the partial audits of CIA expenditures which he had conducted up until the early 1960s, the CIA's General Counsel has the responsibility for determining the legality of unvouchered expenditures. "The Role and Functions of the General Counsel," 12/76, pp. 8-4.

Independent Offices shall consult with the Office of General Counsel on all activities whose legality is not clearly established."⁸

While responsible for making determinations about the legality or propriety of CIA activities, the General Counsel also has an obligation to assist in the accomplishment of the Agency's missions. As the Rockefeller Commission Report put it, "he is subject to pressures to find legal techniques to facilitate proposed activities."⁹ This dual responsibility with its potential for conflict is not in itself unique—almost any "inside" counsel is in a similar position—but the secret and often sensitive nature of CIA activities does make protection of the independence of his judgment particularly important.

As can be seen from the regulation, the role of the Office of the General Counsel is essentially passive.¹⁰ He does not initiate inquiries, but rather consults upon request.

In the past, the General Counsel has not been asked for his opinion on certain sensitive Agency programs. During the 20-year course of the CIA's mail opening program, the General Counsel was never asked for an opinion on its legality or propriety. When the Director of Central Intelligence had doubts about whether Operation CHAOS violated the Agency charter, he did not turn to the General Counsel. As former DCI Helms stated, "Sometimes we did [consult the General Counsel]; sometimes we did not. I think the record on that is rather spotty, quite frankly."¹¹

When the General Counsel was asked for an opinion about CIA activities which were "questionable" his advice was heeded. For example, when the CIA participated in an NSA program to monitor telephone calls to and from Latin America, the General Counsel was asked for an opinion. The opinion he issued described the telephone intercept program as illegal, with the result that the program was immediately terminated.^{12a}

The principle reason for the lack of consultation was that a review by the General Counsel was not required for the initiation of Agency activities. As James Angleton has testified, "... [I]t is my impression that one of our weaknesses is that we did not have the General Counsel work into the planning phases of operations. Usually we went to the General Counsel when something was going wrong, but not in the inception of operations."¹²

⁸ CIA Headquarters Regulation, "Restrictions on CIA Activities Within the United States or Related to U.S. Citizens and Organizations," 11/28/75, 7-1a(3), p. 1.

⁹ Report of the Commission on CIA Activities Within the United States, 6/6/75, p. 87.

¹⁰ As Lawrence Houston wrote, "[t]he role could be almost completely passive but as a matter of practice it is and should be active in the sense of keeping informed as far as possible and feeling free to raise possible problems at whatever level seems appropriate." (Letter from Lawrence Houston to the Senate Select Committee, 1/76, p. 1.)

The present Deputy General Counsel has noted that given the General Counsel's new responsibilities under Executive Order 11005 and changes in attitudes at the Agency the role will be anything but passive.

¹¹ Richard Helms testimony, 9/10/76, p. 60.

^{12a} See the Committee's detailed report on NSA Monitoring for a detailed discussion of this activity and its termination.

¹² James Angleton testimony, 9/17/76, p. 48.

The CIA has explained that:

Because of the infinite variety of matters arising which would be susceptible to or might benefit from legal advice, there has been no established mechanism requiring or permitting the General Counsel to advise or rule in all cases. Some of his responsibilities are set forth in regulations or other procedures or are well known, whereas others depend on the initiative of the individual office seeking advice. Each Director of Central Intelligence has had his own preferences in methods of operating the Agency and seeking advice from the various components of the Agency. *Because of the extremely sensitive nature of some activities, there have been times when Directors have chosen to carry them out directly rather than through the normally responsible components of the Agency, in order to involve as few people as possible. In some cases a Director may not think to seek legal advice or may choose not to do so. In choosing to operate in this manner, the Director is carrying out to a degree he deems necessary his charter responsibility to protect intelligence sources and methods from unauthorized disclosure. On the other hand, he must then make his own determination as to whether this responsibility justifies some aspect of the operation which might otherwise be questionable under law.* [Emphasis added.]¹³

Under this view, the Director can still withhold from his counsel the very existence of a particular activity. The DCI could be in the position of deciding, without advice from his counsel, whether the DCI's legal responsibility to "protect intelligence sources" justified activities which would be "questionable under law."

Even under the present regulation requiring consultation with the General Counsel "on all activities whose legality is not clearly established" it is possible that the General Counsel would not be asked for an opinion about the legality or propriety of a major CIA activity. The Director could waive the regulation and instruct the appropriate official not to consult with the General Counsel. In addition, the standards in the regulation itself may cause certain difficulties.

The regulation leaves the determination of whether an activity has been clearly established as legal to the deputy directors and the heads of independent offices. Thus, these officers must interpret past decisions by the General Counsel and decide their applicability to new activities. They must interpret the regulation itself and in particular the phrase which reads "whose legality is not clearly established" in order to determine whether consultation is required. Because the regulations are prospective, activities which were legal in the past, but which have become illegal due to changes in the law, might not be the subject of consultation.

¹³ "The Role and Functions of the General Counsel, 12/75, p. 6.

It would certainly be possible to require consultation with the General Counsel on all "significant" activities.¹⁴ The General Counsel would be given a description of the activity. The referring office's reasons for believing the activity is legal might be included to enable the General Counsel to avoid a *de novo* review.

Certain acts undertaken by the CIA which may not appear significant because they do not require the expenditure of a great deal of money or the efforts of large numbers of personnel are nonetheless "significant" due to their potential for abuse. Consultation with the General Counsel should be required before the initiation of any such act.

For instance, under present regulations, the Director may approve investigation of allegations of unauthorized disclosure of classified information by individuals presently or formerly affiliated with the CIA, if he determines that intelligence sources and methods may be jeopardized by the disclosure.¹⁵

There have been a number of such investigations in the past which resulted in the extensive surveillance of newsmen, as well as a "breaking and entering" by CIA with the assistance of local police officials. Thus even though the CIA recognized that such investigations required special procedures there is no requirement that the chief legal officer of the Agency be consulted.¹⁶

The CIA has taken the position that the General Counsel's approval is not required for each such act. The General Counsel's approval of the regulations governing such acts is considered sufficient. This underestimates the difficulties deputy directors or heads of independent offices might have in interpreting regulations, and creates the possibility that actions not consonant with regulations could be approved and undertaken.

Requests for assistance made by the CIA to other governmental agencies and requests to the CIA from other agencies raise similar

¹⁴ While the Deputy Directors and heads of independent offices would have to interpret the meaning of "significant," they are in a better position to do this than to make judgments about the applicability of past opinions of the General Counsel. Some threshold is required in order that the General Counsel's Office not be swamped by a requirement to review every action by every employee.

¹⁵ The investigation must be coordinated with the FBI, when substantial evidence suggests espionage or other violation of a federal statute. CIA 7-1c(2) (b) (1).

¹⁶ As the CIA's former General Counsel has noted, the Office of General Counsel "should be consulted in connection with investigations of disclosure of classified information, or for any surveillance within the U.S." (Houston letter, 1/76, p. 1.)

Present regulations provide that the Office of General Counsel must be consulted when equipment for monitoring conversations is being tested in the United States. (CIA Headquarters Regulation, 11/28/75, H R. 7-1d5.) As that testing raises many of the same issues as does an investigation of unauthorized disclosure of classified information, there seems to be no reason for excluding the Office of General Counsel from the approval process for an investigation.

issues.¹⁷ While the General Counsel must concur with the Deputy Director for Operations on the provision of technical equipment to the Drug Enforcement Administration (DEA) for overseas operations,¹⁸ and must approve CIA requests for federal income tax information,¹⁹ he is not involved in the approval process for seeking assistance from state and local police organizations.²⁰ It should be remembered that such assistance has been provided in circumstances which were highly questionable.²¹ The General Counsel is not involved in the approval process for providing technical guidance, training, equipment, and other assistance to the Department of Defense for intelligence activities within the United States.²² Such equipment might be used by the Defense Department for illegal surveillance of citizens. In each of these situations, the Central Intelligence Agency has established special procedures for approval and monitoring; where such procedures were imposed because of the sensitivity of the operations, the procedures should specifically include consultation with the General Counsel.

4. The General Counsel's Role with Regard to Reports of Activities that Raise Questions of Legality or Propriety

a. The General Counsel's Responsibilities.—Present regulations provide that “. . . any activities or proposed activities that may raise questions of compliance with the law or CIA regulations or that otherwise appear improper will be brought directly to the attention of the Director by any of the command or staff components or by the IG and will be subject to the Director's decision.”²³ In the past, questionable activities which came to the attention of the Director or the Inspector General were not always referred to the General Counsel. For example, during a survey of the Technical Services

¹⁷ Under present regulations, the Inspector General is required to obtain a written opinion from the General Counsel on requests for “continuation or initiation of activities in support of or in cooperation with state, local, or other federal agencies whose legality and propriety have not been previously established.” (CIA Headquarters Regulation, 11/28/75, 7-1b(1).) This language has the same shortcomings noted above: the deputy director or the head of the independent office must interpret the regulation and previous decisions of the Office of General Counsel; the regulation ignores the possibility of a change in legal standards.

Written opinions of the General Counsel are generally not required by regulation or statute. The absence of a written opinion does not mean that the General Counsel did not provide advice. In many situations oral opinions have been offered. Given proper security restrictions, however, an increase in the number of situations in which written opinions are required might be desirable, as it might tend to increase the level of scrutiny by the Office of General Counsel.

¹⁸ CIA Headquarters Regulation, 11/28/75, 7-1b(5) (c).

¹⁹ CIA Headquarter Regulation, 11/28/75, 7-1c(9).

²⁰ CIA Headquarters Regulation, 11/28/75, 7-1b(3) (b).

²¹ In one instance, local police assisted the CIA in a “breaking and entering.”

²² CIA Headquarters Regulation, 11/28/75, 7-1b(4).

²³ CIA Headquarters Regulation, 11/28/75, 7-1a(4).

Similar regulations require that any employee “who has knowledge of past, current or proposed CIA activities that might be construed to be illegal, improper, or outside CIA's legislative charter, or who believes that he or she has received instructions that in any way appear illegal, improper, or outside CIA's legislative charter, is instructed to inform the Director or Inspector General immediately.” (CIA Headquarters Regulation, 11/28/75, 7-1a(6).)

Division in 1957, the Inspector General discovered activities which he labeled "unethical and illicit," but he did not notify the General Counsel. Nor was the General Counsel informed about the surreptitious administration of LSD to unwitting human subjects, discovered by the Inspector General in 1963.²⁴

Under the recently issued Executive Order²⁵, the General Counsel is personally responsible for reporting to the Intelligence Oversight Board any activities that raise questions of legality or propriety.²⁶ However, CIA regulations do not explicitly require the Director or the Inspector General to notify the General Counsel of questionable activities reported to them. The Director may waive the regulation and may instruct the Inspector General not to inform the General Counsel.²⁷ While the Inspector General is required by regulation to refer to the General Counsel "all matters involving legal questions that come to the attention of the Inspector General"²⁸ an additional, more specific, regulation only requires that the Inspector General refer to the General Counsel "information, allegations, or complaints of violations of the criminal provisions of the United States Code by CIA officers and employees, or relating to CIA affairs...."

b. Investigations by the Office of the General Counsel.--If the General Counsel does learn of questionable activities, he must rely on the Office of the Inspector General to investigate. Unlike the Inspector General who, as the DCI's investigative arm, is authorized to review all CIA activities, the General Counsel does not have general investigatory authority.

The Office of General Counsel can initiate an investigation, with the specific authorization of the Director. This requirement might prevent the General Counsel investigation of an activity about which the Director sought to restrict knowledge.

If the Director refused to authorize an investigation by the General Counsel, the General Counsel could resign and notify the "appropriate authorities."²⁹ Alternately the Director could be required to provide an immediate explanation in writing to the appropriate commit-

²⁴ A former IG explained that his reason for withholding from the Agency's General Counsel information on CIA's mail opening, which he believed to be "illegal," was that the General Counsel has already been excluded by other senior officials.

"An operation of this sort in the CIA is run--if it is closely held, it is run by those people immediately concerned, and to the extent that it is really possible, according to the practices that we had in the fifties and sixties, those persons not immediately concerned were supposed to be ignorant of it." (Gordon Stewart deposition, 9/30/75, p. 29.)

²⁵ Executive Order 11905.

²⁶ The Inspector General has an identical responsibility to that of the General Counsel under the terms of the Executive Order.

²⁷ The Inspector General would still have to report the questionable activity to the Intelligence Oversight Board. If the Director instructs him not to, he must inform the IOB of that instruction.

²⁸ CIA Headquarters Regulation, "Office of the Inspector General," 1-3a.

²⁹ These could include the IOB or its successor and the appropriate congressional committees.

tees of the Congress and the Executive branch of the reasons for denial of investigatory authority.³⁰

The General Counsel could be provided by regulation with general investigatory authority within the CIA, but this would have certain drawbacks. It could strain the General Counsel's relationship with the DCI. Lawrence Houston argued that "to give OGC investigative authority similar to that of the IG would . . . pervert its counseling role and thereby inhibit or destroy its prime usefulness."³¹ Houston noted that even if the General Counsel has the support of the DCI he will not be aware of everything going on at the Agency. "Investigative authority would not give him much more and would . . . inhibit his relations with his clients."³²

Provision of general investigatory authority to the Office of General Counsel might also involve duplication of work now done by the Inspector General. Duplication of effort in detecting and preventing abuses might be helpful rather than harmful. In all likelihood, however, in the usual course of events the General Counsel would ask the Inspector General to investigate rather than relying on his own resources.

c. The General Counsel's Access to Information.—Even if the General Counsel is consulted about all significant activities and if he is notified of all reports of questionable activities, it remains to ensure that the General Counsel will have access to necessary information.

The former General Counsel does not recall ever being denied information. The record, however, is clear that a good deal of information bearing directly on the legality or propriety of Agency operations was never given him.

According to the Central Intelligence Agency, "If an Office should 'question' the request of the General Counsel for access to any particular information, any limitations would be imposed by the Director." Thus, even today, the Director remains able to deny information to the General Counsel bearing on the legality or propriety of CIA activities. Executive Order 11905, however, requires that the Director ensure that the General Counsel has "access to any information necessary" to perform his duties under the Order.

Lawrence Houston has suggested that the General Counsel could resign if denied access to information. The Director might be required to provide an immediate explanation, to the appropriate bodies of the reasons for such a denial.³³

d. Reporting Possible Violations of the U.S. Criminal Code to the Attorney General.—Finally, it should be noted that in the past the General Counsel did not always report possible violations of the U.S. Criminal Code to the Department of Justice. Under the terms of a 1954 agreement with the Department of Justice, the Central Intelli-

³⁰ A report to the Intelligence Oversight Board may already be required. Executive Order 11905 requires the General Counsel to report to the IOB any occasion on which he was directed by the DCI not to report any activity to the IOB.

³¹ Houston letter, 1/76, p. 1.

³² *Ibid.*, p. 1.

³³ *Ibid.*, p. 2. The General Counsel might be required under the terms of Executive Order 11905 to report the refusal of access to the IOB.

gency Agency was essentially delegated the Department of Justice's power to determine whether criminal prosecution should be initiated against individuals who violated federal law. This delegation was and is unacceptable. The agreement has now been terminated.

Under present regulations, the Inspector General must inform the General Counsel of "information, allegations, or complaints of violations of the criminal provisions of the United States Code by CIA officers and employees, or relating to CIA affairs . . ." ³⁴ The Inspector General must also report to the General Counsel results of the Inspector General's investigation which is aimed at developing "sufficient facts to determine if a crime has been committed, and whether prosecution may compromise international relations, national security, or foreign intelligence sources and methods." ³⁵ The General Counsel will refer those cases where sufficient information has been developed to determine that a crime has been committed, as well as the Inspector General's report on the effect of prosecution, to the Department of Justice. ³⁶

Under Executive Order 11905, the General Counsel is not required to report to the Attorney General, but rather must report to the Intelligence Oversight Board. ³⁷

Because of the suspicions aroused by the disclosure of the CIA-Department of Justice agreement and the need to renew public confidence, it may be necessary to require that the appropriate congressional committees be given notice of CIA referrals of possible criminal violations to the Department of Justice. If this were to be done, great care would have to be taken to avoid any possibility of prejudicing the investigation or prosecution.

5. Oversight of the Office of General Counsel

Because the General Counsel's principal duty is to provide legal advice and guidance to the Director of Central Intelligence, the Director must be primarily responsible for evaluating his work. Unlike other CIA offices, however, the Office of the General Counsel has never been the subject of inspection by the Office of the Inspector General.

The General Counsel's work has not gone totally unreviewed. In 1951 a New York law firm conducted a brief review of the Office of General Counsel. Within the last year the Department of Justice conducted a management survey of the Office at the request of the Director. Given the importance of the General Counsel's Office, the absence of regular formal reviews is to be regretted.

6. Executive Branch Oversight of the Office of General Counsel

At present the General Counsel is required to "transmit to the Oversight Board reports of any activities that come to [his] attention that raise questions of legality or propriety." ³⁸ He is also re-

³⁴ CIA Headquarters Regulation, 11/28/75, 7-1a(7), p. 1.

³⁵ CIA Headquarters Regulation, 11/28/75, 1-3a(2)(e).

³⁶ *Ibid.* The regulations further provide that "reporting of the fact of a crime will not be delayed for an evaluation of whether the prosecution will raise questions of national security."

³⁷ The General Counsel may already be required to report to the Attorney General under provisions of the U.S. Code.

³⁸ Executive Order 11905.

quired to report to the Department of Justice all incidents involving possible violations of the U.S. Criminal Code as well as the results of investigations by the Inspector General. There are no requirements, however, that he provide General Counsel opinions or regular reports on the work of the Office to anyone outside the CIA.

According to the Central Intelligence Agency, regular provision of General Counsel opinions outside the Agency might raise serious problems. "To place such requirement would be violative of command relationships and lawyer-client privilege . . . [T]he Director, at his option, could make such reports available as he deemed necessary."³⁹ It has also been argued that because many of the opinions are on technical matters, regularly supplying them to those outside the CIA would not be useful.

Walter Pforzheimer, formerly the Legislative Counsel of the CIA, suggested that "a general report, oral or in writing, on major legal problems facing the Agency, or the need for additional statutory support"⁴⁰ could be provided to such groups as the National Security Council. The IOB or other such groups could be supplied legal opinions in especially sensitive areas, such as those dealing with activities that might infringe on the right of Americans.

7. Congressional Oversight of the Office of General Counsel

The same chain of command and lawyer-client privilege problems might arise if General Counsel's opinions were regularly provided to congressional oversight committees. Yet similar solutions which would greatly aid congressional oversight—regular, more general reports,⁴¹ and the provision of particular opinions or all opinions in specific sensitive areas—could be devised.⁴²

The Senate has another means by which to oversee the General Counsel, the confirmation process. Congress could require that the General Counsel be nominated by the President subject to confirmation by the Senate. This might increase the independence and stature⁴³ of the General Counsel; it would parallel provisions for Presidential nomination and senatorial confirmation of the General Counsels of executive branch departments and independent regulatory bodies. But eliminating appointment by the DCI might reduce the confidence which the Director has in his chief legal advisor.

B. THE OFFICE OF THE INSPECTOR GENERAL

The Inspector General reports to the Director and assists him in his attempts to assure that CIA activities are consistent with the Agency's charter regulations and the Constitution and laws of

³⁹ Letter from William Colby to the Senate Select Committee, 1/27/76, p. 7.

⁴⁰ Letter from Walter Pforzheimer to the Senate Select Committee, 1/26/76, p. 9.

⁴¹ In order not to short-circuit the chain of command, such reports could be made to Congress by the DCI.

⁴² The properly charged congressional oversight committees must have access to the decisions of the General Counsel, but it may be that not all the General Counsel's opinions need be sent to them.

⁴³ At present the General Counsel ranks below the Inspector General and the Agency's Deputy Directors.

the United States. In addition, the Office of the Inspector General has a wide range of responsibilities designed to improve the performance of CIA offices and personnel. The Inspector General now holds rank equal to that of the Deputy Directors of the CIA.

1. Organizational History

The Office of the Inspector General had its origin in the establishment of an Executive for Inspections and Security (EIS) in the Central Intelligence Group (CIG) on July 1, 1947. EIS was charged to provide "overall inspection, audit, and security for CIG." By 1951, audit and inspection functions had been separated; an Audit Office was established under the Deputy Director for Administration.

In November 1951, a Special Assistant to the Director assumed the inspection function. He was appointed to the newly established position of Inspector General on January 1, 1952. In March 1953, the mission and functions of the Inspector General were formally defined.⁴⁴

In 1953, the DCI appointed Lyman B. Kirkpatrick as Inspector General.⁴⁵ Mr. Kirkpatrick obtained approval from the Director in April 1953 for an inspection program which included planned, periodic inspection of Agency components (component inspections). Several inspectors were added to the IG's staff to perform this function; however, the Inspection and Review Staff in the Directorate of Plans retained responsibility for reviewing DDP components. By mid-1954, the IG's staff had expanded to fifteen, and a program of component inspections was under way. In January 1955, the DCI authorized the IG to conduct independent inspections of DDP components, separate from the DDP's Inspection and Review Staff inspections. By December 1959, the Office of the Inspector General had completed the first cycle of component inspections.

On April 1, 1962, the Audit Staff was transferred from the Directorate of Support (DDS) to the Office of the Inspector General, and

⁴⁴The issuance read:

"Mission:

"The Inspector General is charged with conducting investigations throughout the Agency on behalf of the Director and with inspecting throughout the Agency the performance of missions and exercise of functions of all CIA offices and personnel.

"Functions:

"The Inspector General shall:

"a. Make recommendations with respect to the missions prescribed for the several Offices of the Agency and with respect to such procedures and methods as may assist the Offices of the Agency more fully to perform their respective functions.

"b. Make recommendations with respect to the proper assignment of missions and functions in the overall interests of the Agency.

"c. Provide a forum where Agency personnel may, on a highly confidential basis, confide suggestions or complaints which have not received satisfactory considerations through regular channels of command or through the procedures provided for in CIA Regulation No. 20-8.

"d. Perform such other functions as may be determined by the Director."

⁴⁵In December of 1961, upon Kirkpatrick's transfer, Deputy Inspector General David R. McLean was named Acting Inspector General; John Earman was appointed Inspector General in May 1962. In March 1968, John Earman retired and Gordon M. Stewart was appointed Inspector General. He, in turn, retired in January 1972, and was replaced by William V. Broe. In June 1973, on William Broe's retirement, Donald F. Chamberlain, the incumbent, was appointed Inspector General.

the Inspector General was given responsibility for coordinating and directing the activities of the Audit Staff. The Audit Staff then had about 40 positions—its present authorized strength.

In May of 1962, the positions of Chief of the Inspection Staff and Chief of the Audit Staff were established within the Office of the Inspector General. At the same time the DCI approved an increase in the Inspection Staff from 15 to 29 positions so that all Agency components could be inspected on a two to three year cycle, and all foreign field installations could be visited at least once a year. In December 1963, in response to a call for economy measures, the Inspector General reduced inspector positions from 18 to 14.

In 1964, the Inspector General became concerned that the office lacked continuity because inspector positions were always filled by rotational assignment. He obtained approval from the Executive Director to establish two Executive Career Service permanent positions in the Office.

In June 1973, the Director abolished the component inspection program⁴⁶ and reduced the Inspection Staff to five positions, including two positions to work on Equal Employment Opportunity matters. The Inspector General's role was limited to conducting special investigations and studies, investigating charges of misfeasance, malfeasance, and nonfeasance, and handling grievance cases. In November 1974, the Audit Staff's functions were expanded to include independent program audits⁴⁷ of Agency operations which included "some of the same things that the inspection staff had done previously . . ."⁴⁸

In July 1975, following the Rockefeller Commission recommendations, the component inspection program was reinstated. The EEO function positions were transferred to a new staff in the Office of the Director. As of April 1976, the staff of the Inspector General was authorized to include approximately twenty inspectors and a new series of component inspections had been initiated.

2. The Functions of the Office of the Inspector General

The responsibilities of the Office of the Inspector General are quite broad. Under CIA regulations the Inspector General is charged with:

—[d]irecting and coordinating the activities of the Inspection Staff and the Audit Staff in conducting special investiga-

⁴⁶ According to the present Deputy Inspector General, the program was ended because Mr. Schlesinger and Mr. Colby believed "that a good deal of the kind of information that we had produced in the preceding years was not recurrent, that we had had most of the serious problems in the Agency and that Mr. Colby more specifically felt that he had new management approaches that he felt would match what the inspection staff had provided in the past." (Scott Breckinridge testimony, 3/1/76, pp. 4-5.)

⁴⁷ This function, as published in Agency regulations on May 30, 1975, is described as follows:

"Conduct supplementary, independent program audits of Agency operations pursuant to the audit standards established by the Comptroller General. Such audits will cover Agency-wide subject matter selected in coordination with the Comptroller or directorate programs selected in coordination with the Deputy Director concerned. For purposes of coordinating independent program audits, substantially qualified officers will be detailed to the Audit Staff." (CIA memorandum, "Organizational History of the Office of Inspector General, 12/75, p. 3.)

⁴⁸ Breckinridge, 3/1/76, p. 5.

tions, inspections of organizational components, and audits on behalf of the Director throughout the Agency, both at headquarters and in the field, and performing such other functions as may be prescribed by the Director.

Under the same regulations, the Chief of the Inspection Staff will:

—Conduct periodic inspections of all CIA offices for compliance with CIA authority and regulations, as well as for effectiveness of their programs in implementing policy objectives; conduct unannounced inspections of any organizational component of CIA when it appears necessary.

—Survey and evaluate any problem area or subject called to his attention . . . reporting his findings and conclusions as appropriate.

—Provide a forum wherein CIA personnel may, on a highly confidential basis, confide grievances or complaints that have not received satisfactory consideration through normal channels of command. . . .

—Investigate all reports from employees or other sources of possible violations of CIA's statutory authority.

—Investigate charges and reports of fraud, misuse of funds, conflicts of interest, and other matters involving misfeasance, malfeasance, nonfeasance, or violation of trust. In all cases involving possible violations of the U.S. criminal code, the investigation will be limited to developing sufficient facts to determine if a crime has been committed, and whether prosecution may compromise international relations, national security, or foreign intelligence sources and methods. The results of such investigations will be reported to the General Counsel for further reporting to the Department of Justice. . . .

—Refer to the General Counsel all matters involving legal questions that come to the attention of the Inspector General.

—Coordinate with the CIA Director of Equal Employment Opportunity concerning grievance cases. . . .

—Review with the General Counsel proposals for support of other government departments or agencies. . . .⁴⁹

Over the years, the principal activities of the Inspector General's Office have remained relatively constant. They have been component inspections, investigations into activities which might be construed as "illegal, improper, or outside CIA's legislative charter,"⁵⁰ and the review of employee grievances.

Component Inspections

Component inspections are studies conducted by the Inspector General's staff of offices within the Agency. They have ranged from specific surveys focusing, for example, on the Technical Services Division in the Deputy Directorate of Plans, to broader surveys such as those conducted on the Agency's major proprietaries. They include

⁴⁹ CIA Headquarters Regulation.

⁵⁰ CIA Headquarters Regulation, 11/28/75, 7-1a(6).

examinations of documents located at Headquarters, field visits overseas by members of the Inspector General's staff, and interviews of personnel within the component.⁵¹

As one former member of the Inspector General's staff noted, a component survey should include:

a review of existing policy, effectiveness and economy of operations, security, compliance with regulations and procedures, adequacy of personnel as to qualifications and numbers, morale, and any specific problem areas identified by the component itself, individuals within it, or . . . external sources.⁵²

According to the CIA, the present schedule of component inspections "will cover both field and headquarters activities . . . [T]hey should cover all Agency components every two to four years with more frequent attention given to sensitive activities."⁵³

The precise schedule for the component surveys is determined by the Inspector General in consultation with the Director.⁵⁴ According to Lawrence Houston, even the scheduling of the inspection is "salutary."⁵⁵ As one former Inspector noted:

what the component does in anticipation of the survey and during the course of the survey as problems are surfaced is often (if not usually) of more significance than are the actions taken in response to the report's recommendations. In fact,

⁵¹ In the past all, or almost all, of the personnel in the component were interviewed. According to the Deputy Inspector General, this was because "there were a lot of unresolved problems in the Agency that were hangovers from its early days of growth and development . . . and the feeling then was that a very detailed review of everything was required." (Breckenridge, 3/1/76, p. 6.) Although several former Inspectors remarked on the usefulness of this technique, particularly as it improved the morale of lower ranking employees (see e.g., Letter from John O. Lawrence to the Senate Select Committee, 2/18/76, p. 1) it has now been halted because of the "tremendous amount of repetitiveness," and because the interviews were no longer finding things that were "startling," but rather "the sort of problems that would probably turn up" anyway. (Breckenridge, 3/1/76, p. 6.)

During future component inspections, there will be selective interviews focusing on "management and policy issues"; larger numbers of personnel will be sampled in overseas stations because the Inspectors will be "looking not only for "management and policy questions", but also "for operational conduct." (*Ibid.*, p. 7.)

In the past the Inspector General also interviewed randomly selected returning field personnel. According to one former Inspector, this "was useful in alerting the Inspector General to routine problems." (Lawrence letter, 2/18/76, p. 2.)

1. Deputy Inspector General told the Committee that the Agency had dropped this program but was now reinstating it. He noted that it had provided useful information but the information had to be used as "leads," as one person usually did not have the whole story. (Breckenridge, 3/1/76, p. 47.)

⁵² Letter from Christian Freer to the Senate Select Committee, 1/22/76, p. 2.

⁵³ If this schedule were maintained, it would compare favorably to the pre-1973 schedule under which the CIA attempted, unsuccessfully, to review each component every three to five years.

⁵⁴ One former Inspector has suggested that the schedule be fixed by the Inspector General, an Executive Branch oversight committee such as PFIAB, and the congressional oversight committees, after consultation with the Director of the CIA. (Letter from Thomas Holmes to the Select Committee, 1/19/76, p. 8.) Another former Inspector noted that the tendency was to follow a fixed schedule "slavishly," instead of keeping "generally informed" of developments in all components on a continuing basis." (Lawrence letter, 2/18/76, p. 1.)

⁵⁵ Letter from Lawrence Houston to the Senate Select Committee, 1/76, p. 1.

if the inspectors do their work properly, and if the component is cooperative, there should be little to put into the report of survey.⁵⁶

On the whole it appears that past component surveys increased the effectiveness of the Agency. A former Inspector described their results as follows:

Close scrutiny of any element of the Agency by the Office of the Inspector General, preceded by anticipatory review and self-examination within that element, stimulated useful reconsideration of goals, objectives, and procedures. By providing occasions for all employees in the component to talk freely and in confidence with one or more inspectors, and thus to voice securely any comments, criticism or complaints they might have, these surveys constituted a valuable morale factor, while accomplishing the primary task of bringing to the Director's attention the overall performance and possible deficiencies of a given component as well as chronic or developing problem areas within or related to it.⁵⁷

However, the Senate Select Committee's investigation of the Office of the Inspector General found several problems. They include

a. *Access to Information.*—On certain occasions in the past, the Office of the Inspector General was denied access to material about particularly sensitive Agency activities. In the most striking example, the Inspector General was precluded from even reviewing Operation CHAOS files.⁵⁸

At present, CIA regulations provide that the Inspector General "shall have access to any information in CIA necessary to perform his assigned duties."⁵⁹ The CIA has informed the Senate Select Committee that only the Director can refuse the Inspector General access and such refusal must be in writing.⁶⁰

Thus, even under present regulations, particular Agency activities could be exempted from IG review by the Director.

If denied access to information, the Inspector General could, of

⁵⁶ Letter from Kenneth Greer to the Senate Select Committee, 1/20/76, p. 1. One former Deputy DCI, however, has suggested that the office to be inspected should not be informed. (Letter from Vice Admiral Rufus C. Taylor to the Senate Select Committee, 1/18/76, p. 1.) This would however, eliminate any "anticipatory" changes due simply to the scheduling. A former Inspector has written suggesting consultation with the Deputy Director involved as he would know of factors "relevant to the timing of the inspection, not known to the Inspector General." (Lawrence letter, 2/18/76, p. 1.)

⁵⁷ Freer letter, 1/22/76, p. 1.

⁵⁸ The substance of the program, gleaned from overseas inspections by the Office, was the subject of a paper by the Inspector General; consequently Operation CHAOS was reviewed by the Agency's Executive Director-Comptroller.

A second exclusion noted by Scott Breckinridge involved access to materials on an Agency proprietary. (Letter from Scott Breckinridge to the Senate Select Committee, 1/12/76, p. 4.)

⁵⁹ HR 1-3. Executive Order 11905 requires the Director to ensure that the Inspector General will have access to material needed to perform his duties under the Order.

⁶⁰ CIA memorandum, "Comments on the Office of Inspector General in the CIA", 1/25/76, p. 2. One former Inspector suggested that if the Director did choose to deny access to the Inspector General, it should be communicated by the DCI to the Inspector General in person. (Freer Letter, 1/22/76, p. 4.)

course, resign. The Director should be required, however, to notify the appropriate congressional and Executive branch committees of the denial immediately and to provide a written explanation for it.⁶¹

b. Problems of Emphasis.—In the past, as the Rockefeller Commission noted, “the focus of the Inspector General component reviews was on operational effectiveness. Examination of the legality or propriety of CIA activities was not normally a primary concern.”⁶²

According to the current Inspector General, more attention is now being paid to possible improper or illegal activities as well as to the legal authority for any given activity. This change in emphasis should be reinforced by the provisions of Executive Order 11905 which place personal responsibility on the Inspector General for reporting to the Intelligence Oversight Board any activities that raise questions of legality or propriety.⁶³

c. Discovering Potential Problem Areas.—As the Rockefeller Commission noted, “even with complete access, not all aspects of an office’s activities could be examined.”⁶⁴ While this is clearly true given the scale and complexity of CIA’s activities, the Committee found that certain questionable practices which should have been uncovered did not come to the Inspector General’s attention during past inspections. For instance, the CIA’s project of surreptitious administration of LSD to non-voluntary unwitting human subjects continued from the early 1950s until 1963, but escaped the notice of the Inspector General in 1957, when a broad survey of the Division responsible was conducted. The project was discovered by the Inspector General in 1963; the discovery led to its termination.

d. Referring Improper or Illegal Activities to the OGC and the DCI.—Even when improper or illegal activities were discovered in the course of a component inspection, these activities were not always referred to the Office of General Counsel.

During a survey which included a review of the CIA’s research program to develop agents which could be used to control human behavior, the Inspector General discovered activities which he labeled “unethical and illicit.”⁶⁵ Although this language was in his report, he failed to notify the Office of General Counsel and failed to call for the elimination of the questionable practices. In surveys of the CIA’s New York mail opening program, the Inspector General reported on issues of management and security, but failed to raise any question about the program’s legality with either the General Counsel or the Director, even though the Inspector General “knew” the program was “illegal.”⁶⁶

⁶¹ Under Executive Order 11905 the Inspector General is required to report to the Intelligence Oversight Board on any occasion when the Director instructs him not to report to the IOB on an activity.

⁶² Report of the Commission on CIA Activities within the United States, 6/6/75, p. 89.

⁶³ Executive Order No. 11905. Under the Order a similar responsibility is laid upon the General Counsel.

⁶⁴ Report of the Commission on CIA Activities within the United States, 6/6/75, p. 89.

⁶⁵ CIA Inspector General’s Report on the Technical Services Division, 1957.

⁶⁶ The IG under whose auspices the survey was conducted believed it was “unnecessary” to raise the matter of illegality with the Director “since everybody knew that it was [illegal]. . . and it didn’t seem . . . that I would be telling Mr. Helms anything that he didn’t know.” (Gordon Stewart deposition, 6/30/75, p. 82.)

The present Inspector General told the Select Committee that "the Inspector General does have to be certain that he leans over backward to assure that all reports which might interest the General Counsel are brought to his attention . . . it is also important that . . . legal advice is sought before a report goes to the DCI or Deputy Director, so that any legal advice becomes part of the Report."⁶⁷ Under present CIA regulations, the Inspector General must refer to the General Counsel all matters involving legal questions that come to the attention of the Inspector General.⁶⁸

e. Follow-up and Implementation of Recommendations by the Office of Inspector General.—A former Inspector noted one phase of the inspection process which he believed needed improvement. This involved:

getting a decision when the component head noncon-
 curred in a recommendation about which the Inspector
 General felt strongly. If the recommendation was of
 major importance, there was no problem, because the Di-
 rector would decide. However, on recommendations of lesser
 importance—those not worth bringing to the attention of
 the Director—there was no really effective mechanism for
 deciding which view was to prevail.⁶⁹

The present Deputy Director for Operations has suggested to the Committee that the DCI should be required to inform the Inspector General as to what action has been taken on his recommendations.⁷⁰

Problems apparently have existed not only in obtaining a decision but in obtaining one consistent with the Inspector General's recommendation. As a former Inspector General wrote:

. . . [i]t is necessary that the DCI fully back the Inspector General in his recommendations unless there are overwhelm-
 ing reasons to the contrary.⁷¹

⁶⁷ Letter from Donald Chamberlain to the Senate Select Committee, 1/13/76, p. 4. The CIA has written the Committee that "when there are legal issues involved in an IG investigation, the formal opinion of the General Counsel is sought and made part of the Inspector General's report to the Director. Comments on the Office of the Inspector General of the CIA, 1/25/76, p. 4.

It would be possible to require that all IG reports go to the Office of General Counsel. As many of these reports deal with poor management, reorganization, or grievances, this might prove more of a burden than a boon. (See *e.g.*, letters to the Senate Select Committee of Lyman Kirkpatrick, 1/13/76, p. 5 and Thomas Holmes, 1/19/76, p. 7.)

⁶⁸ CIA Headquarters Regulation 1-3. Under Executive Order 11905, the Inspector General has a personal responsibility to report to the Intelligence Oversight Board any activities that come to his attention that raise questions of legality or propriety.

⁶⁹ Greer letter, 1/20/76, p. 2. The IG's Office has now established new procedures "designed to reinforce the final effect of the inspection report." (CIA Memorandum, "CIA Inspector General: Follow-Up Procedures," 1/20/76.)

⁷⁰ Letter from William Nelson to the Senate Select Committee, 1/13/76, p. 2.

⁷¹ Kirkpatrick letter, 1/13/76, p. 2.

Yet another former Inspector General wrote:

I did not feel that the recommendations made in I.G.'s surveys commanded the attention and support at the Director's level that they merited.⁷²

A former Inspector wrote:

Too often have IG recommendations been either brushed aside or emasculated as the result of negotiations or pleadings. More unfortunate has been the growing tendency of IG reports to adjust their recommendations to the IG's estimate of what might be acceptable under the circumstances.⁷³

The IG has now been promoted to the same rank as the Deputy Directors, which may help the Inspector General obtain support for his recommendations. The present Deputy Director for Operations has suggested that if the DCI does not accept a recommendation by the IG, the IG be empowered to inform the Attorney General of the United States on matters concerning U.S. law, and the Assistant to the President for National Security Affairs on all other matters.⁷⁴

Even where the recommendations of the Inspector General are accepted, compliance has on occasion been an issue. The present Deputy Inspector General told the Committee about "two inspection reports in which the recommendations appear to have been accepted, but the compliance was below expectation. In the first case the IG subsequently headed a general investigation in the area, which had substantial results. In the second, the results of the first inspection

⁷² Letter from Gordon Stewart to the Senate Select Committee, 1/20/76, p. 1. A former Inspector described the principal defect of the Inspector General's Office as "the absence of IG clout." (Holmes letter, 1/19/76, p. 18.) Another former Inspector wrote that if a survey were "controversial (i.e. if it encountered opposition from the Deputy Director[s] affected) as a rule nothing came of the survey report's recommendations." (Lawrence letter, 2/18/76, p. 2.) The present Deputy Inspector General noted that after recommendations are drawn up, the Directorates may come back with "new information or additional considerations that will modify our understanding of the problem . . . They may persuade us in their reply that they are right . . ." (Breckinridge, 3/1/76, pp. 30-31.) He also noted that the "IG raises the issue . . . and hopes he explains it accurately and clearly, but there may be other considerations that we are not aware of that make it impractical at least at that time." (*Ibid.*, p. 31.)

⁷³ Letter from Peter Helmann to the Senate Select Committee, 3/18/76, p. 4. The Rockefeller Commission noted:

"The Inspector General frequently was aware of many of the CIA's activities discussed in this report, and brought them to the attention of the Director or other top management. The only program which was terminated as a result was one in 1969—involving experiments with behavior-modifying drugs on unknown persons." (Rockefeller Commission Report, p. 89.)

It should be recalled that the Rockefeller Commission dealt only with abuses; many IG recommendations have been accepted by the Director. Moreover, the termination of programs is not the only measure which can be taken. Programs can be changed, and controls tightened.

⁷⁴ Nelson letter, 1/13/76, p. 2. The Rockefeller Commission recommended that the IG have the authority "when he deems it appropriate, after notifying the Director of Central Intelligence, to consult with the executive oversight body on any CIA activity." (Rockefeller Commission Report, p. 94.) Under Executive Order 11906, the Inspector General has a personal responsibility to report to the Intelligence Oversight Board "any activities that come to [his] attention that raise [s] questions of legality or propriety."

were minimal and the staff which had been reviewed eventually was totally reorganized.⁷⁵

f. The Scope of the Component Inspection.—In the past component inspections have, in general, been directed at organizational units within the CIA, with much less time and attention being focused on programs or issues that cut across organizational boundaries. For example, the CIA's mail opening program was analyzed in part during the Inspector General's survey of the Office of Security, and in part during the Inspector General's survey of the Counterintelligence Staff, but it was never reviewed as a *program*. Consequently, the issues which the program raised were never fully explored and presented to the Agency's management.⁷⁶

There are other programs cutting across component lines as well as issues which affect the Agency as a whole. These deserve attention from the IG. Although surveys of these have been done in the past, the surveys have not been done on a "systematic basis as were component inspections."⁷⁷

g. Detailed Reporting Versus Issue Highlighting.—Past component inspections have been detailed and quite thorough. However, the very breadth of the surveys might have made them less useful than more selective reporting. The present Deputy Director for Intelligence, Edward Proctor, noted that :

In the past IG component surveys have been extremely detailed and involved every aspect of the component being surveyed and interviews with almost every person assigned to the component. As a result the reports resulting from these surveys contained a lot of detailed information which was of only marginal utility to the managers of the component or the Director. If IG component surveys of the future are to be focused on the important issues and activities of the more sensitive components, I would endorse them fully because they have surfaced some problems for management attention . . .⁷⁸

h. The Composition of the IG Survey Team.—The bulk of the Inspector General's staff has always been rotated to that Office from the various CIA Directorates for two or three year tours. In order to have the most qualified personnel, it was and is, necessary to ensure that the stint with the Inspector General did not damage the individ-

⁷⁵ Breckinridge letters, 3/1/76, pp. 23-25. In order to measure compliance the IG now requires the component to report on its progress in implementing agreed-upon recommendations.

⁷⁶ Domestic Report on Mail Opening.

⁷⁷ Lawrence Letter, 2/18/76, p. 2.

⁷⁸ Letter from Edward Proctor to the Senate Select Committee, 1/15/76, p. 1. One former Inspector noted that "Some surveys, especially surveys of DDO components, have tended to deteriorate into recitations of unit-by-unit organizational and administrative detail instead of providing programmatic overviews and evaluations and giving incisive descriptions of problem areas with specific recommendations." (Helmann letter, 1/18/76, p. 6.)

ual's chance for promotion.⁷⁹ It is also important that the survey team be unprejudiced. As a response to these needs, according to one former Inspector, there was:

an unwritten rule that if you came from a particular Directorate, you would not be asked to work on a team that was doing a survey of any component in that Directorate . . . [a]nd that was a hell of a good rule . . . so that if you were a youngster—or not a youngster but somewhere in the middle of your career, with a clear intention that you were going back to your parent Directorate after your two-year tour of duty or your three-year tour of duty, what the hell do you care if you come from the DDI [Directorate for Intelligence] and you call them as you see them in CI [Counterintelligence] Staff.⁸⁰

This rule was apparently not always followed. The same Inspector said that he believed that an agreement had been worked out between the Inspector General and the Chief of the Counterintelligence Staff, under which every member of the team inspecting the CI Staff had a background in the then Directorate for Plans before coming to the Inspector General's office.⁸¹ One member of that team had actually served as Deputy Chief of the Counterintelligence Staff.

Another way to preserve the impartiality of the Inspector General's staff would be to, as one former Inspector suggested, make appointments to the Inspector General's staff "career culminations" with no officer assigned to the Inspector General's staff being permitted to return to another Agency post.⁸² While the need for "career culminating" appointments and more permanent positions in the Inspector General's office were repeatedly suggested,⁸³ eliminating the rotation system would bar talented younger officers from serving in the Office.⁸⁴

Another former Inspector has suggested that in some cases the composition of the teams did not reflect the expertise needed to analyze

⁷⁹ One former Inspector has written that the IG had "insufficient authority in staff selection and promotion" and suggested that he should "have the authority to coopt, subject to approval by the Deputy Director concerned, any officer" for assignment to the IG Staff. (Lawrence letter, 2/18/76, pp. 6-7.) The present Deputy Inspector General argued against this "shopping around the building" stating that "rather than using my subjective and personal preferences, which are subject to some errors, I would prefer to have people nominated that I can reject forcing the Deputy Director to put up new people." (Breckinridge letter, 3/1/76, p. 16.)

⁸⁰ Staff summary of Joseph Seltzer interview, 1/76, pp. 14-15, *See also* letter from Thomas Holmes at 10.

⁸¹ Seltzer (staff summary), 1/76, p. 14. Present Agency policy would not allow an individual to take part in an inspection of his parent office because his "objectivity" might be affected by his being "imbued with its practices," but would allow him to be used in inspections of other offices within his parent Directorate. (Breckinridge, 3/1/76, pp. 18-19.)

⁸² Helmann letter, 1/18/76, p. 2. Since Lyman Kirkpatrick, all the Inspectors General have taken that office as their last post with the CIA.

⁸³ See e.g., Letters from Gordon Stewart 1/20/76, p. 2, and John O. Lawrence 2/18/76, p. 6.

⁸⁴ A permanent staff might also mean, as the Deputy Inspector General noted, that the IG's staff would have "less and less firsthand experience with what is current in the Agency." (Breckinridge, 3/1/76, p. 12.)

potential problem areas. As an example, he noted that inspection teams in the Deputy Directorate for Science and Technology were composed of engineers and general scientists, and thus might not be qualified to deal with certain questions, such as those involving conflict of interest, which might arise.⁸⁵

3. Investigations into Activities That Raise Questions of Legality or Propriety

The Office of Inspector General has traditionally examined allegations of questionable activities. Under the terms of Executive Order 11905, the Inspector General shall:

(1) Transmit to the Oversight Board reports of any activities that come to their attention that raise questions of legality or propriety.

(2) Report periodically, at least quarterly, to the Oversight Board on its findings concerning questionable activities, if any.

(3) Provide to the Oversight Board all information requested about activities within [the CIA].

(4) Report to the Oversight Board any occasion on which [he was] directed not to report any activity to the Oversight Board by [the Director].

(5) Formulate practices and procedures designed to discover and report to the Oversight Board activities that raise questions of legality or propriety.

At present CIA regulations provide that:

any employee who has knowledge of past, current or proposed CIA activities that might be construed to be illegal, improper, or outside CIA's legislative charter, or who believes that he or she has received instructions that in any way appear illegal, improper, or outside CIA's legislative charter, is instructed to inform the Director or Inspector General immediately.⁸⁶

Thus, all CIA employees are now on notice that they are required to provide either to the Director or to the Inspector General any information which they possess about questionable activities.⁸⁷

⁸⁵ Holmes letter, 1/19/76, p. 2. However the inspection teams are presently constituted, the Inspector General can also request assistance from the Audit Staff, which reports through him to the Director. As the auditors check components, including overseas installations, much more frequently than does the inspection staff, they can be asked to assist the inspection staff in the course of their audits. (Letter from William Broe to the Senate Select Committee, 1/17/76, p. 4.)

⁸⁶ CIA Headquarter Regulation, 1/28/75, 1-7a(b). In the past, employees were only asked to provide information about activities in which they were directly involved which might be construed to be illegal, improper, or outside the CIA's legislative charter.

⁸⁷ Under Executive Order 11905 activities which raise questions of legality or propriety must be reported to the Intelligence Oversight Board. In March 1976, George Bush, Director of the CIA, called on CIA employees to report questionable activities directly to him or to the IG.

One former Inspector suggested that the reporting of such acts would be facilitated by having a particular Inspector designated as a contact point for each major element in the Agency. (Freer letter, 1/22/76, p. 12.) The Deputy Inspector General told the Committee that at one time Inspectors were assigned to "different components, and this didn't work. They got no business. . . ." (Breckinridge 3/1/76, p. 56.)

As previously noted, the Inspector General's discovery of questionable activities has not always led to their referral to the Office of General Counsel. There can be little disagreement with the recommendation of Lawrence Houston that any question of violation of law or legal authority should be referred immediately by the Inspector General to the Office of General Counsel.⁸⁸ CIA regulations now provide that all matters involving legal questions that come to the attention of the Inspector General shall be referred to the General Counsel.⁸⁹

There is one aspect of the Inspector General's role in investigating questionable activities which may cause controversy. The present regulations provide that the Inspector General is authorized to:

Investigate charges and reports of fraud, misuse of funds, conflicts of interest, and other matters involving misfeasance, malfeasance, nonfeasance, or violation of trust. In all cases involving possible violations of the U.S. criminal code, the investigation will be limited to developing sufficient facts to determine if a crime has been committed, and whether prosecution may compromise international relations, national security, or foreign intelligence sources and methods. The results of such investigations will be reported to the General Counsel for further reporting to the Department of Justice. Reporting of the fact of a crime will not be delayed for an evaluation of whether prosecution will raise questions of national security, as outlined above. If both reports can be made at the same time without delay, they may be so reported.⁹⁰

There is an obvious need to insure that a prosecution does not jeopardize important United States interests. The IG appears to be well-suited to evaluate its effect. It should be remembered that confidence in the judicial system is important and it can be undermined if people believe that individuals are exempted from prosecution solely because of their connection with the intelligence community.

Conducting preliminary investigations to determine if a crime has been committed may however, raise difficult issues. Great care must be taken so that later and fuller investigations will not be hampered. The level of care must be such that there can be no suspicion that Agency officials have failed to impartially investigate allegations of wrong-

⁸⁸ Houston letter, 1/76, p. 2.

⁸⁹ CIA Headquarters Regulation, 1/28/75, 7-1a (7), p. 1. The Agency regulations dealing with the reporting of questionable activities only require the IG to refer such reports to the General Counsel when allegations of violations of Title 18 of the U.S. Code are received. While the regulations may reflect a desire not to have to refer disciplinary matters to the General Counsel (e.g., see Breckinridge, 3/1/76, p. 43), the importance of preventing future violations of the law by the CIA compels General Counsel participation in the process of reviewing reports of questionable activities.

⁹⁰ CIA Headquarters Regulation, 1-3. In certain instances in the past, the Office of Security has investigated individual allegations. (Breckinridge letter, 1/12/76, p. 3.)

Prior to the decision in *Miranda v. Arizona*, 384 U.S. 433 (1966) the Inspector General conducted complete investigations of alleged violations of law by Agency employees. After the decision in order to protect individual rights and to avoid compromising future prosecution the Inspector General limited his investigations to the determination of whether a crime had been committed.

doing by their colleagues.⁹¹ To prevent suspicion it might be desirable for the Inspector General to maintain a list of allegations and the results of the IG's preliminary investigations for periodic inspection by the Department of Justice and the appropriate congressional committees.

4. Investigation of Grievances

CIA regulations provide for the airing of grievances through the normal chain of command to the Director of Personnel and finally to the Director of Central Intelligence Agency through the Inspector General. In addition, the regulations direct the Inspector General to provide a forum for grievances which have not received satisfactory consideration through the normal channels and empower him to accept direct appeals when appropriate.⁹² In certain circumstances this grievance machinery may facilitate the detection of illegal or improper activities by Agency officials.⁹⁴

It is Agency policy that "relief first be sought in the chain of command,"⁹⁵ but direct recourse to the Inspector General is available "where an employee feels he cannot go through normal channels without jeopardy to his career, or other rare exceptional circumstances."⁹⁶

This direct channel for the airing of grievances should be maintained with the IG being provided the "authority to counter the possibility of reprisal against the employee."⁹⁷ The mechanism might be more heavily publicized.⁹⁸ Because of the importance of having a mechanism outside the CIA, employees should be aware that they can go to the appropriate congressional oversight committees.

"It would be possible for any "information, allegations, or complaints of violations" to be referred to the Department of Justice immediately, without a preliminary investigation by the Office of the Inspector General. This might, however, result in a substantial number of unfounded complaints being referred to the Department of Justice. As the present Deputy Director for Operations wrote the Committee:

"[t]here are in any organization individuals who are quick to allege misconduct or improper activity on the part of their superiors or peers. The question as to whether these allegations have any substance can best be initially determined by the Inspector General. Immediate referral to another body will result in harassment-type investigations, will in certain cases broaden the security damage and even eventually result in poor follow-up on real charges when enough other cases have proven to be unsubstantiated." (Nelson letter, 1/18/76, p. 1.)

⁹¹ CIA Headquarters Regulation, 20-7.

⁹² CIA Headquarters Regulation, 1-3.

⁹³ Holmes letter, 1/19/76, p. 11.

⁹⁴ Memorandum from Scott Breckinridge to Chief, Review Staff, 3/17/76, p. 2.

⁹⁵ Holmes letter, 1/19/76, p. 11.

⁹⁶ The present Deputy Director for Intelligence has recommended that the normal chain of command grievance procedures be publicized, and the Inspector General instructed to "resist the temptation to get involved prematurely in grievances." (Proctor letter, 1/15/76, p. 7.)

One former Inspector has noted that:

"[w]henver an employee challenges the Agency itself, as contrasted to a component or an Agency official, he is also challenging the Inspector General, since the latter is necessarily a representative of the Agency. Thus, the Inspector General can not be an impartial arbiter between the Agency and the employee. This was a source of frustration to employees who brought such cases to the Inspector General. Such employees should have an external administrative appeal available either in addition to or as a bypass of the Office of Inspector General." (Lawrence letter, 2/18/76, p. 7.)

C. INTERNAL AND EXTERNAL REVIEW OF THE OFFICE OF THE INSPECTOR GENERAL

The Inspector General reports to the Director of the Central Intelligence Agency, and the Director has the primary responsibility for evaluating this office. The Office has not, however, been regularly or formally reviewed. Some mechanism for internal inspection of the Office of the Inspector General should be devised.

The Inspector General was aware of questionable activities, some of which continued for many years with the approval of the Agency's top management. This underscores the importance of outside reviews of the Agency. To be effective, the reviewing bodies must have access to the Inspector General's work.

A number of individuals familiar with the work of the Office of the Inspector General have argued against the Inspector General's having a direct reporting responsibility outside of the CIA. Lawrence Houston noted that if the Inspector General reported directly to anyone other than the Director, two crucial elements would be lost: "first the absolute candor that should exist in his relations with the Director and second the ability to protect the integrity of his files and the confidentiality of his findings and recommendations."⁹⁸ The Committee has also been told that "any arrangement which would separate the Inspector General from his present relationship to Agency management would tend to result in a lack of candor and a resistance to revealing sensitive details in investigations and this would inevitably result in diluting the authority and effectiveness of the Inspector General."⁹⁹

A start in outside reporting has been made. Under Executive Order 11905 the Inspector General must report to the Intelligence Oversight Board any activities that raise questions of legality or propriety.¹⁰¹

But Executive Branch oversight of the CIA or the CIA's Inspector General is not sufficient. The Inspector General should be available to the appropriate congressional oversight committees.¹⁰² And some form of reporting on the work of the Office of the Inspector General should be made, with appropriate safeguards, to the appropriate congressional committees.

The present Inspector General believes that :

[t]he I.G. could and perhaps should provide our oversight committees with the following: (1) a summary of our findings on each component survey, one which would reveal prob-

⁹⁸ Houston letter, 1/76, p. 1.

⁹⁹ Comments on the Office of the Inspector General, 1/25/76, pp. 2-3. However, Scott Breckinridge wrote that "If so directed by the DCI, elements being inspected will continue to be as forthcoming as in the past. There is no reason to expect that this will not be the case." (Breckinridge letter, 1/12/76, p. 5.) Mr. Breckinridge noted, however, that if reports were to be made available to outside bodies, less detail might be provided "in support of conclusions and recommendations."

¹⁰¹ *Ibid.* Prior to the issuance of the Executive Order, CIA regulations, amended to conform to the recommendations of the Rockefeller Commission, required reports to be sent to the NSC and PFIAB.

¹⁰² Letter from John McCone to the Senate Select Committee, 1/30/76, p. 2. Former DCI McCone wrote that the IG should not report to anyone outside the Agency such as the PFIAB, the NSC or congressional oversight committees. The IG, should be however, "available to all of these groups." (*Ibid.*, p. 2.)

lems and recommended solutions but not give operational details; (2) a semi-annual summary of all other cases, emphasizing trends, general problems, etc., but not giving names of individuals or sensitive details which might identify individuals.¹⁰³

Such reports, coupled with access, where necessary, to the results of particular inspections or reviews by the Inspector General, would greatly aid congressional oversight of the CIA.¹⁰⁴ Congressional evaluation of the work of the Office of the Inspector General might be facilitated by requiring the Inspector General to provide the oversight committee with a plan of action setting out "priority surveys to be done and why, the schedule to be followed, the dates reports would be completed, [and] the actions taken on reports (or the non-actions) and why."¹⁰⁵

A second means for Congress to oversee the work of the Inspector General would be to make the Inspector General subject to presidential nomination and senatorial confirmation. Presidential appointment, however, might inadvertently give position of Inspector General a political coloration which would diminish the effectiveness of the Office.

¹⁰³ Chamberlain letter, 1/13/76, p. 4. In order to reinforce the chain of command such reporting could be done via DCI's reports to the oversight committees.

¹⁰⁴ One former Inspector argued against congressional access without the DCI's concurrence as leading to "congressional involvement in Agency minutiae," the erosion of security, and the reduction of the candor of Agency employees vis a vis the IG. (Helmann letter, 1/18/76, p. 2.) Another former Inspector wrote that if all IG's reports were to be sent to Congress they would "become less candid and more conservative." (Lawrence letter, 2/19/76, p. 5.) Another former Inspector suggested that "an active and strong congressional oversight committee would be my first choice" as an "outside authority" which would correct problems that the IG discovers. (Holmes letter, 1/19/76, p. 6.)

¹⁰⁵ Holmes letter, 1/19/76, p. 12. The submission of such a plan would allow the IG to be evaluated on the basis of his own plan, which would be approved by the IG and the committees. The committee "would be assured that the IG was planning to do what the committee expected them to do." *Ibid.*

The IG is required, under Executive Order 11905 to report to the Intelligence Oversight Board the "practices and procedures" formulated to discover questionable activities 'y the CIA.

XIV. THE DEPARTMENT OF STATE

In addition to strengthening our defense, the purpose of U.S. intelligence activities is more effective foreign policy. Intelligence informs foreign policy decisions and in the role of covert action seeks to attain foreign policy objectives. In sum, intelligence is a service, a support function, indeed it is so designated and structured by the military services. However, in the field of foreign policy, intelligence activities have sometimes become an end in themselves, dominating or divorced from policy considerations and insulated in important respects from effective policy oversight.

The Department of State is responsible for the formulation and execution of foreign policy. Yet unlike the Department of Defense, the State Department has no command over intelligence activities essential to its mission except the Foreign Service.

The Department of State and the American Foreign Service are the chief producers and consumers of political and economic intelligence in the United States Government. The Department participates actively in the interagency mechanisms concerned with collection and production of intelligence. However, it has been unable or unwilling to assume responsibility over clandestine intelligence activities.

The Foreign Service competes with the Clandestine Service in the production of human source intelligence, but operates openly and does not pay its sources. The State Department, as well as American ambassadors abroad, is called upon, at least in theory, to exert a measure of control over certain aspects of CIA's secret overseas activities. Indeed, the State Department through U.S. embassies and consulates offers the only external check upon CIA's overseas activities; they are the only means abroad that can help assure that America's clandestine activities are being carried out in accord with the decisions made at the highest level in Washington.

The primary purpose of the Select Committee's inquiry was to examine the effectiveness of the Department of State and the Foreign Service in this role. The Committee also examined the Foreign Service intelligence collection efforts.

To this end, the Select Committee visited several overseas missions, embassies and consulates and conducted extensive interviews with ambassadors, Foreign Service officers and State Department personnel as well as taking sworn testimony. From this investigation it is evident that the role of the Department of State is central to fundamental reform and improvement in America's intelligence operations overseas.

A. ORIGINS OF THE STATE DEPARTMENT INTELLIGENCE FUNCTION

It has been the traditional function of the Department of State and the Foreign Service to gather, report and analyze information on foreign political, military, economic and cultural developments. That

intelligence function, like most of the responsibilities of the Department, is not established by statute. The basic statement of the duties and responsibilities of the Secretary of State is contained in an Act of Congress of July 27, 1789, as follows:

The Secretary of State shall perform such duties as shall from time to time be enjoined on or intrusted to him by the President relative to correspondences, commissions, or instructions with public ministers from foreign states or princes, or to memorials or other applications from foreign public ministers or other foreigners, or to such other matter respecting foreign affairs as the President of the United States shall assign to the department and he shall conduct the business of the department in such manner as the President shall direct.¹

The statutes are no more precise about the functions of the Foreign Service, and the members which

shall under the direction of the Secretary [of State], represent abroad the interests of the United States and shall perform the duties and comply with the obligations resulting from the nature of their appointments or assignments or imposed on them by the terms of any law or by any order or regulation issued pursuant to law or by any international agreement in which the United States is a party.²

Most Presidents have chosen to use the Secretary of State as their principal advisor and agent in foreign affairs; foreign intelligence activities of the Department and Foreign Service have developed in a logical pattern from that practice.

Today the President's Executive Order assigns to State responsibility for collecting overtly "foreign political, political-military, sociological, economic, scientific, technical and associated biographic information."³ The reporting of the Foreign Service, together with that of the military attaché system, based on firsthand observation and especially on official dealings with governments, makes up the most useful element of our foreign intelligence information. Clandestine and technical sources provide supplementary information, the relative importance of which varies with the nature and accessibility of the information sought.

While clandestine and technical sources of information are today the responsibility of the CIA and other agencies, State is not without past experience in such matters. The Department operated one or more clandestine intelligence networks during and after World War II and closed them down, at CIA insistence, only in the 1950s. The Department engaged in such activities in earlier times. On the technical side, the State Department operated a cryptanalytic unit called the Black Chamber during the inter-war years. It was abolished by Secretary Stimson in 1929 on the ground that "gentlemen do not read each other's mail."

¹ R. S. § 202, 22 U. S. 2556.

² 22 U. S. 841.

³ Executive Order No. 11905, 2/18/78.

Although foreign intelligence has always been a major function of the State Department, the Department had no separate—and acknowledged—intelligence unit prior to World War II. At the end of the war, the research and analysis branch of the Office of Strategic Services (OSS), numbering over 1,500, was transferred to the Department, and the position of Special Assistant to the Secretary for Research and Intelligence was established to head the new organization into which was incorporated as well certain existing State units.

President Truman initially contemplated a much more significant intelligence role for State and directed Secretary Byrnes to

take the lead in developing a comprehensive and coordinated foreign intelligence program for all Federal agencies concerned with that type of activity. This should be done through the creation of an inter-departmental group, heading up under the State Department, which should formulate plans for my approval.”

Although Dean Acheson, as Under Secretary, moved promptly in the fall of 1945 to develop such plans, he soon

encountered heavy flak. It came from three sources: congressional opposition to professional intelligence work, civil disobedience in the State Department [i.e. the geographic divisions opposed “intelligence work not in their organizations and under their control”] and indecision in high places brought on by military opposition to both unification of the services and civilian control of intelligence.³

In the end Secretary Byrnes bowed to this opposition and joined in recommending to the President what Acheson calls “an odd plan for a National Intelligence Authority and a Central Intelligence Group, . . . thus moving primacy in intelligence from the State Department to the Executive Office of the President.”⁴

Byrnes also adopted the recommendations of the Department's geographic divisions and broke up the OSS research and analysis unit which State had inherited, dispersing its personnel to those divisions. However, this decision was reversed by General Marshall shortly after he became Secretary of State in January 1947 and State has since then had a central intelligence unit, now generally known as INR (Bureau of Intelligence and Research). INR's stature and influence in the Department have gradually increased, though its size has been greatly reduced, numbering today some 325 with a budget of less than \$10 million. The reduction has resulted in part from budgetary pressures, in part from the transfer of certain functions (e.g., contributions to the now-defunct National Intelligence Survey, biographic reporting) to the CIA.

The organization is made up of two directorates reflecting the two basic responsibilities of the organization. The Directorate for Research produces finished intelligence (reports and estimates) to meet the operating and planning requirements of the Department. The Direc-

³ Dean Acheson, *Present at the Creation* (New York: W. W. Norton and Co., 1969), p. 158.

⁴ *Ibid.*, p. 159.

⁵ *Ibid.*, pp. 160-161.

torate also participates in the production of National Intelligence Estimates. The Directorate for Coordination is concerned with the Department's relations with the other intelligence agencies on matters other than the production of substantive intelligence. This includes (a) the provision of Departmental guidance on operational intelligence questions, including staff support for State participation on the 40 Committee; (b) management of assignment of Defense Attaché personnel; and (c) development of positions on intelligence requirements and the allocation of intelligence resources.

However, INR has no personnel abroad and is not responsible for the collection of intelligence overseas. The substantive direction of the U.S. embassies and consulates, which are the intelligence collectors, is the responsibility of the geographic bureaus.

B. COMMAND AND CONTROL

In viewing the role of the Department of State in command and control of intelligence operations, it is necessary to distinguish between Washington and the embassies abroad. The authority and responsibility of the Secretary of State in this area differs markedly from that of the Ambassador. Secondly, a distinction must be made between covert operations, where the influence of the Department and the Ambassador is normally substantial, and clandestine intelligence and counterintelligence operations (espionage and counterespionage), where the role of the Department, and sometimes but not always that of the Ambassador, is minimal.

1. *Role of the State Department in Washington*

The duties and responsibilities of the Secretary of State, in general, and for the direction and supervision of U.S. foreign intelligence operations in particular, have not been defined by statute. Proposals after World War II to put the Secretary of State in overall control of U.S. foreign intelligence activities were rejected. The role of the Secretary appears to be further downgraded in the President's Executive Order of February 1976. The State Department is not represented on the new Committee on Foreign Intelligence and the Secretary is only authorized to "coordinate with" the DCI to ensure that United States intelligence activities and programs are useful for and consistent with United States foreign policy.

Nevertheless, the Secretary is the senior Cabinet member, his primary within the executive branch in foreign relations has usually been accepted, and his Department is the only one with knowledge, personnel and facilities abroad to exercise effective control over foreign operations. A Secretary who is disposed to assert his potential influence and who has the support of the President can exercise considerable control over CIA activities. This is clearly the situation today. It is equally clear that it was not the situation under the previous Secretary of State, William Rogers, who not only did not play an active role in the intelligence area but on at least one occasion, the Committee found, was systematically and deliberately kept in the dark regarding important CIA operations.⁵

⁵ Senate Select Committee, "Alleged Assassination Plots Involving Foreign Leaders," p. 281.

Apart from his relationship with the President, however, the Secretary of State has had only limited influence upon the CIA. The Secretary of State does not have access to CIA communications, except as prescribed by the DCI. This privileged position, it is contended, is sanctioned by the provision of the National Security Act of 1947 making the DCI responsible for protecting intelligence sources and methods from unauthorized disclosure. The Secretary of State knows only as much about CIA operations as CIA elects to tell him. Secondly, except for covert action operations considered by the 40 Committee, he has had no voice in the expenditure of CIA funds abroad. This is in contrast to the role the Secretary of State has with regard to expenditure of Military Assistance Program funds.

The Secretary of State's influence or control over CIA operations varies greatly, depending upon the nature of the activity. It has been greatest in the area of covert action, least in the area of espionage. In the setting of intelligence requirements and the allocation of intelligence resources, the Secretary of State has a voice but it is only one voice out of many.

Authority for State influence over covert operations derives from NSC directives and is exercised through membership on the 40 Committee (now the Operations Advisory Group--OAG), which reviews and recommends approval of such operations and certain sensitive reconnaissance programs. Until the Kennedy administration, State chaired the Committee. During the Kennedy and Johnson administrations, even without the chairmanship, State often had a virtually controlling voice, through its veto power. Covert action and sensitive reconnaissance operations are normally not presented to the Committee unless cleared in advance with (or originated by) State and, where this is not the case, a negative State position has rarely been overridden. There have, however, been important exceptions, notably during the first Nixon term when State influence declined markedly. On one occasion the 40 Committee itself was bypassed.⁶

The leading role which State has normally played in the 40 Committee stems from the fact that covert actions are designed to further foreign policy objectives. But operations clearly have driven policy in many instances. It is the CIA, not State, which is called on, in the first instance, to explain and justify these programs to Congress. In part this has been due to a desire to preserve State's "deniability." However, that has apparently ended with President Ford's Executive Order which formally requires Secretary of State attendance at OAG meetings.

In contrast to the 40 Committee mechanism for covert action operations, there is no systematic procedure for Washington review and approval of clandestine intelligence and counterintelligence (espionage and counterespionage) operations outside CIA. The distinction was made by former DCI Richard Helms in this way:

Mr. HELMS. Exactly. Now this was one kind of approval for the so-called political action projects. They had to be approved not only once a year, but as they came forward each time. And thus they had to be sent to the Approval Com-

⁶ *Ibid.*, p. 225.

mittee, you know, it has been variously known as 303 and Forty and Special Group and so forth. So there was a special mechanism to have those projects cleared in the Special Group.

The intelligence projects had a different kind of clearance mechanism, because they could be done under the Director's own authority. As you recall, NSCID Number 5 gives the Director the authority to do foreign intelligence [checks?] and counterespionage on his own recognizance, he doesn't have to check it out with anybody as to whether he did this or that or something else.

Q. Is that a good system? When you were Director you had a sensitive collection program or counterintelligence program. Did you often or sometimes check with the President or somebody in the White House or the Secretary of State about the advisability or risks? Did you regard that as really basic to your job?

Mr. HELMS. It was left to my judgment when I was Director as to whether I cleared it with anybody or not.

Q. Did you very often?

Mr. HELMS. From time to time I did. I was involved with that Berlin Tunnel, for example, and I remember, we did check that out before we went ahead with it.

Q. You did or did not?

Mr. HELMS. We did. And there were certain others that we checked out before we went ahead with them. I don't remember what they all were now. But there was a rule of reason that was permitted to prevail here. And I think most directors were sensitive enough fellows that if you were really going to run a serious risk to our diplomatic life or our foreign policy life, you might want to go to see the Secretary of State or somebody to hold hands on those things.⁷

Thus State is effectively excluded from the decision to carry out espionage operations unless CIA elects to consult. Because in practice State is rarely consulted,⁸ it does not have institutional arrangements to develop advice and guidance in this area—as it does for covert action operations.

The Committee is strongly of the view that these informal arrangements, which leave consultation to the discretion of the DCI and which do not fix any responsibility on the Secretary of State, have proved to be harmful. Two areas of concern can be cited: First, some espionage operations, e.g., the attempted recruitment as an agent or an official of a friendly government, can have major adverse foreign policy repercussions. Second, certain types of espionage operations have had the effect of covert political action. For example, a subsidy to the leader of a dissident group to facilitate the collection of information about the group, has been taken by the leader (and the government in power) as support for his dissidence. Thus a DCI cannot be subject to

⁷ Staff summary of Richard Helms interview, 9/11/75, p. 62.

⁸ Out of hundreds of agent recruitment efforts last year the Secretary of State was consulted on less than five.

40 Committee or other controls by defining an operation with significant political impact as espionage. State Department review of espionage operations is needed to provide support and advice to ambassadors in field supervision of CIA activities.

2. *Command and Control in the Field*

In contrast to the uncertain authority of the Secretary of State, the authority of the Ambassador with respect to U.S. intelligence activities in his country of assignment is clear, and, since 1974, has had a statutory basis.

In 1961, President Kennedy addressed a letter to each Ambassador stating that he expected him "to oversee and coordinate all activities of the United States Government" in his country of assignment.⁹

That letter appears to have remained in force until it was superseded, in December 1969, by a similar letter from President Nixon which included the following:

As Chief of the United States Diplomatic Mission, you have full responsibility to direct and coordinate the activities and operations of all of its elements. You will exercise this mandate not only by providing policy leadership and guidance, but also by assuring positive program direction to the end that all United States activities in (the host country) are relevant to current realities, are efficiently and economically administered, and are effectively interrelated so that they will make a maximum contribution to United States interests in that country as well as to our regional and international objectives.¹⁰

This letter was supplemented by a classified State Department instruction,¹¹ concurred in by the Director of Central Intelligence, which advised the Ambassador how the President's letter should be interpreted with regard to CIA. The effect of this instruction is to make the Ambassador's access to information on intelligence sources and methods and his authority to approve or disapprove CIA operations subject to the agreement of the Chief of Station and, in the event of disagreement, to Washington for decision. It may well also have had the effect of inhibiting ambassadors in seeking to inform themselves fully in this area.

In 1974, the authority of the Ambassador was given a statutory basis. The following new section was added to "An Act to provide certain basic authority for the Department of State," approved August 1, 1956, as amended:¹²

Authority and Responsibility of Ambassadors. Under the Direction of the President—

(1) the United States Ambassador to a foreign country shall have full responsibility for the direction, coordination,

⁹"The Ambassador and the Problem of Coordination, A Study Submitted by the Subcommittee on National Security Staffing and Operations (Pursuant to S. Res. 13, 88th Cong.) to the Committee on Government Operations, United States Senate."

¹⁰State Department Foreign Affairs Manual, 1 FAM 011.2, 1/27/70.

¹¹CA-6003, 12/17/69.

¹²22 U.S. 2680a.

and supervision of all United States Government officers and employees in that country, except for personnel under the command of a United States area military commander;

(2) the Ambassador shall keep himself fully and currently informed with respect to all activities and operations of the United States Government within that country, and shall insure that all government officers and employees in that country, except for personnel under the command of a United States area military commander, comply fully with his directives; and

(3) any department or agency having officers or employees in a country shall keep the United States Ambassador to that country fully and currently informed with respect to all activities and operations of its officers and employees in that country, and shall insure that all of its officers and employees, except for personnel under the command of a United States area military commander, comply fully with all applicable directives of the Ambassador.

The legislative history indicates that this statute was intended to give statutory force to existing directives. However, under any reasonable construction, it goes well beyond the Nixon letter, particularly as interpreted by the State Department instruction cited above. Nevertheless, more than a year after its enactment, no new regulation or directives have been issued by the executive branch in implementation of the statute, nor does it appear that it necessarily plans to take any action to modify present guidelines. In response to the Committee's inquiry, the White House has advised the Chairman as follows:

As you know, the issues addressed by this legislation were encompassed in President Kennedy's letter of May 29, 1961, President Nixon's similar letter of December 9, 1969, and the Department of State Circular Airgram 6693 of December 17, 1969. In addition, the Department of State in July 1975 sent the relevant section of Public Law 93-475¹³ to all major embassies in confirmation and reinforcement of existing guidelines. The President is considering further steps and we will keep you informed of any additional action that is taken.¹⁴

So far as the Committee knows, no Ambassador has sought to invoke the statute in seeking information on CIA operations. One senior Ambassador testified that the statute is not really in effect without implementing regulations in the executive branch:

Ambassador PORRER. Yes, but when you get the legislation but you don't get the regulation based on it, you're not much better off. That '74, yes, sir, that '74 addition to the basic State Department Authorization Act, that really isn't in force because the implementing regulations have not been issued.

Senator MONDALE. Well, Mr. Ambassador, when a law is passed, that is the law, is it not?

¹³ *Ibid.*

¹⁴ Letter from Phillip Buchen, Counsel to the President, to Senator Church, 12/22/75.

Ambassador PORTER. Yes, sir.

Senator MONDALE. Can a law be repealed by failing to issue regulations?

Ambassador PORTER. Repealed?

Senator MONDALE. Suspended.

Ambassador PORTER. Suspended? I would say yes.

Senator MONDALE. I think the word is "inoperative."¹⁵

The statute is apparently also "inoperative" so far as the CIA is concerned, as indicated by the following CIA written responses to Committee questions:

—If the Ambassador asked to see every operational report (as opposed to intelligence report) what would the Chief of Station say?

The Chief of Station would inform the Ambassador that he is referring the Ambassador's request immediately to his headquarters for guidance.

—Is there any place where agent recruitments are cleared by the Ambassador or the Secretary of State, including real names?

Individual agent recruitments are not cleared with either the Ambassadors or the Secretary of State.¹⁶

The Committee staff has learned that there are divergent views within the executive branch regarding implementation of the new statute. It is clear from the testimony that CIA opposes giving the Ambassador the unrestricted access to its communications and other operational information that the law would appear to authorize. In the past, the Agency has argued that this would conflict with the provision of the National Security Act making the Director of Central Intelligence responsible "for protecting intelligence sources and methods from unauthorized disclosure." However, the statute resolves any doubts as to whether disclosure to the Ambassador is authorized.

There are also other problems, of a practical nature, in implementing the statute. Can an Ambassador, without additional support from Washington, effectively direct and supervise the work of CIA personnel? The basic responsibility of the Ambassador is for United States relations with the country to which he is accredited. The Ambassador is expected to be highly knowledgeable about the country to which he is assigned. For CIA operations conducted within his country of assignment, the Ambassador should be a good judge of the risks of such operations, and of their possible usefulness to the U.S. It is often the case, however, that CIA espionage operations mounted from his embassy are directed against a *third* country, more often than not a denied area country.¹⁷ There is no assurance that the Ambassador is qualified to assess fully the risks or benefits of such operations. Nor, if he perceives that an operation directed from his embassy in Country X against the denied area country poses a risk to U.S. relations with Country X, is he able to weigh that risk against the potential benefits of the intelligence to be gained. Such judgments often can only be

¹⁵ William J. Porter testimony, 11/11/75, pp. 45-48.

¹⁶ William Nelson testimony, 12/10/75, Attachment B.

¹⁷ Essentially the communist countries.

made in Washington. Washington is where the problem arises. No one outside the CIA, unless it be the President himself, is responsible for directing and supervising CIA clandestine intelligence operations or is authorized access to the information necessary to do so.

A logical corollary to 22 U.S. 2680a would, thus, be to assign to a Washington authority responsibility for control and supervision of clandestine intelligence collection paralleling that assigned to the ambassadors. The responsibility might be assigned to the Secretary of State or to the 40 Committee. Either way, the Department of State would have to have access to operational and source information to which it is not privy today, if meaningful supervision and control is to be exercised.

Ambassadors interviewed by the Committee all recognize some degree of responsibility for supervision of CIA activities and cite President Nixon's letter of 1969 as the governing document. Most express misgivings about their ability to do so with confidence of support from Washington. The lack of access to CIA communications leaves a residue of doubt that the Ambassador really knows what is going on. Vigor and initiative on the part of Ambassadors seems lacking. Most Ambassadors the Committee has talked with have not appeared inclined to request detailed information, particularly regarding espionage operations.

Supervision of intelligence activities by Ambassadors is in fact uneven and, when exercised, the methods used differ widely. Much depends on the knowledge and experience of the Ambassador, and the support he has or believes he has in Washington. Further, the Committee's inquiries have turned up no evidence that the State Department today attaches more than routine importance to this ambassadorial function.

In the absence of detailed guidance or indication of support from Washington, ambassadorial performance varies widely. One Ambassador, who generally is known to "run a tight ship," exercises detailed supervision and control over the CIA Station. For example, he insists on knowing source identities and on approving any sensitive espionage operation in advance and CIA, or at least the Station Chief, has accepted such control. This Ambassador, a career Foreign Service Officer, tends to attribute his good working relationship with the CIA Station in large measure to the fact that he has had a great deal of prior experience with CIA in Washington and in the field. Such experience is clearly required by Ambassadors assigned to important countries, though in practice, the assignment of Ambassadors has not considerably reflected this requirement.

For whatever reason, this degree of detailed supervision appears to be unusual, if not unique. Our inquiries suggest that Ambassadors rarely seek to learn source identities. In this area they seem to be affected by what one Ambassador has called "self-inflicted intimidation." In one post—where there is a serious terrorist problem—the Ambassador explained that he preferred not to know source identities because of the possibility of being kidnapped. However, the same Ambassador has taken a very strong stand that control of communications is essential if the Ambassador is to exercise effective supervision over CIA. Still another senior Ambassador does not consider that control of communications would really ensure that the Ambassa-

dor knows everything that is going on. This Ambassador controls by what amounts to a threat; he informs each Chief of Station that he expects to be consulted in advance about any operation which could cause embarrassment. If any CIA operation about which he has not been consulted causes difficulties, the Station Chief can expect no support from the Ambassador. This would appear to be a more typical procedure.

It should be noted that these are techniques designed to forestall surprise and embarrassment. There is no body of doctrine or standards against which judgments can be made on whether to approve a given operation, nor are Ambassadors given any basic instruction on espionage techniques and risks. It is hardly surprising, therefore, if there is a wide variation in practice and that judgments tend to be *ad hoc* and subjective. This is not likely to change so long as the matter is left to individual Ambassadors.^{17a}

C. SUPPORT: COMMUNICATIONS

In the early 1960s, responsibility for most U.S. diplomatic communications was assigned to CIA. This came about as the result of a decision to bring about radical (and costly) improvements in existing facilities. It was judged that CIA could obtain the necessary funds more easily and quickly than State. Furthermore, CIA already had its own communication facilities, and, as it was accepted that the Agency would have to have such facilities in the future, it also seemed more efficient to give CIA responsibility for a single network serving both agencies. To permit some privacy in State communications, the new system provided for a State superencipherment capability.

The situation today is that State has access to CIA communications only as determined by CIA, whereas CIA has access to all State communications, except in those cases where State takes the initiative (and the trouble) to encipher the message giving it to CIA for further encipherment and transmission. Control of communication is a key element of command; the existing arrangements are not compatible with the role of the Ambassador prescribed in 22 U.S. 2680a. The Ambassador cannot be sure that he knows the full extent and nature of CIA operations for which he is held responsible by law.

D. PRODUCTION OF INTELLIGENCE

Surveys carried out by the Director of Central Intelligence make clear the importance of Foreign Service reporting in the production of national intelligence. In these surveys analysts are asked which collection sources had most often made a key contribution to the *National Intelligence Bulletin* and national intelligence memoranda and reports. The ranking reflects intelligence inputs regarded by the analysts as so essential that basic conclusions and findings could not have

^{17a} At the request of the CIA, the Committee has deleted a section of this report entitled "Support: Cover" to protect sensitive intelligence sources and methods. A classified version of this section is available to Members of the Senate under the provisions of S. Res. 21 and the Rules of the Senate.

been reached without them. The State Department's collection inputs have consistently led the ratings.¹⁸

Of course, collection of overt intelligence is only one function of the Foreign Service Officer, who is charged also with representation of U.S. interests, negotiations, etc. It is, in fact, the latter functions, which put him in contact with responsible and knowledgeable officials and politicians of the local government and with other diplomats, that give him access to the most important information. Foreign Service reporting generally includes analysis pointing up the significance of particular events. These factors probably account in large measure for the high ranking accorded FSO reports by the intelligence analysts.

In any event, the Committee has found no evidence of any correlation between the importance attached by the intelligence community to the Foreign Service collection operation and the application of resources in men and money to that operation. Indeed, political and economic reporting positions abroad have been steadily reduced for some years. In one major European country crucial to America's security there is only one Foreign Service political reporting officer located outside the capital due to such cutbacks. The Ambassador said that if he had additional resources, the first move would be to re-establish political reporting officers in the several consulates in the country. The Ambassador explained that by law the Foreign Service must carry out a number of consular functions and that with over-tightening resources the political reporting function has been squeezed out. The Committee determined, however, that the CIA has sufficient resources to consider a major new clandestine collection program in that same country.

For the past thirty years, the Department of State has been short of resources. Its reporting functions have been taken up by the relatively more prosperous CIA. Within State or in the intelligence community, there is no systematic or clear allocation of resources for the reporting task—except for commercial information. Overseas posts get a "representation allowance," generally meager, which is used in part to cultivate reporting sources and contacts but which also must be shared with other sections of the post, including the administrative and consular sections. When there is a choice between paying for the costs of a visiting distinguished official, such as a Congressman, or supporting the work of a junior political officer, the only source for this outlay is the so-called "representation fund."

The State Department's "representation allowance" is a favorite target for Congressional reduction in part because it has become synonymous with diplomatic "cocktail parties." As a result, the CIA with its "operational funds" and even the Military Attaches have a much greater degree of funding and flexibility. In one post, for example, the allowance of the Defense Attache nearly equaled that of the Ambassador and the political and economic sections combined. There is no separate fund to facilitate overt collection of political and economic information. The Department of State budget contains no line items for such purposes and continues to show only salaries and expenses with no indication of their objectives. The Department has

¹⁸ "Key Sources of Selected CIA Publications," Annual Survey done by Directorate of Intelligence of CIA (1975).

been unwilling to press the Congress for more funding, particularly for expansion of the so-called "representation allowance." As a result, the largest, most important, and least risky source of political and economic intelligence for the United States Government is neglected in the Federal budget and severely underfunded.

Secondly, the Department itself seems to have made little effort to direct the Foreign Service collection effort in a systematic way. The Department itself levies no overall requirements. Most regional bureau Assistant Secretaries send periodic letters to field posts indicating subjects of priority interest and these letters are supplemented by "official-informal" communications from the Country Director (desk officer). In addition the Department participates in the development of inter-agency intelligence requirement lists, and those lists are transmitted to the embassies and consulates abroad. The Department believes that these procedures suffice, and does not favor the development of a more elaborate requirement mechanism for the Foreign Service.

The Department has made no significant effort to train junior Foreign Service Officers in the techniques of political reporting. The record is somewhat better for economic reporting. A recent report of the Department's Inspector General concluded that the Department has generally been remiss in setting and maintaining professional standards through systematic training, assignment, and promotion policies. These judgments go well beyond the mandate of the Select Committee, but the Committee would strongly endorse measures designed to maximize the usefulness of this key collection source.

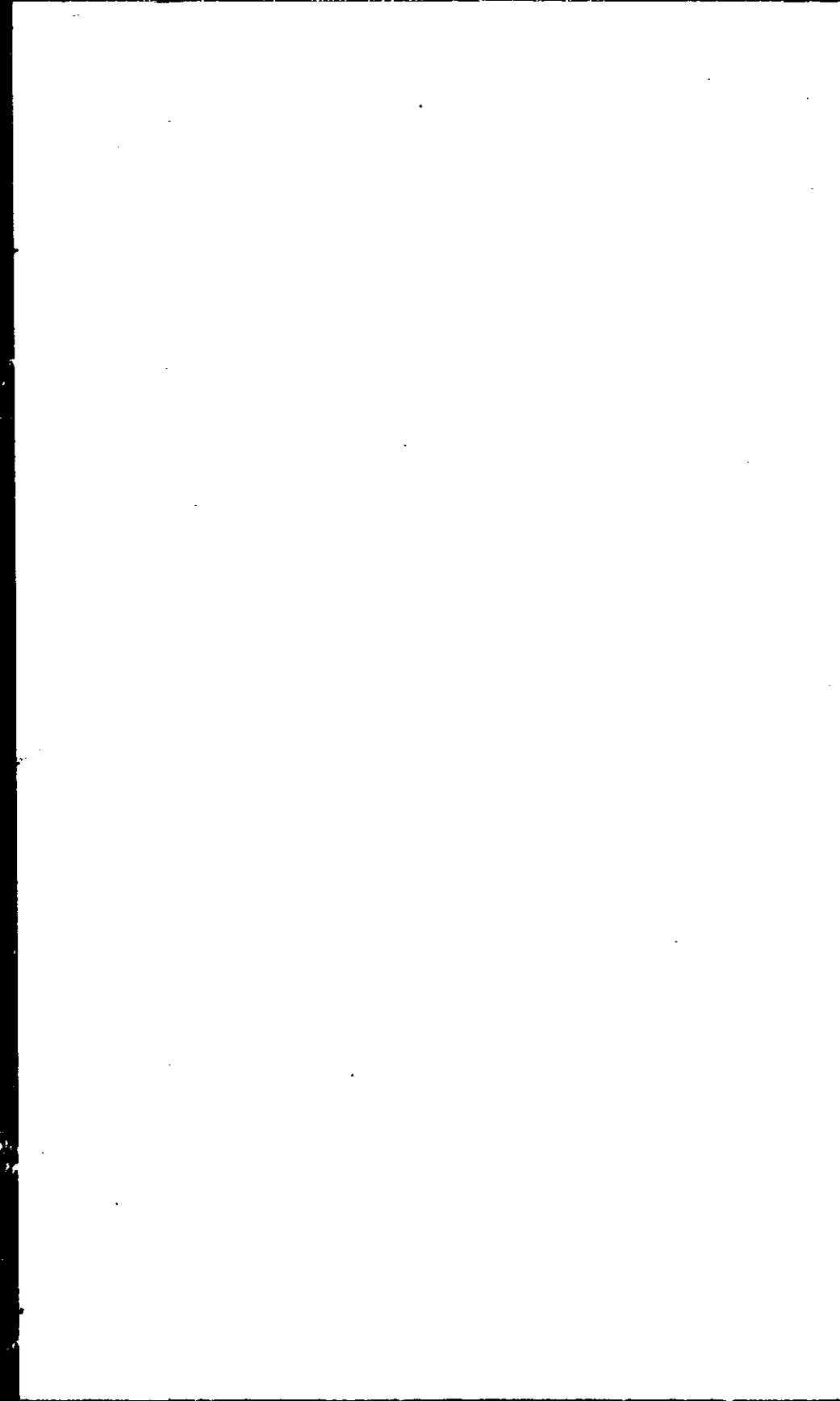

XV. DEPARTMENT OF DEFENSE

The Department of Defense is the nation's primary consumer of intelligence information. It controls nearly 90 percent of the nation's spending on intelligence programs, and most technical collection systems are developed, targeted, and operated by DOD personnel. The sheer size and complexity of the Defense intelligence establishment make it difficult to comprehend the problems and issues which confront policymakers and intelligence managers. Overall security needs and bureaucratic interests, as well as differing intelligence needs, further complicate the quest for solutions to the community's substantive problems and impede efforts aimed at implementing management reform.

This section of the report summarizes the Committee's investigation into the intelligence activities of the Department of Defense. It is limited in content to information that can be released publicly. Although many significant factual details about the national intelligence apparatus are thus not included, the Committee does not believe that such omissions seriously detract from a clear presentation of the central findings of its work.

The Committee focused on national intelligence activities, i.e., those which produce information primarily of interest to national decision-makers. Tactical intelligence activities, which are organic to or in direct support of operational units, received less attention. This area could not be ignored, however, because new collection and processing technology has significantly affected the relationship between the national intelligence systems and the operational commands.

After an initial review of the entire defense intelligence program, based on documents, briefings, and studies provided by the executive branch, the Committee investigated the following issues of particular interest:

- The resource management and organizational dimensions of the Defense national intelligence community.
- The role of the Defense Intelligence Agency in relation to the CIA and intelligence functions of the military departments.
- The monitoring and reporting activities of the National Security Agency.
- Military counterintelligence and investigative activities of the Department of Defense.
- The chemical and biological research of the Department of Defense as it relates to intelligence missions.

The investigation revealed abuses of authority in all these subject areas, some of which were already known to the intelligence community, Congress, or the public. After a brief review of the relation

of intelligence to the major objectives of U.S. military forces, and the history and evolution of intelligence organizations, this report addresses these specific Defense intelligence issues in turn. The concluding section assesses the future requirements for Defense intelligence, particularly as they are affected by technological developments.

A. OBJECTIVES AND ORGANIZATION OF THE DEFENSE INTELLIGENCE COMMUNITY

The mission of the Department of Defense intelligence apparatus is to provide the defense establishment with accurate and timely information on the military capabilities or political intents of foreign states to assure that U.S. policymakers are forewarned of, and U.S. military forces prepared for, any event which threatens the national security.

There are several important consumers of Defense intelligence. National security policymakers are interested in three areas of national importance: crisis management, which calls for not only advance warning of possible military, economic, or political disruption, but also continued, detailed tracing of developments once they are underway; long-range trends in foreign military, economic, and scientific capabilities, and political attitudes which might warrant a major U.S. response; and the monitoring or verification of specific international agreements which are either in force, such as the SALT agreement or the Middle East ceasefire, or contemplated, such as Mutual and Balanced Force Reductions talks in Europe.

Defense planners, responsible for designing the structure of U.S. military forces, constitute a second important group of intelligence consumers. Although their interests are less far-ranging than those of the policymakers, their demands for insights into the capabilities of opposing military forces are generally phrased in broader terms than other DOD intelligence consumers, if only because the macroscopic analysis which supports major force structure decisions is seldom sensitive to detailed intelligence inputs.

In contrast to the estimative character of the intelligence products most required by policymakers and defense planners, two other consumer groups, the developers of weapon systems and the operating field forces, have greater interest in detailed, factual information. Satisfaction of these demands is generally more a matter of collection and compilation than analysis and inference. The major distinction between the two groups lies in their subject interests. The weapon systems developers emphasize scientific and technical detail regarding the operating characteristics and performance parameters of foreign weapon systems (knowledge of which can be useful in optimizing the design of U.S. systems). The military field commands emphasize "order of battle" data, or the unit identities and the strength, equipment, and disposition of opposing field forces.

The sequence of operations in meeting the intelligence demands of these disparate groups of consumers involves three (or, in the case of signals intelligence, four) basic steps: (1) collection—the gathering of potentially relevant data; (2) production—the translation of

these data into finished intelligence products through screening, analysis, and drawing of inferences; and (3) dissemination—delivery of the finished products to the right consumers at the right time. If the collected data are in the form of electronic signals, another step, "processing," between the first and the second, is required to refine the raw signals before they are submitted for human evaluation during the production phase.

A brief review of the major objectives of U.S. military forces may help to place the intelligence contribution in perspective.

1. Objectives of U.S. Military Forces

The paramount objective of U.S. forces is to deter nuclear attacks upon the United States and its allies by maintaining an unambiguous capability to inflict massive damage on the attacker, even after absorbing a first strike by the aggressor's nuclear forces. The defense intelligence community supports this objective by monitoring the technical developments and force deployments of potential enemies, especially those which might attempt to gain the capability for a disarming first strike. U.S. technical collection systems are able to alert leaders to an imminent attack by detecting movement or changes in the status of the Soviet Union's strategic forces. Thus warned, the United States can counter and react to such changes. This so-called strategic warning may be essential to the survival of some components of the U.S. retaliatory force.

Tactical warning, based on indications that a nuclear attack has actually commenced, is the primary responsibility of the alert and warning networks of the operational military commands. Although U.S. intelligence collection systems are not designed specifically to provide such warning, they have some inherent ability to do so. It is generally agreed that no measures would prevent a nuclear exchange from devastating all the participants; thus, relatively little attention has been devoted to developing intelligence systems designed to improve the outcome of an all-out nuclear war for the United States or its allies.

The second purpose of U.S. forces is to deter conventional (i.e., non-nuclear) military attacks on its allies. Although U.S. nuclear forces, both strategic and theater, contribute to this objective by introducing the threat of escalation into a potential aggressor's calculation, the general purpose forces (land combat, naval, and tactical air) of the United States and its allies are considered the prime deterrent to conventional military attack. Planning for the general purpose forces focuses on being able to defend Western Europe, while at the same time being able to conduct a lesser war in the Pacific theater. Again intelligence plays an important role in following the technical and force-level changes of potential enemies, and in predicting future trends. Current intelligence is also relied upon to provide adequate warning of the massive redeployment of men and materiel that would precede a conventional attack.

In the event of war, it will be critical to adapt the missions of the national intelligence-gathering systems to the needs of operational commanders. The planning for such contingencies poses a major challenge for leaders of the defense intelligence community.

The ongoing arms limitations negotiations on strategic and theater forces in Europe are guided by the principle of rough equality between opposing capabilities. Asymmetries in such factors as geography, technology, and manpower must be accommodated so that both sides believe there is an overall balance. Intelligence systems play a critical part in monitoring this balance since they are the only reliable means available for verifying the status of forces of potential adversaries. In fact, advances in technical intelligence collection systems have made the current arms limitation agreements feasible. Establishing compliance with the strategic arms agreements in force, as well as providing assistance in current negotiations, is now among the most vital missions of the national intelligence apparatus.

The technical capabilities of U.S. intelligence systems are probably now adequate to meet the demands of present agreements. Whether they can meet the needs of future agreements is unclear and dependent upon the specific terms negotiated. Some of the proposals advanced in connection with the Vladivostok Agreement and the Mutual and Balanced Force Reduction (MBFR) talks would test the abilities of current or envisioned intelligence systems to detect or verify with high confidence. Three of the most difficult enforcement areas which could arise under future agreements and which pose major problems for the intelligence community are:

- MIRV missiles which are concealed in silos or submarines;
- Cruise missiles whose launchers are easily concealed in bombers and submarines, and which may carry either conventional or nuclear warheads;
- Mobile forces and weapons (particularly nuclear systems) in Europe which can be transferred quickly to and from the theater, and are also readily concealed.

2. Evolution of Defense Intelligence Organizations

The complexities of modern defense have burdened the intelligence community with issues and responsibilities which could hardly have been anticipated when the United States emerged as the world's foremost military power three decades ago. In endeavoring to fill its expanding role in support of the nation's security interests, the defense intelligence apparatus has undergone periodic reorganization, generally leading toward more centralized management control. The desire to make the defense intelligence community more responsive to the needs of policymakers has motivated this trend.

At present, the most likely near-term prognosis is for a continuation of the general peace, interrupted at times by regional conflict and crisis, but not erupting into a major war or likely to involve direct U.S. military participation. The problem has been that in order to avert the big war, the U.S. has had to project a credible appearance of being able to win it, or, at least, not lose it decisively. This means it could not permit its war-fighting capacity, for which the military services hold the final responsibility, to erode unilaterally. Since the defense intelligence apparatus is a major contributor to that capacity, and since most of the important intelligence assets are operated by the armed forces, it is not surprising that the services have resisted efforts to channel these resources in different directions.

The existing organization of the defense intelligence community will be discussed in the following section. It is important to appreciate that it was not designed expressly to serve today's intelligence requirements or to manage today's intelligence functions. Rather, it should be perceived as basically a service to the military, adjusted through several decades of institutional compromise.

3. Early Beginnings

The first traces of U.S. military intelligence activities appeared in the Revolutionary War, when General George Washington, as commander of the colonial Army, recruited and trained a corps of intelligence agents to report on British activities. This effort, which included the use of codes, secret ink, and disguises, was short-lived, and the agents were mustered out of service with the rest of the Continental Army. Following Washington's precedent, commanders of U.S. military forces in later conflicts created *ad hoc* intelligence units on their own authority to serve their individual needs. Andrew Jackson had an intelligence operation in the War of 1812, and Winfield Scott had an intelligence unit in his command in the Mexican War. A number of the military commanders in the Civil War organized their own intelligence networks, and two autonomous organizations, both named the United States Secret Service, engaged in intelligence activities for the Union, although neither had any legal authority to operate.

In 1882, the Secretary of the Navy established an Office of Naval Intelligence to collect and record "such naval information as may be useful to the department in the time of war, as well as in peace."¹ This office developed a naval attache system to overtly collect information on foreign naval activities. It initiated a series of publications summarizing the information it had collected to keep the Navy abreast of foreign naval developments, and specifically provided the Naval War Board with information during the Spanish-American War.

The first comparable Army unit was the Military Intelligence Division of the Office of Adjutant General, established in 1885 to gather information on foreign armies. It, too, was active during the Spanish-American War, but by the outbreak of World War I the entire Division had shrunk to two officers and two clerks.

Both the Army and Navy greatly expanded their intelligence complements during World War I. The Army alone had more than 300 officers and 1,000 civilians engaged in intelligence work. In 1917, a War Department Cipher Bureau was created by administrative directive. This unit, sometimes referred to as the "American Black Chamber," solved more than 45,000 cryptograms (including one from the Sunday Times) and broke the codes of more than twenty nations. It was dissolved at the specific direction of Secretary of State Henry L. Stimson in 1929, who reportedly said: "Gentlemen do not read each other's mail."² This and similar measures left the service intelligence arms poorly prepared for World War II.

¹A. P. Niblack, *The History and Aims of the Office of Naval Intelligence*, Division of Operations, United States Navy Department (Washington, D.C.: U.S. Government Printing Office, 1920).

²Herbert O. Yardley, *The American Black Chamber* (Indianapolis: Bobbs-Merrill, 1931), pp. 332, 348.

One of the first steps taken by President Roosevelt in the aftermath of Pearl Harbor was to order the creation of the Office of Strategic Services (OSS) in June 1942 under the direction of General William Donovan. During World War II, OSS, together with the Army and Navy intelligence organizations, was coordinated by the Joint Intelligence Committee of the Joint Chiefs of Staff.

A list of the functions of the principal OSS branches demonstrates the scope of its activity. The Research and Analysis section produced economic, military, social, and political studies, and estimates for strategic areas from Europe to the Far East; the Secret Intelligence group gathered information from within neutral and enemy territory; Special Operations conducted sabotage and worked with the various resistance groups; Counterespionage protected United States and allied intelligence operations; Morale Operations created and spread "black propaganda"; Operational Groups trained, supplied, and sometimes led guerrilla groups in enemy territory; the Maritime Unit conducted marine sabotage; and Schools and Training was in charge of the overall training and assessment of personnel, both in the United States and abroad. In addition, OSS was directed to plan and conduct such "special services as may be directed by the United States Joint Chiefs of Staff." Only Latin America, the FBI's bailiwick, and the Pacific Theater, General MacArthur's, were outside the OSS sphere of operations.

Jurisdiction over subjects of tactical military interest, such as order of battle data and enemy weaponry estimates, was left with the traditional service arms. OSS also did not prevail completely over other intelligence operations of the services, which achieved a number of notable wartime successes. Army Intelligence, for example, captured a high-level Nazi planning group in North Africa, obtained a map of all enemy minefields in Sicily, and captured the entire Japanese secret police force on Okinawa. Naval Intelligence, soon after United States' entry into the war, deduced the impending appearance of German guided missiles, such as the HS 203, the V-bombs, and homing torpedoes.

After World War II, President Truman issued an Executive Order abolishing the OSS on September 20, 1945. The Department of War absorbed some of its functions, such as the work of its Secret Intelligence group and of its Counterespionage program. The State Department assumed others.

The demise of the OSS did not, however, end the concept of a central intelligence organization. On January 22, 1946, President Truman established a National Intelligence Authority to advise him, and created a Central Intelligence Group to assist the NIA in coordinating national intelligence matters. These two organizations evolved, through the National Security Act of 1947, into the National Security Council and Central Intelligence Agency.

The rapid demobilization of the armed forces after the war, the creation of the first peacetime central intelligence organization, and President Truman's conviction that the military must be subordinated to civilian control were all factors which seemed to portend a diminished role for the armed forces within the post-war intelligence community.

The National Security Act of 1947, which created the CIA and NSC, also strengthened civilian authority over military services by drawing the War and Navy Departments together under a single Secretary of Defense. The new Secretary was given authority over all facets of the administration of the defense establishment. The identities of the Army and the Navy were preserved, however, under separate civilian secretaries who now reported to the Secretary of Defense rather than directly to the President. At the same time, the air elements of the Army were reformed under a new Department of the Air Force, with the same status as the two older service departments.

The broad powers granted the Secretary of Defense permit him to effect major organizational changes within the Defense Department by the simple expedient of issuing a directive. The Defense Intelligence Agency was created by such a directive in 1961. The Eisenhower administration had concluded in the late 1950s that a consolidation of the services' general (defined rather awkwardly as all non-SIGINT, nonoverhead, nonorganic intelligence activities) was needed, an idea which the Secretary of Defense in the new Kennedy administration, Robert F. McNamara, quickly endorsed.

The Joint Chiefs of Staff and Secretary McNamara disagreed on the form the new agency should take. The JCS were concerned with preserving the responsiveness of the service efforts to the military's tactical intelligence requirements. They therefore wanted a joint Military Intelligence Agency subordinate to them, within which the independence of the several military components, and hence their sensitivity to the needs of the parent service, would be retained.³ McNamara wanted a much stronger bond. He was determined to utilize better the service assets to support policymakers and force structure planners, and to achieve management economies.

The Defense Intelligence Agency which emerged was a compromise. It reports to the Secretary of Defense, but does so through the JCS. The Joint Staff Director for Intelligence (the J-2) was abolished and replaced by the Director of the new DIA. The functions of the Office of Special Operations—the small intelligence arm of the Office of the Secretary of Defense (OSD)—were absorbed by DIA.⁴ There has been continuing controversy among the services due to their reluctance to cede responsibilities to DIA because they feared downgrading wartime combat capabilities. Moreover, the OSD level of the Defense Department has pressed continuously for greater centralization; both of these controversies have hampered DIA throughout its existence.

Unlike the DIA, the National Security Agency (NSA) is a presidential creation. Established in response to a Top Secret directive

³ Memoranda, from Secretary of Defense Robert McNamara to Chief, Joint Chiefs of Staff, Lyman Lemnitzer, 2/8/61; from Lemnitzer to McNamara, 3/2/61; from McNamara to Lemnitzer, 4/8/61; from Lemnitzer to McNamara, 4/13/61.

⁴ Memorandum from Deputy Secretary of Defense Roswell Gilpatric to Secretaries of the Military Departments; Director of Defense Research and Engineering; Chief, Joint Chiefs of Staff; Assistant Secretaries of Defense; General Counsel; Special Assistant; and Assistants to the Secretary, 7/5/61, DOD Directive 5105.21, 8/1/61.

issued by President Truman in October 1952, NSA assumed the responsibilities of its predecessor, the Armed Forces Security Agency (AFSA), which had been created after World War II to integrate the national cryptologic effort. NSA was established as a separate agency within DOD reporting directly to the Secretary of Defense. In addition, it was granted SIGINT operational control over the three Service Cryptologic (collection) Agencies (SCAs): the Army Security Agency, Naval Security Group Command, and Air Force Security Service. Under this arrangement NSA encountered many of the same jurisdictional difficulties which were to plague DIA. In an effort to strengthen the influence of the Director of the National Security Agency (DIRNSA) over their activities, the SCAs were confederated in 1971 under a Central Security Service (CSS) with the DIRNSA as its chief. The mission of NSA/CSS is to provide centralized coordination, direction, and control for the United States Government's Signals Intelligence (SIGINT) and Communications Security (COMSEC) activities.

4. Current Organization

Describing the management structure of the Defense intelligence community would be a difficult task under the best of circumstances. Authority and influence within any big organization are often determined as much by personalities and working relationships as by formal chains of commands or job descriptions. For the sprawling and complex Defense intelligence network, the task is particularly challenging. Moreover, the community is in the midst of an executive branch-directed transition which may alter second-level management relationships throughout the Department of Defense. The executive branch has not yet revealed exactly what kind of structure it intends, if indeed its full reorganization plan has been decided.

Of necessity, the description which follows applies to the organization of the Defense intelligence community as it existed during most of 1975.⁵

As the Defense intelligence community is presently organized, the Secretary of Defense has three groups of assets: (1) the Defense agencies reporting directly to him, of which the National Security Agency, the Central Security Service, and classified national programs are the most significant (but also including the Defense Mapping Agency and the Defense Investigative Service); (2) the Defense Intelligence Agency, which reports to him through his principal military advisers,

⁵ The most significant change apparently now being considered would affect the Office of the Assistant Secretary of Defense for Intelligence (ASD/I). This position is currently (as of April 1976) vacant. Reportedly, the duties of the ASD/I will be assumed by a new Deputy Secretary who will also have executive jurisdiction over the related fields of telecommunications and net threat assessment. In this case, the ASD/I position could be abolished. The possibility cannot be ruled out, however, that the executive envisions the new Deputy Secretary as an additional oversight position, in which case a new ASD/I reporting to him could be appointed. This is along the lines suggested by the Report to the President and the Secretary of Defense by the Blue Ribbon Defense Panel, July 1, 1970, on National Command and Control Capability and Defense Intelligence (hereinafter cited as the Fitzhugh Report, after its chairman, Gilbert W. Fitzhugh).

the Joint Chiefs of Staff, and is responsible for preparing Defense intelligence reports and estimates drawing upon the data collected by other arms of the intelligence apparatus; and (3) the intelligence arms of the individual military services under the immediate operational control of the service chiefs, which encompass the military's general intelligence collection agencies, their counterintelligence and investigative arms, and activities of tactical interest.

One of the largest organizations in the Defense intelligence community is the National Security Agency. Military personnel, facilities, and equipment play a predominant role in carrying out the mission described by NSA Director, General Lew Allen, Jr., in public session:

This mission of NSA is directed to foreign intelligence, obtained from foreign electrical communications and also from other foreign signals such as radars. Signals are intercepted by many techniques and processed, sorted and analyzed by procedures which reject inappropriate or unnecessary signals. The foreign intelligence derived from these signals is then reported to various agencies of the government in response to their approved requirements for foreign intelligence.⁹

Other agencies reporting directly to the Secretary of Defense are concerned with more specialized subject areas than the cryptologic group and make smaller demands on resources. The Defense Mapping Agency is responsible for all defense mapping, charting, and geodetic activities. Although a substantial percentage of this Agency's activities are of vital intelligence interest, others are related only marginally to intelligence, and some have no defense connotation at all. Similarly, the Defense Investigative Service, responsible for carrying out background investigations, is generally not considered in the mainstream of the national intelligence effort.

Aside from the Defense Investigative Service, each of the military services retains independent investigative arms responsible for both counterintelligence and criminal matters. These agencies fall within the ordinary military chain of command, and report to the Chief of Staff for each service. Other intelligence activities of national importance conducted under the uniformed services include the reconnaissance operations of Air Force aircraft and drones, and the general intelligence collection and analysis work of the U.S. Army Intelligence Agency, the Naval Intelligence Command, and the Air Force Intelligence Service. The service intelligence agencies are primarily oriented to supporting the tactical missions of the services, but they also collect information used by DIA in producing finished intelligence. The service agencies also continue to engage in activities related to national intelligence, and participate in the national estimates process as observers on the U.S. Intelligence Board.¹⁰

A simplified diagram of the DOD-funded intelligence organization is presented on page 328. As is clear from the diagram, the organizational structure is extremely complicated, with several key individuals serving in more than one capacity, and disparate and diffuse chains of responsibility, both for deciding what is to be done and allocating the resources to do it.

⁹ General Lew Allen, Jr., testimony, 10/29/75, Hearings, Vol. 5, p. 17.

¹⁰ USIB was abolished by Executive Order No. 11805, 2/18/70.

ORGANIZATION OF THE BUDGETED INTELLIGENCE COMMUNITY

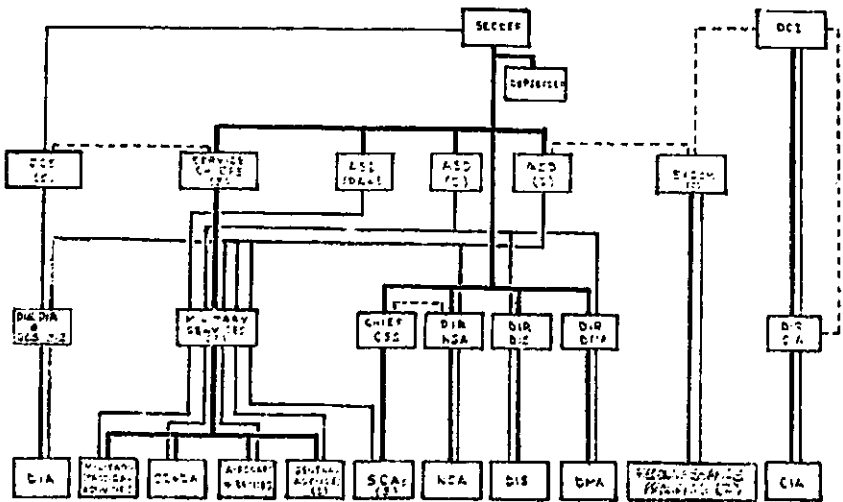

ORGANIZATION January
 SECRETARIES January
 IDENTIFIED January

Perhaps the most significant feature of the above chart however, is what it does *not* show: a clear-cut line of authority extending from the highest councils of the executive branch to the operating arms of the intelligence apparatus. This is not surprising since this structure is the product of many years of bureaucratic evolution. Whether one views this arrangement as a crazy-quilt pattern, produced piecemeal over time in response to internal pressures, or as a finely balanced mechanism developed to meet needs as they arose, is largely a matter of perspective. It is hard to avoid observing, however, that if the apparatus has functioned even half as efficiently in allocating intelligence resources as its proponents maintain, it is because its participants have come to understand it well enough to make the system work in spite of itself. On the brighter side, the profusion of checks and balances inherent in the system may serve to reassure those who fear the potential evils of concentrating too much power in the hands of a single intelligence leader.

B. THE DEFENSE INTELLIGENCE BUDGET

1. Problems of Definition

The magnitude of national resources devoted to intelligence activities has recently been subject to considerable public speculation. Estimates of U.S. military intelligence spending have ranged from \$3-4 billion annually to \$15 billion, with most settling around the \$6.2 billion figure cited in a recent book.⁷

⁷ Victor Marchetti and John D. Marks, *The CIA and the Cult of Intelligence* (New York: Dell, 1974), p. 95.

Much of the controversy stems from definitions. What constitutes an intelligence activity? Which Government entities are intelligence organizations? Unfortunately, the budgeting practices of the intelligence community, and particularly the Department of Defense which controls the overwhelming bulk of intelligence resources, were not designed with much attention to functional clarity. Within DOD, institutional pressures to lower the "fiscal profile" of intelligence activities and rivalries over control of organizational assets have led to such discrepancies as placing the SR-71 program in the strategic forces account (Program I, a totally different section of the Defense budget).⁸ Other examples of current budget practices are the exclusion of all communications security, counterintelligence, and mapping and charting activities from the Consolidated Defense Intelligence Budget (CDIB).

Although a case can be made that DOD's narrow definition of intelligence activities offers certain management expediciencies in permitting the staff of the Assistant Secretary of Defense for Intelligence (ASD/I) to concentrate its attention on the central elements of the Defense intelligence effort, it produces such functional anomalies as the exclusion of important intelligence activities from the ASD/I's fiscal purview. Certainly, whatever degree of budgeting oversight the Congress elects to assume should address a fiscal presentation assembled on the basis of a more comprehensive definition of national intelligence activities than DOD uses at present.

Furthermore, a congressional oversight committee, in attempting to monitor DOD's counterintelligence budget, may want to group it with the counterintelligence budgets of all other intelligence agencies to provide management visibility to the national counterintelligence effort that is now lacking, even within the executive branch. Practical difficulties in distinguishing counterintelligence activities from ordinary criminal investigations (which, though totally different in purpose, are quite similar in method and often share common assets) should not be permitted to preclude an effort to establish a cross-agency grouping of the counterintelligence budget.⁹

The same problem of distinguishing intelligence and nonintelligence-related functions exists in the budgets for mapping and geodetic activities, most of which are the responsibility of the Defense Mapping Agency. Many of DMA's missions are only marginally related to the intelligence function, but others are of vital importance to all segments of the intelligence community's market. At a tactical military level, what intelligence commodity is of greater importance to a field commander than accurate maps of his area of operations? As with counterintelligence, the difficulties inherent in trying to separate the budgets of those facets of the mapping, charting, and geodetic effort which serve a national intelligence purpose from those

⁸ The SR-71s were recently transferred from this category to the Strategic Forces (Program I in the Planning, Programming, and Budgeting System).

⁹ The investigations for security clearances, previously a hodgepodge of disparate standards for uncoordinated, redundant efforts, were recently consolidated under a newly formed Defense Investigative Service (DIS). Nearly two-thirds of the budget for Counterintelligence and Investigative Activities (CI&IA) remains vested with the service agencies.

which do not should not be solved by the simple expedient of ignoring all such activities.

Still more difficult definitional problems arise when one probes more deeply the budgets of the armed forces in search of "tactical" as opposed to "national" intelligence functions. The difference between these two categories of intelligence lies in the eye of the consumer, not in the intelligence-collection activity itself. Increasingly, intelligence data-collection systems have grown capable of serving both the broad interests of the policymakers and defense planners and the more specific technical interests of the weapons developers and field commanders. In fact, a given set of collected data may often be of interest to all these groups, although the analytical slant with which it is presented is likely to differ markedly in response to consumer preferences.

There is an extensive gray area encountered in attempting to define military intelligence activities at the tactical or field command level. Many components of the military forces make a definite contribution to our intelligence effort during peacetime, but have other important missions as well, particularly during war. A prime example is the Navy's long-range, shore-based patrol planes, which play an important ocean surveillance role in peacetime, but would be an active part of U.S. antisubmarine warfare (ASW) combat forces during war. Although tactical military intelligence and related activities are included in the comprehensive cost estimates presented in the following section, the Committee believes the budgets of such activities should be excluded from the jurisdiction of a congressional intelligence oversight committee, with those committees in which it is currently vested retaining fiscal review authority.

The problem of reflecting costs of activities which are only partly intelligence-related in cost reporting is not confined to DOD. The diplomatic missions of the Department of State are responsible for political, economic, and commercial reporting, as well as normal representational and diplomatic responsibilities. The Department's Bureau of Intelligence and Research, which is both a consumer of intelligence and a producer of finished analyses, was budgeted for \$9.5 million in FY 1976, of which 84 percent was spent on salaries. However, much more is spent each year to support State's embassies and consulates which, in addition to other duties, function in their political reporting activities as a human intelligence collection system. As with tactical military intelligence activities, the difficulties of trying to segregate the intelligence portion of the budget costs of these dual-purpose assets appear to outweigh the benefits.

2. The Size of the Defense Intelligence Budget in FY 1976

The Committee's analysis indicated that [deleted] billion¹⁰ constitutes the direct costs to the U.S. for its national intelligence program for FY 1976. This includes the total approved budgets of CIA, DIA, NSA, and national reconnaissance programs.^{10a} If the costs of tactical

¹⁰ Deleted pending further Committee consideration.

^{10a} Direct costs of the intelligence activities of the ERDA, FBI, and State Department are contained in their respective budgets.

intelligence by the armed services and indirect support costs^{10b} which may be attributed to intelligence and intelligence-related activities are added in, the total cost of intelligence activities by the U.S. Government would be twice that amount. This represents about [deleted] percent of the federal budget, and [deleted] percent of controllable federal spending.^{10c}

It should be stressed that this larger estimate represents a full cost and includes activities which also fulfill other purposes. Thus the entire amount could not be "saved" if there were no intelligence activities funded by or through the Defense Department.

A breakdown of the DOD intelligence budget divided by activity is shown in the table below. These estimates are based on a broader interpretation of what constitutes an intelligence activity than that used by DOD. The Department manages its national intelligence effort through the Consolidated Defense Intelligence Program (CDIP), and makes no formal effort to attribute indirect support costs. The summary includes only those activities funded through the Defense Appropriation Bill.

The costs of intelligence functions performed by the Departments of State (Bureau of Intelligence and Research), Treasury, Justice (Federal Bureau of Investigation), and the Energy Research and Development Administration (which has assimilated the intelligence division formerly operated by the Atomic Energy Commission) total about \$0.2 billion.

*Full Costs of Intelligence and Related Activities Within the DOD Budget:
Fiscal Year 1976*

(In millions)

Direct costs:

Cryptology
Communications security.....
Reconnaissance programs.....
Aircraft and drones.....
Special naval activities.....
Counterintelligence and investigation.....
General intelligence.....
Mapping, charting, and geodesy.....
Central Intelligence Agency.....
Subtotal, national intelligence effort.....	[deleted] ^{10d}
Strategic warning.....
Ocean surveillance.....
Tactical intelligence.....
Weather reconnaissance.....
Reserve intelligence components.....
Subtotal, military intelligence effort.....	[deleted]

 Total, direct costs..... [deleted]

Indirect support costs:

Basic research and exploratory development.....
Logistics.....
Training, medical and other personnel activities.....
Administration.....
Total, indirect support costs.....	[deleted]

 Total, intelligence costs (budgeted by DOD)..... [deleted]

^{10b} Indirect support costs include costs for personnel, operations and maintenance which support intelligence activities. Examples are the operation of training facilities, supply bases, and commissaries.

^{10c} Deleted pending further Committee consideration.

^{10d} *Ibid.*

[DELETED]

3. Who Controls the Intelligence Budget?

The nominal head of the intelligence community is the Director of Central Intelligence (DCI), who is also the Director of the Central Intelligence Agency; these two roles, however, are to be viewed as distinct. A cornerstone of President Nixon's 1971 directive, designed

to foster the intelligence community's responsiveness to policymakers and promote management efficiency, was "an enhanced leadership role" for the DCI. Yet the DCI was not given direct authority over the community's budget, nor granted the means by which to control the shape of that budget until the announcement of President Ford's Executive Order of February 18, 1976.

As Director of the CIA, the DCI controls less than 10 percent of the combined national and tactical intelligence efforts. His chairmanship of the Executive Committees (ExComs), which oversee the management of certain reconnaissance programs (wherein he serves in what amounts to a partnership with the ASD/I), also affords him some influence over the funds budgeted for these efforts. The remainder spent directly by the Department of Defense on intelligence activities in FY 1976 was outside of his fiscal authority. The DCI's influence over how these funds are allocated was limited, in effect, to that of an interested critic.

By persuasion, he could have some minor influence, but the budgets themselves were prepared entirely within the Department of Defense. The small staff of the DCI may have been consulted in the process, but by the time it sees the defense portion of the national intelligence budget, the budgetary cycle has been well advanced, and hence the budget has been largely fixed. Problems of timing also influence the role of the Office of Management and Budget, which sets broad fiscal guidelines in budget ceilings, but plays an otherwise minor role in shaping the Defense intelligence budget.

The real executive authority over at least four-fifths of the total resources spent on intelligence activities has resided with the Secretary of Defense. Over the past few years, the Deputy Secretary of Defense has shown a particular interest in the intelligence portion of the DOD budget, in effect representing the Secretary on many issues arising in this area. However, the major responsibility for management of intelligence programs will lie with the newly created position of Deputy Secretary of Defense for Intelligence (Mr. Robert Ellsworth).

The Assistant Secretary of Defense for Program Analysis and Evaluation (ASD/PA&E) holds general review authority over the so-called mission forces, the operational forces which include much of the tactical intelligence assets of the military services. A third ASD, the Comptroller, is responsible for reviewing the budgets of the agencies concerned with counterintelligence investigations, and the newly formed Defense Mapping Agency. As explained earlier, DOD considers these activities peripheral to the intelligence effort, and their costs account for only about 5 percent of the overall intelligence budget.

The managers of the various intelligence programs collectively wield the greatest influence on day-to-day intelligence operations. By the

budget yardstick, the most influential individual is the Director of NSA (DIRNSA) who, including his dual role as Chief of the Central Security Service, manages the largest single program contained in the national intelligence budget, less than half of which is actually in the NSA budget.

Close behind the DIRNSA, and also directly related to the collection of signals intelligence data, is the United States Air Force in its role of managing certain reconnaissance programs. Decisions made regarding the introduction and development of reconnaissance systems have the greatest impact on the overall size of the intelligence budget, not only because of the direct costs of perfecting and procuring the hardware involved—as expensive as this technically complex equipment has become—but also because of the continuing effect that the choice of a collection system has on processing and other operating costs long after it has been made.

A third grouping of defense intelligence activities is the General Defense Intelligence Program (GDIP). In effect an "all other" category, the GDIP budget is ordinarily one-fourth Defense Intelligence Agency (DIA) costs, and three-fourths service costs (including those of the Air Force Intelligence Service, Naval Intelligence Command, and a part of the U.S. Army Intelligence Agency). The GDIP encompasses all of DOD's non-SIGINT, nonoverhead intelligence collection and production activities deemed by the Department to be of national importance. It does not include activities related to the military field commands.

Although the general intelligence budget managed by the Director of DIA (DIRDIA) has never been more than a fraction the size of the DIRNSA's cryptologic budget, his problems, though similar, are more formidable. Whereas opinion is divided on the DIRNSA's grip over the service agencies that participate in the Consolidated Cryptologic Program (through the Central Security Service), there is little disagreement on the DIRDIA's inability to exert significant influence over the priorities and activities of the service components of the GDIP.

As a consequence, the program management responsibilities for the service general intelligence agencies previously held by the DIRDIA were recently transferred to the ASD/I. The result is that the DIRDIA, who purportedly still speaks for the Secretary of Defense on "substantive" matters within the intelligence community, exerts direct control over only 4 percent of the Secretary's intelligence budget.

The span of authority at each managerial tier—from executive oversight through fiscal review to program management—is summarized in the table on page 335.

Who controls the Intelligence Staff by
 Distribution of the 1976 Budget
 Request by Organization and Amount of Appropriated Funds
 (dollars in millions)

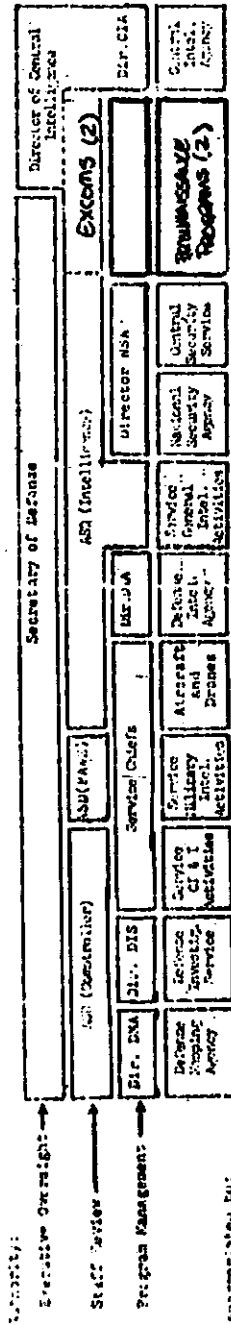

Appropriated by:

AR Force

ARMY

NAVY & Marine Corps

Air Force Academy

Total for Agency

[Figures deleted.]

Defense agencies each draw on resources funded within the service appropriations in addition to their own agency appropriations. These resources generally take the form of pay and allowances for military personnel who are serving tours outside their parent service with intelligence agencies. DIA's appropriation is supplemented by \$39 million in this way; NSA's by \$34 million; DIS by \$16 million; and the Defense Mapping Agency's by \$12 million. The Defense Department makes accounting corrections for these service-incurred costs in its Fiscal Year Defense Plan (FYDP), and the amounts are included in presenting the agency budgets. The important point to be recognized is that the budgets of the Defense intelligence agencies are not fully covered by the funds appropriated to them.

Slightly over a third of the overall DOD-funded intelligence effort is managed directly by the military services. The bulk of these funds support the tactical military requirements of the field commands and include many force components for which the intelligence mission is secondary or of shared importance with other activities. However, activities under service management are of national importance and interest in two areas: peripheral reconnaissance (carried out both by piloted aircraft, such as the SR-71, and unmanned drones), and counterintelligence and investigation (conducted by the Air Force Office of Special Investigations, the Naval Investigative Service, and a number of decentralized Army military intelligence groups).

4. Budget Trends

The preceding section defined a [deleted] billion "package" of DOD-funded activities as a reasonable, comprehensive estimate with the addition of selected non-defense activities of a national intelligence budget subjected to separate congressional authorization. This section focuses on budget trends for this grouping of national activities.

In terms of simple dollar amounts, the FY 1976 DOD budget submission for national intelligence activities is the highest ever—over twice the amount appropriated in FY 1962. During periods of rapid inflation, however, "current dollars" are totally misleading as a measure of time trends in the consumption of real resources. Some allowance must be made for the year-to-year diminution in the purchasing power of a dollar that is brought about by rising prices. The method for doing so employs "price deflators" in an effort to express the worth of a series of heterogeneous "current-year" dollars in terms of the purchasing power of a dollar in some specific "constant" base year. The fact that these adjustments can seldom be achieved with precision does not negate their usefulness.

The chart on page 337 indicates the trends in the DOD-funded national intelligence budget (which includes the CIA as well as Defense agencies and the national activities of the military services) from fiscal year 1962 through fiscal year 1976. The upper, climbing curve plots current dollar amounts as appropriated by the Congress except for fiscal year 1976, which is the amount requested by DOD. The lower, gradually descending curve shows the equivalent trend in the national intelligence budget after correcting, insofar as possible, for the effects of inflation by expressing each of the historical budgets in terms of the number of FY 1962 dollars it would take to purchase the same level of effort.

Trends in the National Intelligence Budget:

FY 1962-1976, A/

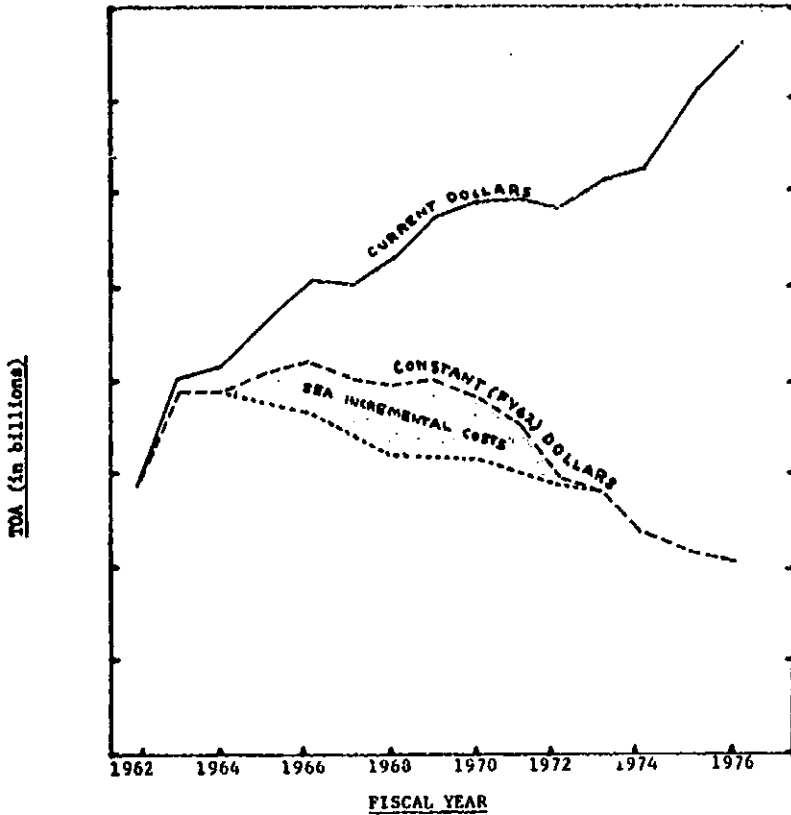

✓ Includes CIA budget. Does not include costs of tactical military intelligence activities.

After climbing rapidly during the first half of the 1960s, largely as a result of major program initiatives to acquire sophisticated reconnaissance systems (including the \$1 billion SR-71 development program), the real "baseline" intelligence budget peaked at mid-decade at about [deleted] billion. Although outlay continued to grow moderately for several more years, the extra cost of supporting activities directly related to the war effort in Southeast Asia grew even more quickly, so that the amount available to support nonwar-related, or baseline, activities began to diminish. Since the mid-1960s, the budget has declined steadily, in terms of the resources that could be bought with the dollars provided, to the FY 1976 level of [deleted] billion, about equal in buying power to the budgets of the late 1950s.

A review of DOD planning documents indicates that every effort will be made by Defense leaders to avoid further erosion in the intelligence effort below the FY 1976 level. Conversely, it is not anticipated that significant increases in funding (above those necessary to compensate for continued inflation, now expected to average 5-7 percent annually over the next five years) will be requested. If the Congress accepts these plans, a roughly constant level of real spending with gradually increasing annual appropriations to offset inflation can be expected.

Measured in today's prices, the budget request for Defense intelligence programs is also well below past funding levels: off \$0.5 billion, or about 10 percent, from the FY 1962 level, and down nearly 30 percent from the pre-Vietnam peak of [deleted] billion. Compared to FY 1962, the largest reductions have taken place in the resources dedicated to some activities under NSA's management, which declined by 31 percent in real terms; and the development, procurement, and operation of reconnaissance systems, which went down 15 percent. Spending in support of aircraft and drone operations, although far below the peaks associated with the introduction of the SR-71, stands well above the level of 1962. Spending for communications security is also considerably higher today. Reflecting efficiencies achieved through the consolidation of independent service programs within the Defense Mapping Agency, real spending for mapping, charting, and geodetic activities is about \$100 million less in FY 1976 than it was in FY 1962. Consolidation has also achieved economies in the field of counterintelligence and investigation, although on a far smaller scale. The \$125 million requested for these activities stands about 15 percent below the pre-Vietnam level of effort.¹¹

During the Committee's inquiry, informed managers within the Defense intelligence community frequently expressed the judgment that the downward trend in the resources dedicated to their programs has gone as far as it should. While acknowledging that no one has succeeded in devising a sound method by which to relate the value of the community's output to the quantity of resources used, they argue that most of the savings from the elimination of duplication and other forms of nonproductive effort have already been realized, and that further reductions can only be achieved at the risk of curtailing essential intelligence services.

5. How Much is Enough?

Because of the difficulties inherent in trying to quantify the intelligence community's output, no one has yet developed a rigorous method by which to relate the amount of intelligence produced to the amount of resources consumed in the intelligence effort. For this reason, it is not possible to state with confidence the effect that changes in the level of resources allocated to the intelligence mission could have on U.S. national security. In other words, no one really knows what comes out of the intelligence apparatus as a function of what goes into it.

The twin peacetime purposes for maintaining a national intelligence organization are to reduce the probability of key decisionmakers

¹¹ An estimated 20-40 percent of this amount will be spent for criminal, as opposed to counterintelligence, investigations.

making a wrong decision, either by taking inappropriate action in some matter important to U.S. interests or by failing to act at all, and to aid in assuring that U.S. Armed Forces are adequately prepared to execute decisions requiring military force. The intelligence apparatus is supposed to promote good policy and military readiness by making the policymakers and generals better informed than they might otherwise be. However, the relationship between the quality of the information supplied to a national leader and the quality of the decisions made is obviously extremely complex and ill-defined. Although good intelligence may create a bias in favor of policymakers making good policy, it can offer no guarantees that such will transpire in every instance. All too easily, a bad policy judgment may be attributed to "intelligence failures."

If the level of effort were increased substantially, the quality of intelligence and national security would be enhanced. Conversely, substantial reductions could pose additional security risks. What cannot be ascertained with precision is whether the benefits would be worth the additional costs, or the savings the additional risks. At present, the issue can only be evaluated subjectively, taking into account those few factual statements that are at hand and the judgments of intelligence experts (recognizing, of course, the institutional biases the judgments may reflect).

On the one hand, the way in which the peacetime national intelligence budget has been shrinking has been duly documented. Apparently, these reductions have not significantly detracted from the overall performance of the national intelligence apparatus or seriously jeopardized U.S. security. Community managers interviewed during the Committee's investigation generally felt that present funding was adequate to provide all consuming groups with essential intelligence support. On the other hand, the same individuals were unanimous in their opposition to any further cuts in the budget—a view endorsed by the 1975 report of the Defense Panel on Intelligence, which stated: "We consider that the widely held concern over the inflated size of the intelligence effort is no longer valid." The report maintained that further "substantial" reductions should be contingent on one or more of the following:

- A conscious decision to modify intelligence priorities and coverage.
- The introduction of labor-saving devices (i.e., automation of the intelligence process).
- Reorganization of other management efficiencies.

In making the case against further reductions in the level of the national intelligence effort, it is commonly argued that the intelligence is labor-intensive (meaning that people, not machines, contribute the most to the community's product and account for the greatest share of its costs), and that the number of intelligence workers has declined sharply over the past several years. The community's managers contend that further personnel cuts should be made only as new equipment is introduced which can do more efficiently some of the tasks now performed by people.

The trend in defense intelligence manpower has been sharply downward: the fiscal year-end strength of 89,000 persons (civilian and military, U.S. citizens and foreign nationals) planned for 1976 is one-fifth less than that of fiscal year 1962, and 42 percent below the 1968 peak of 153,800 persons (some of whom were, of course, engaged in support of the Southeast Asia war effort). At the end of fiscal year 1975, 101,500 persons were engaged in defense national intelligence activities.

It is not true that the defense national intelligence effort is labor-intensive. Quite the opposite. Intelligence is highly capital-intensive; the defense intelligence community annually invests more per employee than the DOD-wide average.¹² As shown in Table 5, investment per man-year for the national intelligence sector of the Defense budget will average \$16,700, about 11 percent less than was spent in 1962 despite the manpower reductions that have taken place, but still \$2,800 more than will be invested by the general purpose forces at large, and only \$1,800 less than the highly capital-intensive strategic forces. The downward trend in the investment rate for the intelligence components does not suggest a vigorous effort on the part of community managers to achieve the gains in efficiency through automation that they contend offer the best opportunity to realize further savings.

DEFENSE INVESTMENT RATES: FISCAL YEARS 1962-76
(Thousands of constant fiscal year 1976 dollars per man-year)¹

	1962	1964	1968	1972	1974	1975	1976	Percentage change, fiscal year 1962
Defense national intelligence components.....	18.7	22.0	15.3	14.8	14.8	16.3	16.7	-10.7
Strategic military forces.....	37.1	26.2	23.1	25.5	18.0	17.8	18.5	-50.1
General purpose military forces.....	12.1	12.4	15.9	13.1	12.1	10.0	13.9	+14.9

¹ Investment defined as sum of total obligations authority for associated RDT & E procurement and military construction. Average personnel strengths computed to include all military, U.S. civilian, and foreign national employees.

² These figures reflect increased investment in support of combat operations in Southeast Asia.

Lacking a sound methodology by which to relate outputs to inputs, management of the intelligence community must remain as subjective as the product in which it deals. The Committee did not receive the impression that the intelligence community was in fact striving to develop such a methodology, if indeed that is possible. The words of former Assistant Secretary of Defense Robert Froehle sum up the existing situation lucidly: "The intelligence community does not know the minimum level of resources that will satisfy an intelligence requirement. There is no upper boundary set by requirements, only by the resources that are made available."

¹²The Department of Defense has requested \$37.6 billion for investment (RDT&E, Procurement and Military Construction) in FY 1976 and will consume about 3.1 million man-years of labor for an average investment per man-year of \$12,000. This compares favorably with the most capital-intensive sectors of U.S. manufacturing, such as petroleum and chemicals, and is many times greater than the investment spending of such truly labor-intensive industries as textiles.

C. MANAGEMENT PROBLEMS OF THE DEFENSE INTELLIGENCE COMMUNITY

1. Previous Studies

Senate Resolution 21's instructions that the Select Committee undertake a "complete investigation and study" to determine "whether there is unnecessary duplication of expenditure and effort in the collection and processing of intelligence information by United States agencies" strikes a familiar chord. Over the past decade, no fewer than six major studies have been commissioned within the executive branch to probe precisely the same question. Coinciding with the Congress' inquiry, another executive study of the community's organization was conducted, culminating in the actions taken by the President on February 18, 1976.

Earlier studies have not always agreed on details, but all have concluded that the defense intelligence community has performed neither as effectively nor as efficiently as possible, due largely to its fragmented organization. More centralized management control is needed if there is to be improvement in the cost-effectiveness of the community's efforts. Notwithstanding this view, the community's organizational structure has changed little over many years. Since many of the past studies of the community's organization have tapped greater resources than have been available to the Select Committee, the discussion which follows draws heavily upon their findings.

Writing in 1971 from his vantage point in the Office of Management and Budget (OMB), James R. Schlesinger compared the structure and management methods of the intelligence community to those of the Department of Defense prior to the Defense Reorganization Act of 1958. Obviously, this Act did not eradicate all of DOD's management problems. Similarly, reorganization of the intelligence apparatus could not in itself guarantee improved performance nor lowered costs. But reorganization could, in Schlesinger's view, create the conditions for inspired intelligence leadership. In his 1971 paper, Schlesinger concluded: "the main hope for improving cost-effectiveness did in fact lie in a fundamental reform of the intelligence community's decision-making bodies and procedures."¹³

In its letter of transmittal to the President, the 1970 Blue Ribbon Panel on Defense (the Fitzhugh Report), summed up its appraisal of the community's performance with the following criticisms:

- Intelligence activities are spread throughout the Department of Defense with little or no effective coordination.
- Redundance in intelligence, within reason, is desirable, and it is particularly important that decision-makers have more than one independent source of intelligence.
- There is, as has often been charged, evidence of duplication between the various organizations.
- There is a tendency within the intelligence community to produce intelligence for the intelligence community and to remain remote from and not give sufficient attention to the requirements of others who have valid needs for intelligence.

¹³ Office of Management and Budget, "A Review of the Intelligence Community" (Schlesinger Report), 8/10/71.

—There is a large imbalance in the allocation of resources, which causes more information to be collected than can ever be processed or used.

—Collection efforts are driven by advances in sensor technology, not by requirements filtering down from consumers of the community's products.¹⁵

The Blue Ribbon panel also cited the following allegations made by "responsible witnesses" during the course of its investigation, noting that there was no way to confirm or disprove any of the charges because there was no existing procedure to evaluate systematically the efficiency of the intelligence process or the substantive value of its output:

—The human collection activities (HUMINT) of the services add little or nothing to the national capability.

—Defense attaches do more harm than good.

—The intelligence production analysts are not competent to produce a sound, useful product.

—Once produced, the product seldom reaches the individuals who need it.

Each of these issues is discussed below.

2. *Centralizing Management Controls*

On this issue, the views of those who wish to avoid repetitions of past abuses by the community and those stressing the importance of improving the effectiveness and efficiency of the community's operations may not be compatible. Critics of centralization feel that reforms aimed at improving cost-effectiveness by concentrating budget and operational authority within the community might, at the same time, concentrate the power to undertake improper activities in the future. Centralization proponents counter that the diffusion of authority is as apt to encourage improper conduct as its concentration. A streamlined management structure would, they argue, promote the visibility and accountability of controversial programs.

If the Defense intelligence community were reorganized to promote more effective, centralized controls, what form might it take?

The office of the Assistant Secretary of Defense for Intelligence (ASD/I) has been the single most influential office in the preparation of the national intelligence budget under recent organizational arrangements. Although the ASD/I's authority is not absolute, he has more to say about how and where the national intelligence community invests its resources than any other individual by virtue of his fiscal review authority over the Consolidated Defense Intelligence Program (CDIP).

ASD/I was established largely as a result of a recommendation by the 1970 Blue Ribbon Defense (Fitzhugh) Panel, but it was not accorded the full authority the Panel proposed, and certain other complementary reforms were also not adopted. A classified supplement to the Fitzhugh Report called for creation of an ASD/I who would also serve as a new Director of Defense Intelligence (DDI).

¹⁵ Fitzhugh Report, 7/1/70.

Under this arrangement, the same individual would have direct line authority over the operations of the DOD intelligence apparatus (via his position as Director of Defense Intelligence) and responsibility for review of resources allocated to it as Assistant Secretary of Defense for Intelligence.

The Blue Ribbon Panel further envisioned a reorganization of the DOD intelligence community along functional lines, separating collection and production activities into two new agencies, the heads of which would report to the ASD/I in his dual role as DDI.

Complementing its objective of creating a clear chain of command from the operating aims of the Defense intelligence establishment to the Department's top policymakers, the Panel also recommended the establishment of a Deputy Secretary of Defense for Operations who would represent the Secretary in all intelligence-related matters, and to whom the ASD/I-DDI would report directly. Although the recommendation to establish a second Deputy Secretary of Defense was not accepted in 1970, it is part of the 1976 executive reorganization plan.

3. Too Much Collection?

Numerous studies since the mid-1960s have concluded that a serious imbalance exists between the amount of data collected by the technical sensor and surveillance systems and the ability of the processors and analysts to digest and translate these data into useful intelligence information. These studies recommend that greater attention be given to producing better insights from the information and less to stockpiling data.

Analyzing the steep rise in the cost of intelligence activities during the 1950s and early 1960s, Schlesinger was among the first to blame the movement to employ ever more sophisticated technical collection systems, which he believed had led to "gross redundancies" within community operations. He concluded that the rapid growth in the collection of raw intelligence data was not a substitute for sorely needed improvements in analysis, inference, and estimation. The scope and quality of intelligence output, he concluded, had not kept pace with increases in its cost.

The Committee did not find any studies suggesting that more collection capacity is needed, although deficiencies in the responsiveness of existing collection systems have been frequently noted. Examples of general observations on overcollection are:

- Like the rest of the intelligence community, it (the CIA) makes up for not collecting enough of the right kind of information on the most important targets by flooding the system with secondary matter.
- The information explosion has already gotten out of hand, yet the CIA and the community are developing ways to intensify it. Its deleterious effects will certainly intensify as well, unless it is brought under control.
- The quantity of information is degrading the quality of finished intelligence.¹⁸

¹⁸ "Foreign Intelligence Collection Requirements: The Inspector General's Survey." (hereinafter cited as the Cunningham Report). December 1966.

—Production resources can make use of only a fraction of the information that is being collected. There exists no effective mechanism for balancing collection, processing and production resources.¹⁷

The period of rapid growth in intelligence costs that undoubtedly motivated much of the concern about overcollection has passed. Although the level of total real spending has now returned to what it was during the late 1950s, the efficiency with which intelligence resources are being apportioned among the collection, processing, and production functions remains an issue.

An examination of the distribution of the national intelligence budget dollar in FY 1975 indicates that most of the community's resources support collection activities. The community is still spending 72 percent of its funds for collection, 19 percent for processing raw technical data, and less than 9 percent for the production of the finished intelligence products (bulletins, reports, etc.) which the consumer sees as the community's output. There has been no significant change in the allocation over the past several years, nor is any anticipated.

The collection of unused information results in greater inefficiencies than merely the effort wasted on collection. Backlogs in processing and analysis lead to duplicative efforts across the board, since the results of preceding collection missions are not always available to plan and manage current missions. Moreover, the rush to keep pace with the data disgorged by the technical collection systems encourages superficial scanning, increasing the probability that potentially important pieces of information will be overlooked.

4. *Alternative Means of Collection*

There are major disagreements within the community between proponents of traditional collection methods employing undercover agents (human intelligence, or HUMINT) and advocates and operators of the vast system of technical sensors. Approximately 87 percent of the resources devoted to collection is spent on technical sensors, compared to only 13 percent for HUMINT (overt and clandestine operations).

Most of the intelligence experts interviewed during the Committee's inquiry tended to endorse the existing seven-to-one distribution of resources in favor of technical collection, but the efficacy of the technical sensors was not unanimously acclaimed. Deputy Secretary of Defense William P. Clements, Jr. commissioned the Defense Panel on Intelligence (1975)¹⁸ largely because of his concern with the failure of the analytical community to alert national leadership to the October 1973 Middle East war.

The Defense Panel Report stressed the importance of upgrading HUMINT, noting: "We are not getting [as of 1975] the level or quality of information we need from this source."¹⁹ The Report credited the CIA's Clandestine Service as the most competent U.S. HUMINT collectors, but held this arm was not very responsive to DOD needs. It

¹⁷ Fitzhugh Report, 7/1/70.

¹⁸ Report of the Defense Panel on Intelligence, 1/75.

was concluded that the principal Defense HUMINT collectors, the Defense Attaché System (DAS) managed by DIA, were yielding valuable returns at small cost, but greatly needed a personnel upgrading. Other critics have been less charitable to the attaches.

The problem of measuring intelligence output prevents accurate assessment of the contribution of different collection methods. Shifts in the uses of intelligence systems among peacetime, crisis, and wartime situations further complicate appraisals, as does the divergent interests of the national and tactical consumer groups. Civilian policymakers tend to plan for peacetime situations, whereas military commanders envision quite different wartime demands on the intelligence apparatus. The shifts of importance between peacetime and wartime are illustrated by the fact that much of the economic intelligence collected today would be accorded a much lower priority during a major war. Similarly, the verification of arms control agreements, now a major intelligence task, would be moot after the outbreak of hostilities between the major powers.

Against this backdrop, only an approximate evaluation of the comparative worth of the various methods of intelligence collection has been possible for the Committee. The results of such an evaluation are summarized as follows:

Performance was judged against two criteria: the ability of the method to accomplish specified intelligence objectives, and characteristics deemed desirable in intelligence systems.¹⁹

The analysis indicated that reconnaissance programs and SIGINT systems rank high in characteristics and performance. Not surprisingly, their costs are also the highest of all the competing systems.

HUMINT did not score as highly as might be expected, based on the emphasis and funds accorded to this activity. Still, overall, the evaluation indicated that a fairly good correlation exists between the benefits achieved by collection activities and their costs.

The priorities for spending among different collection systems appear to be appropriate. This does not mean that there is no need for adjustment in the pattern of resource allocation for collection methods. A major analytic effort on the part of the community offers the only means for achieving such efficiencies.

Although the issue of proper balance between collection, processing, and production is usually phrased in terms of overcollection, it might also be described as a problem of underproduction. Deputy Secretary of Defense Clements stated: "In every instance I know about where there was a horrendous failure of intelligence, the information was in fact available to have averted the problem. But the analysts and the system didn't allow the raw data to surface."²⁰

¹⁹ The following intelligence objectives are considered: strategic warning; crisis indication; foreign weapons development; foreign military deployments; political and military intent; economic information; political information; tactical military information.

The following characteristics were considered: ability to penetrate denied areas; accuracy and reliability of data; responsiveness; wartime survivability; peacetime risks of incident.

²⁰ Quoted by William Beecher in Report of the Defense Panel on Intelligence, 1/76.

Similarly, the Defense Intelligence Agency, the arm of the Defense Department charged with the prime responsibility for intelligence analysis and production, concluded in a 1973 report:

The great disparity in the relative national investment in collection systems versus intelligence processing, exploitation, production and support systems has now reached a platitude [*sic*] where the anticipated payoff of a high cost collection system is limited by the DIA's capability to exploit them [*sic*] fully.

If production is the limiting step in the intelligence sequence, improved overall efficiency might be achieved by enhancing this capacity as well as by cutting back on collection. It is not clear, however, that the DIA's suggestion to spend more on production, implied in the above passage, would solve the largely qualitative shortcomings now limiting the performance of some intelligence producers.

5. *Setting Intelligence Priorities*

Intertwined with the issue of how much should be spent on intelligence activities is the question of how best to spend it. This poses a whole series of complex, interrelated choices ranging from subject matter to "line balance" (i.e., synchronizing the collection, processing, production, and dissemination among methods and means of collection).

The most critical resource allocation choices concern the subjects and geographic areas against which the community should target its energies. Logically this choice would reflect the changing interests of intelligence consumers, weighted according to national importance. Lower-order choices, such as the design and selection of a new technical collection system, would be made in order to meet consumer demands.

Unfortunately, the system does not work this way. Although expressed with varying degrees of forcefulness, almost every previous study of the management problems of the national intelligence community has agreed that the formal mechanism for establishing priorities to guide the community's allocation of resources (i.e., the so-called requirements process) works poorly, if at all. In his 1968 report to the Director of CIA regarding the actions taken in response to the recommendations of the Cunningham Report, Vice Admiral Rufus Taylor put the problem this way:

After a year's work on intelligence requirements, we have come to realize that they are not the driving force behind the flow of information. Rather, the real push comes from the collectors themselves—particularly the operations of large, indiscriminating technical collection systems—who use national intelligence requirements to justify what they want to undertake for other reasons, e.g., military readiness, redundancy, technical continuity and the like.

The Schlesinger and Fitzhugh reports concluded that the focus of the community's efforts is determined by the program managers and operators of the highly complex technical collection systems that dominate the community's budget, rather than by the priorities of the intelli-

gence consumers. Schlesinger called the formal requirements "aggregated wish lists" that could be interpreted as meaning "all things to all people," thereby creating a vacuum which left the individual intelligence entities free to pursue their own interests. The Blue Ribbon Panel noted that no effective mechanism existed for consumers, either national or tactical, to communicate their most important needs.²¹ Requirements, concluded the Panel, "appear to be generated within the intelligence community itself."

In 1960, before major developments in data collection, a joint study group criticized the requirements process and recommended sweeping changes in the system. Six years later, the Cunningham Report described the principal instrument in the requirements process, the Priority National Intelligence Objectives (PNIOs), as a "lamentably defective document which amounts to a ritual justification of every kind of activity anybody believes to be desirable," wryly adding, "We found no evidence that an intelligence failure could be attributed to a lack of requirements."

Poor communication between the producers of intelligence and the consumers continues to be the greatest obstacle to improved efficiency in the use of the community's resources.

6. Resource Allocation

Without judging the appropriateness of the community's subject or geopolitical emphases, a brief description of the way in which resources have been allocated follows.

In FY 1975, more than half the community's effort, about 54 cents of each dollar, was targeted against military subjects such as doctrine, dispositions, force levels, and capabilities. Twelve times more effort went into collecting and processing information of this kind than toward analyzing it. For technical and scientific subjects, the effort was divided in the ratio of six parts collecting and processing to one part analysis. Only about six cents on the dollar was focused on either political or economic subjects. Resource allocation by subject and function is shown in the table below.

NATIONAL INTELLIGENCE PRIORITIES
DISTRIBUTION OF THE FISCAL YEAR 1975 INTELLIGENCE DOLLAR BY SUBJECT¹

Subject area:	Collection	Processing	Production	Total
Military.....	41.4	8.3	4.1	53.8
Scientific and technical.....	11.4	1.8	2.3	15.5
Political.....	2.5	.3	.6	3.4
Economic.....	2.2	.3	.7	3.2
General.....	14.9	8.3	.9	24.1
Total, fiscal year 1975.....	72.4	19.0	8.6	100.0
Total, fiscal year 1974.....	71.8	19.5	8.7	100.0
Total, fiscal year 1976 (requested).....	72.4	19.1	8.5	100.0

¹ Based on the budgets of the Central Intelligence Agency, the State Department's Bureau of Intelligence and Research, and that portion of the Defense Department's budget included within the Consolidated Defense Intelligence Program (CDIP). This does not include mission support costs.

²¹ Two separate consumer priority polls, one undertaken by the staff of the DCI, the other by the DIA, were explained to the Committee. In neither instance was there evidence that the study had produced a significant or lasting impact on management practices.

A second important way in which the existing priorities of the national intelligence community are revealed is through the distribution of spending across the geopolitical spectrum. There is little doubt that the most formidable potential threat to the United States is posed by the Soviet Union, with the second most dangerous potential military antagonist being the People's Republic of China. Most analysts would also hold that the nation's foremost commitment overseas is to the defense of its NATO allies. Vital interests in Asia include the security and pro-Western orientation of Japan and the defense of the Republic of Korea, to which the United States has had long-standing treaty commitments. Instability in the Middle East, to a lesser degree South America, and for the moment in Africa, would seem to argue for special attention to these areas as well.

The attributable portion of the FY 1975 intelligence effort was distributed among different target areas as follows: nearly two-thirds of the resources consumed, 65 cents of each dollar, were directed toward the Soviet Union and U.S. commitments to NATO; 25 cents of each dollar were spent to support U.S. interests in Asia, with most of this targeted against China; the Arab-Israeli confrontation in the Middle East claimed seven cents; Latin America, less than two cents; and the rest of the world, about a penny.

7. Management Efficiency versus Security

In addition to the issues of balance in meeting the demands of both national and tactical consumers, and in the distribution of resources among the collection, processing, production, and dissemination functions in the intelligence sequence, there is also an issue of balance in the flow of information. Here the opposing considerations are security and management efficiency. There is a legitimate need to protect both what is known about a potential adversary's capabilities and the way in which the knowledge was acquired.

The Committee's investigation surfaced considerable sentiment that the community's preoccupation with compartmented security may have reached a point where communications are so restricted that effective analysis and dissemination of intelligence is impaired. The Cunningham Report observed: "Some [intelligence] tasks require piecing together many bits of information to arrive at an answer. Compartmentalization hinders cross-discipline cooperation."

Supporters of the community's existing security arrangements counter that few analysts with a proven "need to know" are denied the clearances necessary to gain access to the information they require. Yet the problem is more subtle than this. Merely allowing the diligent analyst to acquire information is not enough. Kept in ignorance of certain subject areas by the compartmentalization system, it is difficult to determine which particular security barriers to storm in search of that last, missing fact that could unlock the puzzle with which the analyst is grappling.

The Cunningham Report also noted a "real need to make comparisons and tradeoffs between intelligence activities and programs to select the most efficient systems," a need which the Committee believes to be unmet today, despite organizational changes. The manager constrained to a narrow view by the blinders of compartmentalization is hardly in the best position to make such tradeoffs.

D. AGENCIES AND ACTIVITIES OF SPECIAL INTEREST

1. *The Defense Intelligence Agency*

Formally established in August 1961 by Department of Defense Directive 5105.21, the Defense Intelligence Agency (DIA) was envisioned by its civilian proponents as a means of achieving more centralized management control, thereby leading to a "more efficient allocation of critical intelligence resources and the elimination of duplicating facilities and organizations."²³ The Agency was granted full authority for assembling, integrating, and validating all intelligence requirements originating with the Department of Defense, setting the policy and procedures for collecting data, and developing and producing all finished defense intelligence products.

Currently, the Agency is organized into five directorates, each headed by a Deputy Director. The Directorate for Estimates produces all DOD intelligence estimates, including DOD contributions to National Intelligence Estimates (NIEs) for the National Security Council, as well as forecasts in the areas of foreign force structures, weapon systems, deployments, and doctrine. The Deputy Director for Estimates is also responsible for coordinating with CIA, State, and NSA on intelligence estimates, and assisting these agencies with information on military capabilities and strategies.

Intelligence assessments of special interest to military forces in the field are the responsibility of the Directorate for Production. Other directorates specialize in determining foreign technological progress and the performance of foreign weapon systems (the Directorate for Science and Technology); coordinating service requests for intelligence information (the Collection Directorate); and administering the Defense Attache System (the Directorate for Attaches and Human Resources).

The national leaders who established the DIA were alert to the danger that it might evolve into simply another layer in the intelligence bureaucracy, and cautioned against thinking of it as no more than a confederation of service intelligence activities.²⁴ Nonetheless, a decade later executive branch reviews criticized DIA for perpetuating the very faults it had been designed to avoid—duplication and layering.²⁵ By 1970, each service actually had a larger general intelligence arm than it had had before DIA was created. At that time, the Blue Ribbon Defense Panel reported:

Each [military] departmental staff is still engaged in activities clearly assigned to DIA such as intelligence production including the preparation of current intelligence. The Military Departments justify these activities on the basis that DIA does not have the capability to provide intelligence they need. It is interesting that DIA cannot develop a capability to perform its assigned functions, while the Military

²³ Press release accompanying the creation of DIA, cited in the Froehke Report, 7/69.

²⁴ Gilpatric memorandum to Joint Chiefs of Staff, 7/1/69.

²⁵ Fitzhugh Report, Appendix: "National Command and Control Capability and Defense Intelligence," 1970, pp. 33-34; William Beecher, Report of the Defense Panel on Intelligence, 1/76.

Departments, which provide a large proportion of DIA personnel, maintain the required capability and continue to perform the functions.^{25a}

In trying to integrate massive and disparate defense intelligence requirements, DIA had become increasingly bogged down in management problems, notwithstanding a number of internal reorganizations in search of the right mechanisms of coordination. At the root of the DIA's difficulties lie the opposing pulls from Washington-level civilian policymakers, who demand broad insights of a largely political character, and military planners and field commanders, who require narrower and more specific factual data. DIA has never really known which of these groups of consumers comes first. As the Fitzhugh Report stated: "The principal problems of the DIA can be summarized as too many jobs and too many masters."

In retrospect, a strong case can be made that the DIA has never really had a chance. Strongly resisted by the military services, the Agency has been a creature of compromise from the outset. For example, the Director of the DIA was placed in a position of subordination to the Joint Chiefs of Staff (JCS) by designating him to serve as the JCS director for intelligence (replacing the J-2 on the Joint Staff). Drawing again from the Fitzhugh Report, this arrangement put the Director of DIA in the "impossible position" of providing staff assistance on intelligence matters to both the Secretary of Defense and the JCS, whose respective stances on a given issue "often are diverse."

DIA was also reliant on the military for much of its manpower which was initially drawn almost entirely from the intelligence arms of the various services. The argument for manning the new DIA with these personnel was to minimize the disruptive effects of organizational change on the flow of intelligence information. This same case was made for starting the DIA slowly. As a consequence, the Agency never had the impetus which many other newborn government entities have enjoyed and profited from. Dominated and staffed in large part by the professional military, it is not surprising that DIA has come to concentrate on the tactical intelligence demands of the services and their field commands.

Since DIA has always been heavily staffed with professional military officers on short tours, who are dependent on their parent services for future assignments and promotions, the perspective of Agency analyses has often been biased to reflect the views of the services. When evidence is doubtful, the services have incentives to tilt an intelligence appraisal in a direction to support their own budgetary requests to justify existing operations and proposed new ones.²⁵ Intelligence issues in the Vietnam war reflected this problem.

On the budget side of the problem, the Agency has been limited in its ability to control the activities of the services by the lack of follow-

^{25a} Fitzhugh Report, pp. 23, 31-32.

²⁵ Harry Howe Parsons, *The Intelligence Establishment* (Cambridge, Mass., Harvard University Press, 1971), p. 103; Department of Defense, *The Senator Gravel Edition: The Pentagon Papers*, Vol. IV (Boston: Beacon Press, 1971); Patrick J. McGarvey, *CIA: The Myth and the Madness*, pp. 140, 134; *Pentagon Papers*, passim; Chester Cooper, "The C.I.A. and Decision Making," *Foreign Affairs*, January 1972.

up authority over intelligence activities: "Once money to support the approved program is allocated to the services, they may or may not use it for its intended purposes."²⁹ In an effort to remedy this, program management responsibilities over service components of the General Defense Intelligence Program (GDIP) were recently transferred from the Director of DIA to the ASD/I.

The services' concern with autonomy and preservation of wartime capabilities may make the achievement of any appreciable reduction in duplicative effort an impossible goal, at least for general intelligence activities. The problem is not simply one of bureaucratic pettiness; there exist unavoidable trade-offs between tactical and national intelligence interests. The issue of which set of needs should dominate Defense intelligence is a difficult one, with past disagreements on this point having played a major part in the dissatisfaction with DIA that has been expressed by the services, policymakers, and OSD staff.

The jurisdictional dilemma was recognized by Schlesinger in his 1971 report: "If the services retain control over the assets for 'tactical' intelligence, they can probably weaken efforts to improve the efficiency of the community. At the same time there is little question about their need to have access to the output of specified assets in both peace and war." He cited service resistance to the National Security Act of 1947, and to the 1961 DOD Directive establishing the DIA, concluding: "Powerful interests in the military opposed, and continue to oppose, more centralized management of intelligence activities."

A second factor contributing to the dissatisfaction frequently expressed by DIA's customers has been the quality of the Agency's analysis. Most often, this is perceived as a problem of professional competence.

Illustrating the deficiencies in intelligence production as viewed by policymakers, Beecher has quoted former Secretary of Defense Schlesinger: "when you have good analysis, it's more valuable than the facts on a ratio of ten to one. But all decisionmakers get are factual 'snippets.'" Such tidbits, while often interesting in content, are of limited worth if not woven into context. The "analyst" who serves as no more than a conduit for transmitting facts is not providing analysis. Yet, the job of the national intelligence analyst is to sort facts, discarding those which do not appear relevant, and piecing together what remains in a way that yields the broad insights policymakers find most useful.

Besides a thorough understanding of his subject, the competent analyst must possess the qualities of perception, initiative, and imagination. Equally important, the analyst must be kept highly motivated and must be permitted, on occasion, to be wrong. (This is the basis of the argument for maintaining more than one source of key intelligence estimates.)

Critics have often commented harshly on the quality of both civilian and military personnel in DIA.³⁰ There are two facets to the problem of obtaining first-rate analysts: On the military side, capable and ambitious officers have traditionally avoided intelligence assignments,

²⁹ Fitzhugh Report, p. 28.

³⁰ e.g., *Ibid.*, p. 29; "Defense Panel on Intelligence," p. 6; McGarvey, *CIA: The Myth and the Madness, passim*.

deeming such positions not conducive to career advancement. Of the officers who have gone into intelligence, many of the best qualified have tended to serve with their individual service agency rather than joining DIA. DIA's leadership maintains, however, that gains have been made in correcting service biases in the intelligence career field. Since 1974, promotion prospects for officers in the service intelligence agencies have become equal to or better than the service-wide averages. This offers scant consolation for DIA, however, since the promotion rates for attachés and Navy and Air Force officers serving with the Agency have not improved proportionately, and remain less favorable than the service averages. There are, in fact, some indications that promotion prospects for officers at DIA may be deteriorating.³¹

On the civilian side of the personnel problem (about 55 percent of the DIA's 2,700 professional-level employees are civilian), it is frequently argued that a predominance of military officers in middle-management positions limits advancement opportunities within the Agency for civilian professionals. In addition, a significant portion of those "civilian" personnel who have reached management ranks are in fact retired military officers.

Many experts who have studied the DIA's personnel problems have concluded that improvement in the competence of the Agency's civilian analysts is contingent upon a relaxation of the constraints imposed by Civil Service regulations. The 1975 Report of the Defense Panel on Intelligence commissioned by Deputy Secretary of Defense Clements, asserted: "The professionalism of the intelligence production process must be improved substantially," and it strongly recommended exempting DIA's analysts from the Civil Service.

Whether exempting civilian professionals from the Civil Service and increasing their management presence would bring about the changes required to transform the DIA into an effective competitor to the CIA in producing national intelligence estimates remains questionable. The DIA has a problem of image. It is a problem that calls for fundamental reform of its management attitudes and orientation, as well as in its professional staffing. In the absence of the complementary reforms,³² it would seem doubtful that the provision of greater incentives for its civilian analysts, and greater management latitude for the hiring and firing of these analysts by removing Civil Service constraints would in itself suffice to bring about the needed degree of improvement in performance.

Moreover, data on the civilian grade structure of DIA, compared to that of the CIA, suggest that far too much emphasis may be placed on the need to raise the salaries of DIA's civilian analysts. Conventional wisdom holds that the CIA has outperformed the DIA because its superior grade structure permits it to attract and retain more capable analysts. In fact, however, there is no significant difference in the professional grade structure (defined here as GS-9, or equivalent, and above) of the two agencies.

³¹ Memorandum from Vice Admiral DePolx to Secretary of Defense Schlesinger, 3/4/74. Memorandum from Lt. Gen. Graham to Schlesinger, 11/19/74.

³² Such as a new headquarters facility—a request that has been repeatedly denied by the Congress, but is an essential first step if a revitalized DIA within the existing organizational structure is decided upon as the preferred course of action.

About one-third of the upper management positions at DIA are filled by military general officers, a much larger proportion than at the CIA, where fewer military personnel serve.

Criticism of the professional standards of DIA's personnel has not been restricted to the Agency's managers and production analysts. The Defense attachés, who serve under the Agency's direction as the Defense Department's human intelligence (HUMINT) collection arm, have also been a topic of considerable concern. One 1970 study of the Defense Attaché System warned that the representational and protocol responsibilities of attachés were assuming precedence over intelligence functions which should constitute the principal purpose of the attachés.³³ This preoccupation with nonintelligence activities remains strong today.

The qualifications of the officers assigned to attaché duty have been questioned. The chances for promotion have usually been low in DAS and the tendency has been to draw a high proportion of attachés from among officers on their last tours before retirement. Former DIA Director Donald Bennett dismissed 38 attachés outright for incompetence when he took over the Agency in 1969.³⁴

The arguments cited above suggest two basic alternatives for the Defense general intelligence apparatus: either retain the current centralized arrangement under the Defense Intelligence Agency, giving its Director the authority he needs to fulfill his original mandate to manage all of DOD's intelligence collection and production activities, or disband the Agency, returning its resources to the military services from which they were originally requisitioned, leaving the coordination of the tactical military aspects of these activities to the JCS, and forming a staff close to the Secretary of Defense to produce the national intelligence estimates he requires.³⁵

There should either be a major role for DIA, or for the service agencies, but not for both, unless they genuinely serve different functions. Duplication of intelligence analyses can be valuable if it promotes diversity and motivates through competition. This assumes that the separate analysts have different perspectives on the issues. In this sense, competition between CIA analysts and Defense Department analysts for strategic estimates, is very useful. By arguing different points of view in forums in the intelligence community they force disagreements to the surface and expose evaluations to closer scrutiny. DIA now has had little incentive to serve as a CIA-type foil to the services, since DIA has been primarily a military organization.

Specific measures which might improve the performance of DIA within the existing organizational structure include the following:

a. Enhance professional competence.—Exempt DIA from Civil Service regulations in the same manner as CIA and NSA. Open more top-level jobs within DIA to civilian staffers. Increase incentives for the military services to send better qualified officers to DIA. Waive seniority requirements for Defense Attachés. Rotate DIA and CIA strategic analysts through each agency on temporary tours.

³³ Report of the DIA Defense Attaché System Review Committee, 5/30/70, pp. II-1, II-2.

³⁴ Staff summary of Lt. Gen. Donald V. Bennett, USA (ret.) interview, 7/23/75.

³⁵ A nucleus for which already exists in the Office of Net Threat Assessment.

b. Increase the responsiveness of the Agency to the Secretary of Defense and his staff.—Give ASD/I (or the new Deputy Secretary) authority to deal with the substance of intelligence programs as well as the allocation of resources. Have the Director of DIA report directly to the Secretary of Defense, rather than through the JCS, as under the present arrangement. Appoint a civilian as either the Director or Deputy Director and make the Director subject to Senate confirmation.

c. Increase DIA's management authority to match its management responsibility.—Allow DIA to establish more requirements for the service intelligence agencies, and to eliminate intelligence products of the military services which are unnecessarily duplicative.

d. Increase lateral communication between DIA and other components of the defense intelligence apparatus.—To integrate better the work of the operators, analysts, and planners, encourage communication among DIA regional analysts and desk men in CIA, ISA, and other policy staff offices in DOD and State.

2. *The National Security Agency*

The National Security Agency/Central Security Service (NSA/CSS) provides centralized coordination, direction, and control of the Government's Signals Intelligence (SIGINT) and Communications Security (COMSEC) activities.

The SIGINT or foreign intelligence mission of NSA/CSS involves the interception, processing, analysis, and dissemination of information derived from foreign electrical communications and other signals. SIGINT itself is composed of three elements: Communications Intelligence (COMINT), Electronics Intelligence (ELINT), and Telemetry Intelligence (TELINT). COMINT is intelligence information derived from the interception and analysis of foreign communications. ELINT is technical and intelligence information derived from electromagnetic radiations, such as radars. TELINT is technical and intelligence information derived from the interception, processing, and analysis of foreign telemetry. Most SIGINT is collected by personnel of the Service Cryptologic Agencies located around the world. The Director, NSA/Chief, CSS has authority for SIGINT missions.

The COMSEC mission protects United States telecommunications and certain other communications from exploitation by foreign intelligence services and from unauthorized disclosure. COMSEC systems are provided by NSA to 18 Government departments and agencies, including Defense, State, CIA, and FBI. The predominant user, however, is the Department of Defense. COMSEC is a mission separate from SIGINT, yet the dual SIGINT and COMSEC missions of NSA/CSS do have a symbiotic relationship, and enhance the performance of the other.

A specific National Security Council Intelligence Directive (NSCID) defines NSA's functions. It is augmented by Director of Central Intelligence Directives (DCIDs) and internal Department of Defense and NSA regulations.

NSA responds to requests by other members of the intelligence community, such as CIA, DIA, and FBI, to provide "signals" intelligence on topics of interest. An annual list of SIGINT requirements is given to NSA and is intended to provide the NSA Director

and the Secretary of Defense with guidance for the coming year's activities. These requirements are usually stated in terms of general areas of intelligence interest, but are supplemented by "amplifying requirements," which are time-sensitive and are expressed directly to NSA by the requesting agency. NSA exercises discretion in responding to these requirements; it also accepts requests from the executive branch agencies. NSA does not generate its own requirements.

All requirements levied on NSA must be for foreign intelligence. Yet, the precise definition of foreign intelligence is unclear. NSA limits its collection of intelligence to foreign communications and confines its activities to communications links having at least one foreign terminal. Nevertheless, this is based upon an internal regulation and is not supported by law or executive branch directive.

Although NSA limits itself to collecting communications with at least one foreign terminal, it may still pick up communications between two Americans when international communications are involved. Whenever NSA chooses particular circuits or "links" known to carry foreign communications necessary for the production of foreign intelligence, it collects all transmissions that go over those circuits. Given current technology, the only way for NSA to prevent the processing of communications of U.S. citizens would be to control the selection, analysis, or dissemination phases of the process.

Communications intelligence has been an integral element of United States intelligence activities. Foreign communications have been intercepted, analyzed, and decoded by the United States since the Revolutionary War. During the 1930s, elements of the Army and Navy collected and processed foreign intelligence from radio transmissions. Much of their work involved decryption, as well as enciphering United States transmissions. Throughout World War II, their work contributed greatly to the national war effort.

Since President Truman authorized NSA's establishment in 1952 to coordinate United States cryptologic and communications activities, tremendous advances have been made in the technology of communications intelligence. These advances have contributed to an expansion in demands for a wider variety of foreign intelligence and of requirements placed upon NSA/CSS SIGINT personnel and resources. As new priorities arise in the requirements process, greater demands will be placed upon NSA.

It is also necessary to face the problem of integrating intelligence requirements for foreign policy and national security with Constitutional constraints and safeguarding of domestic civil liberties. NSA's intercept programs and possible violation of Fourth Amendment rights are discussed in the section, "National Security Agency Surveillance Affecting Americans," in the Committee's Domestic Intelligence Report.

E. MILITARY COUNTERINTELLIGENCE AND INVESTIGATIVE ACTIVITIES

1. Background

The Department of Defense defines "military counterintelligence and investigative activity" as all investigative activity apart from foreign intelligence-gathering. Although this nomenclature is rela-

tively recent, the military services have always conducted investigations. None of these investigative activities are expressly authorized by statute; rather, they have been justified as necessary to the military mission. On occasion, investigative activity by the military has exceeded measures necessary to protect or support military operations.

In 1917, for example, Colonel Ralph Van Deman of the Army intelligence bureau recruited civilians in the Army Reserve and used volunteer investigators to report on "unpatriotic" conduct. Van Deman's men were soon dispersed throughout the country, infiltrating such organizations as the Industrial Workers of the World, mingling with enemy aliens in major cities, and reporting on all types of dissenters and radicals. Much of this civilian surveillance continued after World War I, particularly in the area of labor unrest. In the 1920s the Army had "War Plans White" to deal with anticipated uprisings of labor and radicals. In 1932 the Chief of Army Intelligence collected information on the "bonus marchers" arriving in Washington, D.C.

Similarly the activities of the Office of Naval Intelligence (ONI) have not always been restricted to military affairs. Traditionally, ONI has provided security for naval contractors, guarded ships, searched crews, detected illegal radio stations, and investigated naval personnel, enemy sympathizers, and civilians whose activities were "inimicable to the interests of the Navy."

Then, in the late 1960s during a period of considerable civil unrest in the United States, the three services—particularly the Army—were called upon to provide extensive information on the political activities of private individuals and organizations throughout the country.³⁶

2. Areas of Investigation

DOD's counterintelligence and investigative activities are conducted for many purposes, both within the United States and abroad.³⁷

a. Violations of the Uniform Code of Military Justice.—The UCMJ is a code of criminal laws which applies to all military personnel of the Department of Defense. The Secretary of each military department is responsible for enforcement of its provisions within his department. Investigations of UCMJ violations take place within the United States and in foreign locations where military personnel are stationed.

b. Security Clearances.—The Department of Defense conducts background investigations to determine whether to award security clearances to its military and civilian personnel or to the personnel of civilian contractors. These investigations are done both in the U.S. and abroad.

³⁶ For a detailed description of this and other improper military investigative activities, see the Select Committee's report entitled "Improper Surveillance of Private Citizens by the Military."

³⁷ Examples include investigations of security leaks, investigations in support of the Secret Service, investigations of theft at the facilities of Government contractors, and investigations—once military forces have been called in—to suppress domestic violence. None of these activities, however, currently represents a significant expenditure of investigative effort.

Military intelligence units also have certain counterintelligence functions to perform which relate to a unit's combat responsibilities.

c. *Counterespionage.*³⁸—Under an agreement with the Federal Bureau of Investigation,³⁹ each of the military departments conducts counterespionage investigations on military and civilian members of their respective military departments, although all such operations are controlled by the FBI. In overseas jurisdictions where military commanders have control over occupying forces, the military departments are given more latitude to conduct counterespionage investigations, but these are coordinated with the Central Intelligence Agency.

Counterespionage investigations may be offensive or defensive in nature. Offensive investigations seek to obtain information on the purposes or activities of a hostile intelligence service. Defensive counterespionage investigations involve the identification of military personnel who are working for agents of a hostile intelligence service. Counterespionage operations are undertaken in both domestic and foreign settings.

d. *Threats to DOD Personnel, Property, and Operations.*—This type of investigation is distinguished from a counterespionage investigation because no hostile intelligence agency is involved. Rather, the "threat" typically arises from civilian groups and individuals whose activities might subvert, disrupt, or endanger the personnel, property, or operations of DOD. While "threat" information is normally obtained from local law enforcement authorities, the military has traditionally reserved the right to conduct its own investigations of such matters both in the U.S. and abroad.

In summary, one should remember that "military counterintelligence and investigative activity" is not a static category. It includes investigations undertaken for any reason apart from foreign intelligence collection. These range from investigations of lost property to investigations of fraud at servicemen's clubs. Moreover, the four general categories cited above expand and contract to meet changing military needs and demands from the Executive.

3. Supervisory Structure

The Secretary of Defense is ultimately responsible for all counterintelligence and investigative activity conducted by the Department of Defense. However, the Secretary has delegated management responsibility for this activity to the Assistant Secretary of Defense (Comptroller).⁴⁰ He, in turn, has delegated this responsibility to the Deputy Assistant Secretary of Defense (Comptroller), who was assigned responsibility for the Defense Investigative Program Office (DIPO).

DIPO apportions counterintelligence and investigative resources within the Department of Defense. The Office has budgetary control of funds allocated for these activities, and provides policy guidance. However, although DIPO stays informed of activities of the investigative agencies, it does not exercise formal operational control over them. In fact, no element at the OSD level exerts centralized opera-

³⁸ The counterespionage investigations of the Department of Defense are described in detail in a classified staff report of the Committee.

³⁹ The Delimitations Agreement of 1949. Each of the military departments has promulgated the agreement as a departmental regulation.

⁴⁰ DOD Directive 5118.8.

tional control over counterintelligence and investigative activities.⁴¹ The one Defense Department agency engaged in such activity, the Defense Investigative Service (DIS), and the three military departments largely retain independent operational control of their own activities.

4. *The Defense Investigative Service (DIS)*

DIS is the only Defense agency established specifically to carry out counterintelligence and investigative activities.⁴² Created in 1972, its chief function is performance of all security clearance investigations for civilian and military members of the Department of Defense as well as for all employees of Defense contractors. DIS also has been assigned responsibility for conducting "such other investigations as the Secretary of Defense may direct," thus making it a special investigative arm of the Secretary.⁴³

DIS performs the special function of operating a computer index known as the Defense Central Index of Investigations (DCII). This is a computerized index which contains not only references to previous security clearance investigations, but also references to virtually every DOD investigation conducted in the past.⁴⁴ According to recent congressional testimony, the DCII now contains references to DOD files on approximately 15 million Americans.⁴⁵ DIS does not maintain the files, but indicates to requesters which DOD counterintelligence and investigative agency holds the file.

DIS has 280 offices across the United States, staffed by 2,620 military and civilian employees. DIS does not have personnel located overseas, but is responsible for security clearance investigations that may require tracking down leads overseas. Normally, an overseas element of one of the services would support DIS in such cases.

5. *The Military Departments*

In the Navy and Air Force, all counterintelligence and investigative activity, in both domestic and foreign contexts, is centralized in one element. In the Army, such activity is dispersed.

a. *Navy*.—All foreign and domestic counterintelligence and other investigative activity in the Navy is carried out by the Naval Investigative Service (NIS). The Director of NIS reports to the Director of Naval Intelligence, who has responsibility for foreign intelligence gathering in the Navy. He, in turn, reports to the Chief of Naval Operations. In 1975, 169 military and 744 civilian personnel⁴⁶ were assigned to NIS.

⁴¹ The Defense Intelligence Agency made an unsuccessful effort to gain control of these activities in the late 1960s.

⁴² The National Security Agency and Defense Intelligence Agency also have small elements with counterintelligence and investigative functions. These elements exist solely to protect the activities of the agencies of which they are a part.

⁴³ DOD Directive 5105.42.

⁴⁴ The DCII is routinely purged of references to files which have been destroyed because of their age, files on deceased subjects, or files which DOD directives have stipulated may not be retained.

⁴⁵ Testimony of David O. Cooke, Deputy Assistant Secretary of Defense (Comptroller). House Subcommittee on Government Operations, 1975 (unpublished).

⁴⁶ NIS agents are all civilian employees.

b. Air Force.—All Air Force investigative activity is carried out by the Air Force Office of Special Investigations (AFOSI). In contrast to NIS, the Director of AFOSI reports to the Air Force Inspector General. In 1975, AFOSI had 1,537 military and 384 civilian personnel assigned to it.

c. Army.—In the Army, criminal investigations are separated from other types of counterintelligence and investigative activity. They are carried out worldwide by the United States Army Criminal Investigation Command, the Director of which reports directly to the Army Chief of Staff.

Remaining counterintelligence and investigative activities are apportioned between the United States Army Intelligence Agency (USAINTA) and the military intelligence units located overseas. USAINTA has responsibility for all activities within the United States and in overseas locations where military intelligence units are not located. Where military intelligence units are part of Army forces stationed overseas (e.g., West Germany and Korea), they ordinarily carry out counterintelligence and investigative activity in their respective locations. Where an investigation proves to be beyond their capacity, USAINTA elements may be called upon.

Both the commanding office of USAINTA and the commanders of military intelligence groups overseas report to the Army Assistant Chief of Staff for Intelligence, who is responsible for the foreign intelligence-gathering activities of the Army. In 1975, the Army had assigned 2,822 military and 1,346 civilian personnel to counterintelligence and other investigative activities.

6. Results of Select Committee Inquiry

The Select Committee carried out an extensive investigation of the counterintelligence and investigative activities of DOD insofar as they have resulted in illegal and unwarranted intrusions into the political affairs of civilians. The results of the investigation are published in detail in the Committee Report entitled "Improper Surveillance of Private Citizens by the Military."

The Committee found that while certain of DOD's past counterintelligence and investigative functions resulted in the collection of information on the political activities of private citizens, DOD has effectively brought its counterintelligence and investigative activities under control since 1971. The Committee found that DOD currently maintains little information on unaffiliated individuals; that which it does maintain arguably falls within the terms of the Department's internal restrictions. Similarly, the Committee found that operations against civilians had been authorized in accordance with departmental directives.

Despite the success of the Department's internal directives to limit intrusions into the civilian community, the Committee nevertheless finds them inadequate protection for the future and recommends that more stringent legislative controls be enacted.

F. CHEMICAL AND BIOLOGICAL ACTIVITIES

The terrible wounds inflicted by chemical weapons, such as chlorine and mustard gas, in World War I spawned international attempts to ban their use in warfare. The 1925 Geneva Convention succeeded

only in banning first use in war of chemical and biological weapons. The United States signed this Convention but Congress failed to ratify it; thus, the United States was not bound by its prohibitions. Nevertheless, there was a widespread belief that the United States would comply with the Convention.

Since the ban applied only to a country's first use of these agents, both the Allied and the Axis powers in World War II researched and stockpiled chemical and biological weapons in order to retaliate against first use by an enemy. Ironically, as the first President publicly to commit the United States to the policy of the Geneva Convention, President Roosevelt announced in June 1943, with the intent of warning Japan against the use of such weapons: "I state categorically that we shall under no circumstances resort to the use of such weapons [poisons or noxious gases] unless they are first used by our enemies." As he spoke, however, he knew the United States had intensified its biological research effort three months earlier with the construction of a facility for drug research at Fort Detrick, Maryland.

The threat of retaliation against a country using such weapons was effective. Although Germany was thought to have a stockpile, it did not touch it, even in the last desperate months of World War II. After the War, the United States program of research and development on such agents continued in order to maintain a weapons capability sufficient to deter first use by hostile powers. The Army's facility at Fort Detrick remained the center of biological weapons research and development.

1. Chemical and Biological Activities^{46a}

Against this background, the Central Intelligence Agency entered into a special agreement with the Army on a project which the CIA codenamed MKNAOMI. The original purpose of MKNAOMI is difficult to determine. Few written records were prepared during its 18-year existence; most of the documents relating to it have been destroyed; and persons with knowledge of its early years have either died or have been unable to recall much about their association with the project. However, it is fair to conclude from the types of weapons developed for the CIA, and from the extreme security associated with MKNAOMI, that the possibility of first use of biological weapons by the CIA was contemplated.

The Army agreed that the Special Operations Division (SOD) at Fort Detrick would assist the CIA in developing, testing, and maintaining biological agents and delivery systems. By this agreement, CIA acquired the knowledge, skill, and facilities of the Army to develop biological weapons suited for CIA use. In 1967, the CIA summarized MKNAOMI objectives:

- a. To provide for a covert support base to meet clandestine operational requirements.
- b. To stockpile severely incapacitating and lethal materials for the specific use of TSD [Technical Services Division].
- c. To maintain in operational readiness special and unique items for the dissemination of biological and chemical materials.

^{46a} See Chapter XVI.

d. To provide for the required surveillance, testing, upgrading, and evaluation of materials and items in order to assure absence of defects and complete predictability of results to be expected under operational conditions."

In reviewing the records and testimony of SOD personnel, it is easy, for the most part, to distinguish SOD's work for the Army from its work for the CIA, even though very few SOD scientists knew of the CIA connection. For example, the CIA personnel who worked with SOD were identified as military officers from the fictitious Staff Support Group, whose interest in SOD was markedly different from the Army's. The CIA was careful to ensure that its moneys were transferred to SOD to cover the cost of CIA projects and the few existing SOD records indicate which projects were to be charged against the funds received from "P-600," the accounting designation for CIA funds.

SOD's work for the Army from 1952 until the early 1960s was primarily to assess the vulnerability of sensitive installations, such as the Pentagon, air bases, and subway systems, to biological sabotage by an enemy. In order to conduct these tests, SOD personnel would develop small, easily disguised devices—such as spray cannisters and spray pens—containing harmless biological agents. SOD personnel would surreptitiously gain access to the installation, leaving the devices to release the biological agent. SOD personnel would then monitor its spread throughout the installation. In this way, SOD could determine how vulnerable the installation was to sabotage of this kind and could advise those charged with security of the installation on counter-measures.

Although the CIA was interested in the kinds of delivery devices which SOD could make for delivery of the biological agents, CIA projects were distinct because they involved the mating of delivery systems to lethal or incapacitating biological agents, instead of harmless agents used in vulnerability tests. The CIA would ask SOD to produce a delivery system and a compatible biological agent—a request not made by the Army until the early 1960s.

SOD developed pills containing several different biological agents which could remain potent for weeks or months, and dart guns and darts coated with biological agents. SOD also developed a special gun for firing darts coated with a chemical that could incapacitate a guard dog in order to allow CIA agents to knock out the guard dog silently, enter an installation, and return the dog to consciousness when leaving. SOD scientists were unable to develop a similar incapacitant for humans.

SOD on occasion physically transferred biological agents in "bulk" form, various delivery devices, and most importantly, delivery devices containing biological agents, to CIA personnel. Although none of the witnesses before the Select Committee could recall any transfer of such materials for actual use by the CIA, evidence available to the Committee indicates that the CIA attempted to use the material. It is fair to conclude that biological agents and delivery devices prepared at Fort Detrick and transferred to the Staff Support Group were carried

"Memorandum from Chief, TSD/Biological Branch to Chief, TSD, "MKNAOMI: Funding, Objectives, and Accomplishments," 10/18/77, p. 1.

by CIA agents in attempted assassinations of foreign leaders. However, the Committee found no evidence that such material was ever in fact used against a person by the CIA.

By the early 1960s, the Army also became interested in the type of work SOD was doing for the CIA. The Army apparently decided that this type of surreptitious delivery device might be useful to Special Forces units in guerrilla warfare. SOD developed special bullets containing poison darts which could be fired, with little noise, from standard military weapons and small portable devices capable of spraying biological agents into the air which would form lethal clouds. Ultimately, the Army stockpiled a quantity of these bullets, but never transferred them to field units.

SOD developed another capability according to existing records which, so far as the Committee could determine, was never tapped by Army or by the CIA. Whereas most SOD work was devoted to biological weapons which would kill one individual noiselessly and with almost no trace of which would kill or incapacitate a small group. SOD did research the possibilities of large-scale covert use of biological weapons. SOD scientists prepared memoranda, which were passed to the CIA, detailing what diseases were common in what areas of the world so that covert use of biological weapons containing these diseases could easily go undetected. SOD researched special delivery devices for these biological agents, but it never mated such delivery devices with biological agents.

In addition to CIA interest in biological weapons for use against humans, it also asked SOD to study use of biological agents against crops and animals. In its 1967 memorandum, the CIA stated:

Three methods and systems for carrying out a covert attack against crops and causing severe crop loss have been developed and evaluated under field conditions. This was accomplished in anticipation of a requirement which was later developed but was subsequently scrubbed just prior to putting into action.

2. Termination

All the biological work ended in 1969. Shortly after taking office, President Nixon ordered the staff of the National Security Council to review the chemical and biological weapons program of the United States. On November 25, 1969, he stated that the United States renounced the use of any form of biological weapons that kill or incapacitate. He further ordered the disposal of existing stocks of bacteriological weapons.

On February 14, 1970, the President clarified the extent of his earlier order and indicated that toxins—chemicals that are not living organisms but are produced by living organisms—were considered biological weapons subject to his previous directive. The Defense Department duly carried out the Presidential directive according to the instructions and supervision of the National Security Council staff. However, a CIA scientist acquired from SOD personnel at Fort Detrick approximately 11 grams of shellfish toxin, a quantity which was approximately one-third of the total world production and which was sufficient to prepare tens of thousands of darts. This toxin, a known danger

if inhaled, swallowed, or injected, was then stored in a little-used laboratory at the CIA where its presence went undetected for five years.

The transfer from SOD to the CIA resulted in a major quantity of the toxin being retained by an agency in a manner which clearly violated the President's order. The evidence to the Committee established that the decision to transfer and to retain the shellfish toxin was not made by, or known to, high-level officials of either the Defense Department or the CIA. The Director of the CIA was told of the possibility of retaining the toxin, but he rejected that course of action. The Committee found that the decision to keep the toxin, in direct and unmistakable contradiction of a widely announced Presidential decision, was made by a few individuals in the CIA and SOD.

Nevertheless, the history of MKNAOMI and the atmosphere surrounding it undoubtedly contributed to the mistaken belief of these individuals that they were not directly affected by the President's decision. The MKNAOMI project itself was contrary to United States policy since 1925 and to Presidential announcement since 1943, for it contemplated a first use of biological weapons by the CIA—albeit in the context of small covert operations. Moreover, because of the sensitive nature of MKNAOMI, these scientists gave their superiors little written record of their work and received little or no written guidance. The National Security Council staff, charged by the President with determining what U.S. policy should be, did not discover MKNAOMI in the course of its study and did not, therefore, consider the possibility that the CIA had biological weapons or biological agents. The CIA employee who claims to have made the decision, on his own, to retain the toxin received no written instructions to destroy them. Kept outside the National Security Council's study, the employee had to rely only on the newspaper account of the President's announcement and on his own interpretation of it.

G. MEETING FUTURE NEEDS IN DEFENSE INTELLIGENCE

The defense intelligence establishment poses two fundamental problems for future national policy. The first is how to improve the quality of intelligence and ensure that intelligence collection and production are responsive to the needs of both the executive and legislative branches; the second is how Congress can exercise responsible oversight of the intelligence agencies. These goals require not only executive-legislative cooperation in control of the intelligence establishment, but also the design of a managerial and consultative system which is conducive to efficiency in routine activities, and adaptive to new priorities.

1. Anticipating New Requirements

It is a truism that generals should not plan for the next war by preparing for the last one; so too the intelligence community should not simply prepare to predict the last crisis. Ideally, allocation of intelligence resources should *precede* crises, not follow them. For example, concentration of a larger proportion of intelligence assets on economic issues should have begun before the 1973 oil embargo and energy crisis, not subsequently. In order to anticipate threats, which is the essential function of peacetime defense intelligence, the agencies

must strengthen their ability to anticipate the proper targets for collection and analysis.

The fundamental task of military intelligence will always be to detect the numbers, characteristics, and locations of enemy weapons, personnel, communications, and intelligence systems. As the world changes, however, the identities of enemies and the relative importance of different security threats change. The allocation of intelligence resources which was appropriate in a bipolar world, where the most likely threats were strategic nuclear war or large-scale conventional military engagements in the third world, is less appropriate in a world where power is becoming more diffused. For example, although the energy crisis (which is increasing the spread of nuclear power reactors and eroding the technical and economic barriers to acquiring nuclear weapons) and the growth of regional power rivalries (which increases incentives to acquire such weapons) are combining to make nuclear proliferation an imminent threat, the Air Force unit responsible for nuclear intelligence still directs virtually all of its assigned technical collection resources against the USSR and China.⁴⁸

In the short range, it is obvious that problems such as nuclear proliferation and international terrorism will be given increasingly high priorities in national intelligence. Since DOD has the vast majority of collection assets, it should be increasingly involved in these problem areas. In doing so, a new balance may have to be struck between the national/peacetime intelligence priorities of the Department of Defense and the intelligence community as a whole, and the tactical/wartime requirements of the military. The critical problem for improving intelligence in the long-range, however, is to identify the mechanisms which are conducive to adaptation, re-evaluation of priorities, and flexible distribution of collection and analysis assets. Feedback from consumers of national intelligence—such policy and research agencies as ISA, DDR&E, State, NSC, ERDA, and ACDA—should be regularized, and DOD should also be responsive to the community-wide committees (such as IRAC, NSCIC, USIB, or IC Staff) which consider the interface between issue urgency and collection capabilities.

2. Effects of New Technology

Technological change produces both new capabilities and new barriers in intelligence collection. Unless the U.S. loses its wide lead in capacity for technological innovation, however, scientific advances are likely to be a net benefit.^{49a}

In the near future, expanded computer capabilities can be expected to improve the integration and availability of processed information by use of a central bank with data, pictures, and reports digitized for quick retrievability according to title or substance. This would offer the efficiency and thoroughness of a full text search, but it also raises the issue of the proper extent of compartmentation.

Improved technology also offers hedges against vulnerability and political sensitivity. Development of unmanned mobile sensors for dangerous peripheral reconnaissance missions can eliminate most of the risks in current collection programs, or the potential for crises

⁴⁸ Air Force briefing for Select Committee staff, July 1975.

^{49a} See the Committee's detailed report on Intelligence and Technology.

and embarrassments which followed the North Korean seizure of the *Pueblo* and downing of the EC-121. Both a reduction in risk and an increase in cost-effectiveness could be possible if improved technology results in substantial manpower reductions.

Technology is interactive. Availability of new techniques for monitoring or verification may provoke enemy countermeasures, and enemy development of new weapons systems can produce the need for new techniques of verification. (Heavy deployment of cruise missiles or development of mobile land-based ICBMs by either the U.S. or U.S.S.R., given current detection capabilities, would create virtually insoluble problems of verification of strategic arms limitation agreements. Development by either side of certain technical innovations, on the other hand, could be undesirable. A breakthrough in ability to detect and fix the location of submarines, for example, would destabilize mutual nuclear deterrence by increasing the vulnerability of the other side's second-strike capability.) The complex dynamics of these interactions require substantial attention to coordinating R&D for intelligence with policy considerations. The expense which goes with technical sophistication also suggests the need for rigorous cost-benefit analysis in intelligence R&D, to judge the relative utility of new capabilities.

3. Restructuring Defense Intelligence Organizations

The pattern of DOD intelligence organization is obviously important for the division of authority and responsibility within the departments, but it also has ramifications for the control and direction of the intelligence community as a whole. Internally, there are divergent interests and needs, particularly between the civilian leadership in OSD and the military leadership in the JCS and unified commands. Externally, there is an imbalance between the responsibility of the DCI to direct the collection and production of national intelligence, and the predominance of DOD in control of actual assets.

Within the defense establishment there has traditionally been a trade-off in the view of many observers, between the peacetime needs of the Secretary of Defense for "national" intelligence on general politico-military developments and trends, and the wartime needs of the professional military for "tactical" intelligence on enemy forces and operations. This distinction may be eroding since central national sensors can have important tactical applications.

Nevertheless, the Secretary of Defense and JCS have different responsibilities, and thus different intelligence priorities. Dissatisfaction with fragmentation and duplication of service intelligence support to the Secretary led to the formation of the Defense Intelligence Agency 15 years ago. The DIA was supposed to integrate military intelligence activities, and to serve the needs of both OSD and the services. There has been widespread criticism of DIA's performance since it was created.

The new Deputy Secretary of Defense position is designed to assert greater control of DOD intelligence from the OSD level. If OSD staff resources for intelligence are increased, and DIA's role is decreased, the trade-off between service needs and the needs of national leadership may be recognized, accepted, and dealt with, in contrast to the earlier attempt to "cure" the problem by combining managerial func-

tions in DIA. There has been a similar potential problem in NSA, although it has provoked far less concern than DIA since NSA must also serve national and tactical needs. In 1961 the JCS attempted to gain control of that agency,⁴⁰ and in recent years some critics at the other extreme have suggested taking NSA out of DOD, since it serves many non-military needs. The entire problem of dealing with the mutual relations of national and tactical intelligence may be clarified as the DCI assumes the additional authority granted to him by the President's Executive Order of February 18, 1976.

While establishment of a Pentagon intelligence czar in the form of the new Deputy Secretary may reduce fragmentation within the department and improve the coherence of military intelligence, it will probably have a major impact on the coordinating role of the DCI. Given that the overwhelming volume of total U.S. intelligence collection and production occurs within DOD, the Deputy Secretary could become, in effect, a second DCI. The definition of the relation between these two officials will be the single most critical factor in top-level organization for management of national intelligence.

4. Requirements for Congressional Oversight

If Congress attempts to exercise more comprehensive and detailed oversight of intelligence agencies, the biggest issue is likely to be what information the executive branch should make available. On defense intelligence there is likely to be less of a problem if Congress concentrates on issues of intelligence process rather than substance. There is, of course, a limit as to how far it is possible to evaluate the former without considering the latter. Therefore, norms will have to be established about what kinds of material (for example, finished intelligence) will be subject to scrutiny by Congress on a routine basis. Provision should also be made to keep basic information on budgets and resource allocation in a clear and available form in the Pentagon, obtainable by the oversight committee on demand. More consistent and thorough documentation of the chain of command could also be required in internal correspondence (thus avoiding the problem of "unattributable" records of controversial decisions turning up in the files, i.e., unsigned directives or cables which cannot clearly be traced to an authoritative source).

If independent ongoing oversight of the substance of defense intelligence is the goal, an oversight committee should have staff expertise in several areas: (1) Political, to weigh the risks and gains of certain programs and targets; (2) Scientific and Technical, to evaluate sensors; (3) Economic, to judge cost-effectiveness; (4) Military, to consider non-national strategic and tactical requirements of DOD intelligence.

⁴⁰ Memorandum from the Chairman of the Joint Chiefs of Staff Lemnitzer to Secretary of Defense McNamara, 8/2/61.

XVI. DISCLOSURE OF BUDGET INFORMATION ON THE INTELLIGENCE COMMUNITY

At the present time the aggregate amount spent for the intelligence activities of the United States Government is classified. The individual budgets for the Central Intelligence Agency, the National Security Agency, and certain other units within the Department of Defense which gather national intelligence are likewise classified.

The budgets for these agencies—which spend billions of dollars annually—are kept not only from the American people but also from most Members of Congress. This secrecy prevents the public and most Members of Congress from knowing how much is spent on national intelligence and from determining whether that amount is consistent with other national needs and priorities. It prevents the public and most Members of Congress from knowing how much is spent by each of the national intelligence agencies and from determining whether that allocation among agencies is appropriate. Because funds for these agencies are concealed in the budgets of other agencies, the public and most Members of Congress cannot be certain that funds in the open appropriations are used for the purposes for which they were appropriated. No item in the overall federal budget is above suspicion as a hiding place for intelligence agency funds.¹ Finally, and most seriously, the present system of secrecy is inconsistent with the constitutional provision which states:

No Money shall be drawn from the Treasury but in Consequence of Appropriations made by Law; and a regular Statement and Account of the Receipts and Expenditures of all public Money shall be published from time to time.²

¹ During the recent debate in the House of Representatives on the publication of the CIA's budget Congressman Koch described an encounter with DCI Helms, in which Congressman Koch asked about the size of the CIA budget and the number of CIA employees, questions that DCI Helms told Congressman Koch "we don't answer." As Congressman Koch described it, he then asked Mr. Helms "Are you telling me that I, a Member of Congress, do not have the right to know what the budget is, so that when I vote, I do not know what I am voting on?" DCI Helms said, "Yes . . . The item is placed in some other larger item, and you do not know." Congressman Koch then asked, "Do you mean that it might be included under Social Security?", to which DCI Helms replied, "We have not used that one yet, but that is not a bad idea." Cong. Rec. H9359, daily ed., 10/1/75, remarks of Rep. Koch.)

² U.S. Const., Art. I, Sec. 9, Cl. 7. For a fuller discussion of the constitutional and policy issues involved, see "The CIA's Secret Funding and the Constitution," 84 *Yale Law Journal* 608 (1975), "Fiscal Oversight of the Central Intelligence Agency: Can Accountability and Confidentiality Coexist?" 7 *New York University Journal of International Law and Politics* 493 (1974), and "Cloak and Ledger: Is CIA Funding Constitutional?" 2 *Hastings Constitutional Law Quarterly* 717 (1976).

A. THE PRESENT BUDGETARY PROCESS FOR INTELLIGENCE COMMUNITY AGENCIES AND ITS CONSEQUENCES

At present, the Director of Central Intelligence submits to the President recommendations for a consolidated national intelligence program budget. The consolidated national intelligence budget, as well as the budget requests from the various agencies within the intelligence community, are reviewed by the Office of Management and Budget (OMB) in the "same detail that [OMB] reviews the budget requests of any other executive branch agency."³ As former OMB Director Roy Ash described it:

The specific amounts of the CIA's approved appropriations request and the identification of the appropriation estimates in the President's annual Budget, within which these amounts are included, are formally provided by the Director of OMB to the chairmen of the Senate and House Appropriations Committees.⁴

In the past, special subcommittees of the House and Senate Appropriations Committees have considered the CIA budget in closed session; the chairman of the House Appropriations Committee noted that his subcommittee "tried and tried and tried to hold the secrecy of these matters as closely as we could."⁵

These practices have been changing. The entire House Defense Appropriation Subcommittee now scrutinizes the CIA budget. In September of 1975 the Chairman of the House Appropriations Committee invited all the Members of the House of Representatives to review the executive session hearings of the Defense Appropriations Subcommittee on the CIA's budget, although Members had to agree not to remove any documents from the room, not to take notes, and not to reveal the classified information to "unauthorized persons." While the Chairman invited this review by the Members, the full House Appropriations Committee voted not to receive figures on the CIA's budget from the Defense Appropriations Subcommittee.

Neither the Senate Appropriations Committee as a whole nor the Senate as a whole is informed, even in secret session, of the budget figures for the CIA, NSA or certain other intelligence units.

Once the subcommittees of the Appropriations Committee, agree upon the level of funding for the intelligence agencies, these funds are concealed in appropriation requests for other agencies on which the full Appropriations Committees and Senate and House of Representatives vote.

After congressional approval of these appropriations, the chairmen of the Senate and House Appropriations Committees notify the Office of Management and Budget of the size and true location of intelligence agency funds. Funds for the CIA are then transferred

³ Letter from Roy Ash to Senator Proxmire, 4/29/74, quoted in Cong. Rec. S9604, daily ed., 6/4/74, remarks of Sen. Proxmire. It might be argued that the intelligence budgets should be reviewed in even greater detail by OMB as neither the Congress as a whole nor the public can presently participate in the process of reviewing and debating the budget requests in this area.

⁴ Ash letter, 4/29/74.

⁵ Cong. Rec. H9803, daily ed., 10/1/75, remarks of Rep. Mahon. Until 1974, even the names of members of these special subcommittees were withheld from the public.

to the CIA from these appropriations.⁶ Former OMB Director Ash noted:

The transfer of funds to CIA . . . is accomplished by the issuance of Treasury documents routinely used for the transfer of funds from one government agency to another. The amount and timing of these transfers, . . . are approved by OMB.⁷

This whole process treats the CIA and other intelligence agencies in a manner radically different from other highly sensitive agencies of the United States Government, such as the Atomic Energy Commission and the Department of Defense. While intelligence agency budgets may require somewhat different handling, it is important that any special approach reflect real needs justifying departure from the careful processes which Congress has developed over the years for maintaining its power over the purse.

B. THE CONSTITUTIONAL REQUIREMENT

The present budgetary process apparently violates Article 1, Section 9, Clause 7 of the Constitution, which reads:

No Money shall be drawn from the Treasury, but in Consequence of Appropriations, made by Law; and a regular Statement and Account of the Receipts and Expenditures of all public Money shall be published from time to time.

This constitutional provision was intended to insure that Congress would control the governmental purse and that the public would be informed of how Congress and the Executive spend public funds.⁸

In keeping with this constitutional mandate, Congress enacted 31 U.S.C. 66b(a), which provides that:

the Secretary of the Treasury shall prepare such reports for the information of the President, the Congress, and the public, as will present the results of the financial operations of the Government.

⁶ This is done pursuant to 50 U.S.C. 403f which authorizes the CIA to transfer to and receive from other government agencies funds as approved by the OMB.

⁷ Ash letter, 4/29/74. Under established procedures, funds approved by OMB for transfer to the CIA are limited to the amounts which the chairmen of the Senate and House Appropriations Committees specified to OMB.

⁸ See D. Robertson, *Debates and Other Proceedings of the Convention of Virginia, 1788* (Richmond, 1805), p. 326. The Chancellor of New York asked if the public were more anxious about any thing under heaven than the expenditure of their money? 2 J. Elliot, *Debates in the Several States' Conventions on the Adoption of the Federal Constitution*, (Philadelphia: J. B. Lippencott, 1836), p. 347.

The clause was implemented during the first Congress. The act creating the Treasury Department required the Treasurer to annually present each House of Congress with "fair and accurate copies of all accounts" and a "true and perfect account of the state of the Treasury." Act of Sept. 2, 1789, Chapter 12, Section I, I Statute 65.

This Act was replaced by 31 U.S.C. 1029, which provides, "It shall be the duty of the Secretary of the Treasury annually to lay before Congress . . . an accurate, combined statement of the receipts and expenditures during the last preceding fiscal year of all public monies." The receipts, wherever practicable, were to be divided by ports, districts, and states, and the expenditures by each separate head of appropriation.

Fulfilling its charge, the Treasury Department publishes a *Combined Statement of Receipts, Expenditures, and Balances of the United States Government*, which

is recognized as the official publication of the details of receipt and outlay data with which all other reports containing similar data must be in agreement. In addition to serving the needs of Congress, [the report is used by] the general public in its continuing review of the operations of Government. [Emphasis added.]⁹

The *Combined Statement*, however, contains no entry for the Central Intelligence Agency, the National Security Agency or certain other intelligence units within the Department of Defense. While the figure for total funds received and expended by the United States Government is accurate, some funds listed as expended by particular agencies are, in fact, merely transferred from them to the Central Intelligence Agency.

William Colby, former Director of the CIA, has argued that the present practice is constitutional, maintaining that the Constitution permits concealment of funds for agencies such as the CIA. Not only does this position ignore the plain text of the Clause, but it is not supported by the debates, either at the Constitutional Convention or in the ratifying conventions in the various States.

Mr. Colby's argument relies chiefly on the fact that when the Statement and Account Clause was introduced it provided for annual publication of the account, but it was subsequently amended to allow congressional discretion over timing.¹⁰

The amendment was intended, however, not to permit concealment of expenditures from the full Congress and the American people, but rather to insure that the information would be made available in a fashion permitting its thorough comprehension.¹¹ Neither proponents nor opponents of the amendment argued against the assertion

⁹ U.S. Dep't of Treasury, *Combined Statement of Receipts, Expenditures and Balance of the United States Government* (1973), p. 1.

¹⁰ William E. Colby testimony, House Select Committee on Intelligence Hearings, 8/4/75, p. 120. Mr. Colby argued as follows:

"The so-called 'Statement and Account' clause . . . was not part of the initial draft [of the Constitution]. The language first suggested by George Mason would have required an annual account of public expenditures. James Madison, however, argued for making a change to require reporting 'from time to time.' Madison explained that the intent of his amendment was to 'leave enough to the discretion of the Legislature.' Patrick Henry opposed the Madison language because it made concealment possible. But when the debate was over, it was the Madison view that prevailed."

Mr. Colby also argued that the provision allowing Congress to keep their proceedings secret demonstrated the intent of the Framers to provide for concealment. That provision, unlike the Statement and Account Clause explicitly provides for secrecy; moreover, the Statement and Account Clause guarantees an accounting for all public money. For a fuller treatment of this argument, see "The CIA's Secret Funding and the Constitution," *Yale L.J.* 608 (1975).

It could be argued that the constitutional requirement is not violated as the *Combined Statement* provides an accurate total for receipts and expenditures. Under this theory all government funds could be appropriated to one government agency and secretly transferred to the other agencies. As long as the total appropriated and expended were published, the constitutional requirement would be fulfilled.

¹¹ 2 M. Farrand, *Records of the Federal Convention of 1787* New Haven: Yale University Press, 1966, pp. 618-19.

that the people had a "right to know" how their funds were being spent.¹²

It should also be noted that the proponents of congressional discretion did not argue that secrecy was needed. Rather they contended that leaving the interval of publication to be fixed by Congress would result in fuller disclosure, since no agency would be forced to publish an incomplete report to meet an inflexible and unrealistic deadline.¹³ A fixed schedule would result in statements that would be "incomplete"¹⁴ or "too general to be satisfactory."¹⁵ The proponents of the amendment ridiculed the possibility that granting Congress discretion would mean that information would be concealed forever; Congress would publish the reports at regular, frequent intervals.¹⁶

It has been implied that the constitutional requirement has been met, at least in the House of Representatives, in that all Members can examine the Defense Appropriations Subcommittee's executive session hearings on the CIA budget.¹⁷ As one Member of the House noted:

Secrecy in Government is distasteful to a free society, but preservation of our free society demands that we maintain a prudent cloak over vital intelligence operations, so long as the Representatives of the people have the right to examine what is covered—as they do in this situation.¹⁸

Knowledge on the part of *all* of Congress, would satisfy part of the constitutional requirement. As Justice Story noted, one of the purposes of the constitutional requirements is:

to secure regularity, punctuality and fidelity in the disbursements of the public money . . . it is highly proper, that Congress should possess the power to decide how and when any money should be applied for these purposes. If it were otherwise, the executive would possess an unbounded power over the public purse of the nation. . . . The power to control and direct the appropriations constitutes a most useful and salutary check upon profusion and extravagance, as well as upon corrupt influence and public speculation. . . . It is wise to interpose in a republic, every restraint, by which the public treasure, the common fund of all, should be applied with unshrinking honesty to such objects as legitimately belong to the common defense and the general welfare.¹⁹

But even if all of Congress had the information now held by the subcommittees of the Appropriations Committees, the Constitution would still be violated. The Constitution requires that the *public* know how its funds are being spent. The Constitution requires that the statement and account be made public "from time to time."²⁰ This re-

¹² D. Robertson, p. 376. See generally 3 M. Farrand, pp. 140-150.

¹³ 2 M. Farrand, pp. 318-319.

¹⁴ *Ibid.*, p. 318.

¹⁵ *Ibid.*

¹⁶ See D. Robertson, p. 326.

¹⁷ As was noted above at p. 368 this is not the case in the Senate.

¹⁸ Cong. Rec., H9860, daily ed., 10/1/73, remarks of Rep. Robinson.

¹⁹ 2 J. Story, *Commentaries on the Constitution of the United States*, Sec. 1848, pp. 222-228 (5th ed., 1891).

²⁰ Article I, Section 9, Clause 7 provides for publication in contrast to Article 2, Section 3, which provides that the President "shall from time to time give to the Congress Information on the State of the Union."

quirement was imposed to make congressional responsibility "more perfect"²¹ by allowing the people to check Congress and the executive through the publication of information on what "money is expended, for what purposes, and by what authority."²² As Chancellor Livingston pointed out:

You will give up to your state legislature everything dear and valuable; but you will give no power to Congress, because it may be abused; you will give them no revenue, because the public treasures may be squandered. But do you not see here a capital check? Congress are to publish, from time to time, an account of their receipts and expenditures. These may be compared together; and if the former, year after year, exceed the latter, the corruption will be detected, and the people may use the constitutional mode of redress.²³

The debates and later commentary indicate that the constitutional requirement was designed to allow citizens to chart the course of policy through an examination of governmental expenditures—to determine, for example, whether too much money is spent on defense and too little on education, or whether funds spent on bombers should be allocated to submarines. Publication of this information would also enable the people, with Congress, to determine whether expenditures by the executive conform to the intent of the appropriation. Publication of appropriations and expenditures would also provide an opportunity for the people to ascertain if both appropriations and expenditures were for constitutional purposes.²⁴

It is, however, unclear how much information on appropriations and expenditures is required by the Constitution to be published. No one at the Constitutional Convention disagreed with the assertion that it would be impossible to account for "every minute shilling." Even in the present disclosures of appropriations and expenditures of nonsensitive governmental agencies, there is a limit to the amount of detail which can be published.²⁵

The Supreme Court in *United States v. Robel*,^{26a} suggested a standard which might be used to fix the constitutional requirement particularly when claims that publication of the budget would damage national security are raised against the Government's duty to its citizens to publish from time to time a regular statement and account of re-

²¹ 2 J. Story, Sec. 1848, pp. 222-223.

²² *Ibid.*

²³ 2 J. Elliot, p. 845.

²⁴ *Re David Ramsey*, one of the early commentators on the Constitution wrote

If Congress applied any funds for purposes other than those set forth in the Constitution, they would have exceeded their powers. The Clause provides information so that "[t]he people of the United States who pay, are to be judges how far their money is properly applied."

"An address to the Freemen of South Carolina on the subject of the Federal Constitution," in Pamphlets on the Constitution of the United States, p. 374 (P. Ford, ed., 1888). See also *Flast v. Cohen*, 392 U.S. 83 (1968).

²⁵ Of course, a good deal more information, although not published, is available under the Freedom of Information Act.

^{26a} 380 U.S. 253 (1967).

ceipts and expenditures of all public money. The Court held that "when legitimate concerns are expressed in a statute which imposes a substantial burden on First Amendment activities, Congress must achieve its goal by means which have the least drastic impact on the continued vitality of First Amendment freedoms."²⁶

Under this test the constitutionality of a level of disclosure of information on expenditures depends on whether there is another system of greater disclosure which, without endangering national security, would have a "less drastic" impact on the public's right to know how its funds are being spent. It is clear, however, that the present secrecy surrounding the appropriations and expenditures for intelligence—particularly the inflation of unspecified appropriations in which funds for intelligence are concealed—vitiates the constitutional guarantee.²⁷ Under the present system neither the public nor the Congress as a whole knows how much is being spent on national intelligence or by each intelligence agency. In addition, both Congress as a whole and the public are "deceived", as one Senator put it,²⁸ about the "true" size of other agency budgets. As certain unspecified general appropriations contain funds which are secretly transferred to the CIA, it is impossible for most Members of Congress or the public to know the exact amount of money which actually is destined for any government agency.²⁹ Congress is thus unable to set priorities through the allocation of funds,³⁰ or to determine if expenditures by the executive conform to congressional intent and are being spent wisely and well. Members of the public cannot determine with any confidence whether they agree with Congress' allocation of resources and cannot monitor expenditures by the executive branch.

²⁶ 389 U.S. 268, 268. While the public's right to information on governmental expenditures has not been accorded the "preeminent" status of the First Amendment, the test is an appropriate place to begin an analysis.

²⁷ As Justice Black wrote, "The guarantee of military and diplomatic secrets at the expense of informed representative government provides no real security for our republic." *New York Times Co. v. United States*, 403 U.S. 713 at 719 (1971). In the same case, Justice Stewart wrote, "In the absence of the governmental checks and balances present in other areas of our national life, the only effective restraint upon executive policy and power in the area of national defense and international affairs may be in an enlightened citizenry." *Id.* at 728. Justice Stewart's remarks apply equally well to the exercise of power by the Congress.

²⁸ Cong. Rec. S9602, daily ed., 6/4/74, remarks of Sen. Proxmire.

²⁹ Cong. Rec., H9361, daily ed., 10/1/75, remarks of Rep. Evans. As Congressman Evans recently noted, the secrecy surrounding these funds for the intelligence community is infectious: "When we are tucking it away in another pocket in the budget, we are also making a secret of something else that should not be a secret."

³⁰ See e.g., Cong. Rec., H9372, daily ed., 10/1/75, remarks of Rep. Leggett. Congressman Leggett noted, "How can we 'oversee' in any fashion if we have no knowledge of the Agency's command on our resources? How can we set budgetary priorities in a meaningful fashion, if we have no basis for comparing intelligence with unemployment, health, or other competing program areas?"

C. ALTERNATIVES TO CONCEALING INTELLIGENCE BUDGETS FROM CONGRESS AND THE PUBLIC

Within certain limits, Congress has the power to determine how information about the receipts and expenditures of public moneys is made available to the public.³¹

Congress could choose to publish CIA or NSA budgets and expenditures, for example, in detail equal to those of nonsensitive agencies. This approach, however, might threaten the security of intelligence operations or agents. Congress has available another model for budget disclosure to protect the security of certain activities.

Since 1793, certain agencies, such as the AEC, the FBI, and the Department of State have been appropriated funds specifically for "confidential purposes," which for security reasons, are exempt from normal accounting procedures.³² In each instance, however, Congress appropriates funds to the agency directly and publicly specifies the small percentage of the appropriation which is for "confidential purposes" and thus exempt from normal accounting procedures. Drawing on this practice, Congress obviously could publish detailed budgets for the intelligence agencies while providing a lump sum to each for "confidential purposes."

Congress could also devise other models. Congress could publish only the total appropriated to each intelligence agency.³³ As the Special Senate Committee To Study Questions Related to Secret and Confidential Documents³⁴ suggested in 1978, the publication

of such funds should provide members with the minimal information they should have about our intelligence operations. Such information would also end the practice of inflating certain budget figures for use to hide intelligence costs and would insure that all Members would know the true cost of each budget item they must vote upon.

³¹ *Cincinnati Soap Co. v. United States*, 301 U.S. 308 (1933). In fixing the level of detail revealed, however, a congressional decision cannot override a constitutional requirement such as that of Article I, Section 9, Clause 7, particularly as one purpose of that requirement was to serve as a check on Congress.

³² The first such statute authorized special procedures for sums relating to foreign "intercourse or treaty." By the Act of February 9, 1793, Congress provided: "that in all cases, where any sum or sums of money have issued, or shall hereafter issue, from the treasury, for the purposes of intercourse or treaty, the President shall be, and he hereby is authorized to cause the same to be duly settled annually with the accounting officers of the Treasury in the manner following, that is to say; by causing the same to be accounted for, specifically in all instances wherein the expenditures thereof may, in his judgment be made public; and by making a certificate or certificates, or causing the Secretary of State to make a certificate or certificates of the amount of such expenditures as he may think it advisable not to specify; and every such certificate shall be deemed a sufficient voucher for the sum or sums therein expressed to have been expended." [Act of Feb. 9, 1793, ch. 4, sec. 2, 1 Stat. 300, codified as 81 U.S.C. 107 (1970).]

³³ When the AEC was first established only a one line entry in the weapons account was included in the 1947 budget, p. 882.

³⁴ S. Res. 93-466, 93rd Cong., 1st Sess., 10/12/78, p. 16.

The Special Committee recommended that the Appropriations Committee itemize the Defense Department appropriations bill in order that the "total sums proposed to be appropriated for intelligence activities by each of the following agencies: Central Intelligence Agency, Defense Intelligence Agency, National Security Agency, National Reconnaissance Office, and any separate intelligence units within the Army, Navy, and Air Force" could be revealed.³⁵

Finally, the Congress could decide that only the total budget figure for national intelligence be published. This would be the aggregate of funds provided to CIA, NSA, DIA, and the national intelligence components in the Departments of Defense, State, and Treasury. Although there may be problems defining what constitutes "national intelligence," the Director of Central Intelligence already prepares a national intelligence budget. The Director could, with the appropriate congressional committees determine what agencies or departments would be included.³⁶

The secrecy presently surrounding intelligence expenditures vitiates the constitutional guarantee. Even publishing one figure—the total appropriations and expenses for national intelligence—would have a salutary effect. It would eliminate the inflation of figures presently in the Budget and in the Combined Statement resulting from the concealment of intelligence agency funds in other agency appropriations and expenditures. Congress would be able to establish its priorities by placing the amount appropriated for national intelligence activities against other claims on the public purse; the public could make its own independent judgment about priorities.³⁷

As Senator Proxmire noted, publication of the aggregate budget for national intelligence might also have the effect of deterring potential adversaries by showing that the United States Government continues to spend sizeable amounts on intelligence.³⁸ As former DCI and Secretary of Defense Schlesinger noted, publication of this figure might also

³⁵ The Committee specifically did not request that any line items be revealed, although they did recommend the publication of the total number of personnel employed by each agency.

³⁶ The Senate Select Committee has proposed an oversight committee which would have jurisdiction over authorization for national intelligence activities of the United States Government, S. 93-2893.

³⁷ Former Director Colby has argued that publication of the CIA budget would not aid the public in any way. As he put it, "Knowledge of the Agency budget would not enable the public to make a judgment on the appropriateness of the amount without the knowledge of the product and the ways it is obtained." (William Colby testimony, House Select Committee on Intelligence, 8/4/75, p. 123.)

³⁸ Cong. Rec. S9603, daily ed., 6/4/74. Remarks of Senator Proxmire "However, as Senator Pastore noted, if the public figure declined "then the Russians and the Chinese Communists know that we are doing less, and that might let them become more audacious." *Id.* at S9605.

decrease speculation about the budget and focus the debate on intelligence on more significant issues.³⁹

Finally, the disclosure of any figures on intelligence expenditures might well increase the effectiveness of oversight of the intelligence agencies by both individual members of Congress and by the appropriately charged congressional committees. Members of the House might be encouraged to inspect executive session hearings on intelligence agency budgets; ⁴⁰ members of the oversight committees of both houses might be spurred to review the proposed budgets more closely, in anticipation of a possible debate on the figures.⁴¹

D. THE EFFECT UPON NATIONAL SECURITY OF VARYING LEVELS OF BUDGET DISCLOSURE

Even given the constitutional requirement, any disclosure of budgetary information on agencies in the Intelligence Community has been strongly resisted. In responding to a proposal for the publication of the total sum budgeted for the national intelligence community, Senator Stennis noted that:

[I]f it becomes law and is carried out, [it] would, as its practical effect, virtually destroy 80 to 90 percent of the effectiveness of much of our most important work in the field of intelligence.⁴²

And Congressman Burlison told the House that if an amendment which provided for publication of the total figure budgeted for the CIA were adopted, "[t] will totally paralyze the intelligence community."⁴³

An examination of the effect on national security of publication of any data on the intelligence community budgets is difficult, in part because the examination itself must not be allowed to jeopardize the national security. Given the constitutional guarantee, however, the burden of proof must fall on those who would deny this information to

³⁹ During testimony before the Senate Select Committee, Mr. Schlesinger was asked whether there was a good reason for actually publishing a budget figure. He replied: "Only in that the public debate at the present time covers so wide a range that if you had an official number, the debate would tend to die down and focus on something more significant than whether we're spending \$11 billion on intelligence." (James Schlesinger testimony, 2/2/76, p. 54.)

Mr. Schlesinger was later asked whether he thought there was any chance of convincing the American people or the enemy of the truthfulness of any figure that is published, to which Mr. Schlesinger replied: "I do not believe that you could persuade the Soviets that that is a truthful figure, but I am not sure that that is our objective. Whether or not you could persuade the American public, I think there is a large segment of the American public that would be persuaded. . . ." (Schlesinger, 2/2/76, p. 56.)

⁴⁰ See e.g., Cong. Rec., H9861, daily ed., 10/1/75, remarks of Rep. Obey.

⁴¹ See e.g., Cong. Rec., S9603, daily ed., 6/4/74, remarks of Sen. Proxmire.

⁴² Cong. Rec. S9610-11, daily ed., 6/4/74, remarks of Sen. Stennis.

⁴³ Cong. Rec. H9860, daily ed., 10/1/75, remarks of Rep. Burlison.

the public. The possible effects on the national security of certain levels of budget disclosure are examined below.⁴⁴

1. *The Effect on National Security of Publication of the National Intelligence Community Budget*

Many individuals familiar with the intelligence community agree that publication of a gross figure for national intelligence would not, in itself, damage the national security.

During his confirmation hearings as Director of Central Intelligence, James Schlesinger, former Secretary of Defense and past head of the OMB, told Senator Harry F. Byrd, Jr., in regard to the publication of the gross figure for national intelligence: "I think that the security concerns are minimal. The component figures, I would be more concerned about but for the gross national intelligence program figures, I think we could live with that on a security basis, yes."⁴⁵

Former DCI Helms told the Senate Select Committee that because it was so large, publication of a single figure for national intelligence might be "satisfactory."⁴⁶

While it has been suggested that the publication of even a total for the national intelligence budget would aid our enemies,⁴⁷ Mr. Schlesinger told the Senate Select Committee that our enemies "already know in the first place and it's broadly published. All that you would have is a confirmed official figure for information. That is

⁴⁴ There are many possible variants of budget disclosure running from the full disclosure policy governing such government agencies as the Department of Agriculture, through the budget disclosure utilized by the FBI and AEC which provides for a specific appropriation of funds for "confidential" purposes which are exempted from normal accounting requirements, to the possible disclosure of an aggregate figure for each national intelligence agency or for national intelligence as a whole. The Committee has not attempted to analyze the constitutional implications and effect on national security of each, but has focused on the disclosure of the global sum for national intelligence and the aggregate budgets of each intelligence agency.

⁴⁵ Quoted in Cong. Rec., S9603, daily ed., 6/4/74, remarks of Sen. Proxmire.

⁴⁶ Richard Helms testimony, 1/30/76, pp. 36, 37. Because the figure is so large, the introduction of expensive collection systems would not result in a "conspicuous bump" in the budget which would alert hostile powers to new activities by the United States. For a fuller discussion of this argument and its relationship to the publication of the CIA's aggregate budget, see pp. 378-381.

John Clarke, a former Comptroller of the CIA and an advisor to DCI Colby, was asked about the effects of publication of the total national intelligence budget and specifically whether publication of the figure would disclose the existence of, or the start of, a high-cost technical collection system. Mr. Clarke responded, "I have not run the studies on this, but I would be very hard pressed to find a case that I could support. The budget figures don't reflect that. They are down. Historically, at least they have been down inside of a larger figure and it doesn't really pop out in a big way. And it can be explained away." (John Clarke testimony, 2/5/76, p. 47.)

⁴⁷ See e.g. p. 376.

more or less in the public domain anyhow without public confirmation, without official confirmation."⁴⁸

Mr. Schlesinger described for the Select Committee the impact of publishing the total national intelligence budget:

I am not so concerned about that from the security aspect as some people are. I'm not sure I recommend it, but I'm not so concerned about it from the security aspect.

It could do some good in that there are some inflated notions around about how much the United States Government is actually spending on intelligence, and if you had an official statement, I think that would put the total amount of expenditures in better context for the public.^{48a}

2. The Effect on National Security of Disclosure of the Total Appropriated to or Expended by Each National Intelligence Agency

Publication of the total of the CIA's budget or of the other agencies' budgets has also been opposed. In a Freedom of Information Act suit, DCI Colby argued against publication of the Agency's budget total, as follows:

Publication of either the CIA budget or the expenditures made by CIA for any given year would show the amounts planned to be expended or in fact expended for objects of a confidential, extraordinary or emergency nature. This information would be of considerable value to a potentially hostile foreign government. For example, if the total expenditures made by the Agency for any particular year were publicized, these disclosures, when taken with other information publicly available . . . would enable such governments to refine their estimates of the activities of a major component of the United States intelligence community, including specifically the personnel strength, technological capabilities, clandestine operational activities, and the extent of the United States Government intelligence analysis and dissemination machinery. . . . The subsequent publication of similar data for other fiscal years . . . would enable a potentially hostile power to refine its estimates of trends in the United States Government intelligence efforts.

He continued:

The business of intelligence is to a large extent a painstaking collection of data and the formation of conclusions utilizing a multitude of bits and pieces of information. The revelation of one such piece, which might not appear to be of significance to anyone not familiar with the process of intelligence analy-

⁴⁸ Schlesinger, 2/2/76, p. 52. Mr. Schlesinger noted that, as the Intelligence Community has "no constituency," it tends to be "blamed for one thing or another," and "if you had an openly published figure . . . there would be pressure within the Congress at budget mark-up time to take a 15 percent or 20 percent whack at it just for good measure and . . . there is no way of having a public debate about the merits of intelligence." *Id.* at 51-52. Mr. Schlesinger's argument implies that Congress as a whole should not be given information because it should not be allowed to exercise its control over the purse.

sis (and which, therefore, might not arguably be said to be damaging to the national security) would, when combined with other similar data, make available . . . information of great use and which would result in significant damage to the national security of the United States.

He provided the following example of the impact on the nation's security of publication of the CIA's budget:

If it were learned that CIA expenditures have increased significantly in any one given year, but that there has been no increase in Agency personnel (apparent from traffic, cars in the parking lots, etc.) it would be possible to make some reasonable estimates and conclusions to the effect that, for example, CIA had developed a costly intelligence collection system which is technological rather than manpower intensive; and that such system is operational. Knowledge readily available at the time about reconnaissance aircraft photography, and other technology, can result in a more accurate analysis about a new collection system which would enable a potentially hostile power to take steps to counter its effectiveness . . . the development of the U-2 aircraft as an effective collection device would not have been possible if the CIA budget had been a matter of public knowledge. Our budget increased significantly during the development phase of that aircraft. That fact, if public, would have attracted attention. . . . If it had been supplemented by knowledge (available perhaps from technical magazines, industry rumor, or advanced espionage techniques) that funds were being committed to a major aircraft manufacturer and to a manufacturer of sophisticated mapping cameras, the correct conclusion would have been simple to draw. The U.S. manufacturers in question . . . would have become high priority intelligence targets. . . . And I'm sure that the Soviets would have taken steps earlier to acquire a capability to destroy very-high-altitude aircraft. They did indeed take these steps, with eventual success, but only sometime after the aircraft began operating over their territory—that is, once they had knowledge of a U.S. intelligence project.⁴⁹

A close examination of Mr. Colby's statement raises a number of questions as to the effect of publication of the CIA's aggregate budget. Although Mr. Colby notes that the CIA's total budget figure would allow governments to "refine their estimates of the activities of a major component of the United States intelligence community," he provides no evidence of *how* the publication of this one figure would increase the other government's knowledge of, for example, the clan-

⁴⁹ Defendant's Answers to Plaintiff's Interrogatories, *Halperin v. Colby*, Civil Action No. 75-0676, United States District Court for the District of Columbia, pp. 3-5. Other knowledgeable figures have reached different conclusions about the effect of publishing the CIA's budget. For example, Elliot Richardson, presently Secretary of Commerce and formerly Secretary of Defense, has stated that publication of the amount of the CIA's expenditures would not be damaging to the national security.

destine operational activities of the CIA.⁵⁰ There would, of course, be some "refinement" if it were known that the CIA's budget was \$X millions rather than \$X + 1 millions. Such refinement goes on at all times, but the question is whether such a gain by hostile powers is sufficient to justify overriding the constitutional requirement that the American people be told how their funds are spent. Having an officially acknowledged budget total does not signal to a hostile power manpower levels in the Clandestine Service, let alone the number of deep cover agents. Having an officially acknowledged aggregate figure does not reveal the cost of a reconnaissance vehicle, let alone its technical capability.

Mr. Colby has maintained that one-time publication of the total amount budgeted for the CIA would set a precedent and that information revealed through successive publication would provide hostile powers with insights into United States intelligence activities.

Of particular importance is Mr. Colby's claim that successive disclosures of the CIA's aggregate budget would eliminate the effectiveness of major technical collection systems like the U-2. A change in the CIA's total budget from one year to the next may be due to a number of factors: inflation, cutbacks in activities, a major reorganization, or long term gains in efficiency, for example. Assuming that an increase in the CIA's budget alerted hostile powers to some change in the Agency's activities, it would not in itself reveal what the new activity was—a new covert action project, more material procurement, or an increase in analytical capability through mechanization. For Mr. Colby's argument to be valid not only must the hostile power be able accurately to determine what the activity is—for instance, a new reconnaissance system—but that power would have to gain, covertly, an enormous amount of tightly guarded information, such as the technological capabilities of the vehicle and the surveillance systems which it contained.⁵¹ It would seem that a hostile power able to gain that information would be able to discover the total of the CIA's budget, a much more widely known figure. The possibility that a hostile power may pierce all the barriers designed to limit dissemination of closely held information cannot be used to justify denying the American people information which the Constitution guarantees them, and which is widely published, and which must be assumed to be within the grasp of hostile powers.

It is far from clear, moreover, that the development and introduction of a major new system will be announced by a change in the Agency's total budget.

The CIA budget may be large enough not to change substantially when a new system comes on line. A preliminary analysis of past CIA budgets has indicated that major new activities have not always resulted in "bumps" and that some "lumps" in the budget still are not

⁵⁰ Mr. Colby's statement ignores the fact that figures for the CIA budget are already widely publicized, although not officially confirmed. In this regard, it is interesting to note that the Central Intelligence Agency withdrew its objection to the far more detailed budget disclosure in *The CIA and the Cult of Intelligence* by Victor Marchetti and John D. Marks.

⁵¹ Beyond that, a hostile power would also have to have both a capability and an inclination to take those steps necessary to counter the system.

generally understood.⁵² Because of the importance of expensive technical collection systems, however, the Select Committee believes that the "conspicuous bump" argument deserves fuller study by the future oversight committees,⁵³ particularly in light of the results of the publication of the aggregate figure for national intelligence recommended by the Committee.

Finally, the claims about damage to the national security resulting from publication of the aggregate figure for each intelligence agency must be viewed in the light of far more detailed, and continuing, exposure of the budgets of other agencies vital to the national security. Enormous amounts of information have been provided to the public, for instance, about the work of the Department of Defense and the Atomic Energy Commission. Yet disclosure of funds appropriated and expended by these agencies did not and does not reveal vital national secrets. As Senator Symington noted, "There's nothing secret about the . . . cost of a nuclear aircraft carrier or the cost of the C-5A." But "knowledge of the cost does not equal knowledge of how the weapons operate or how they would be utilized." Similarly, knowledge "of the overall cost of intelligence does not in any way entail the release of information about how the various intelligence groups function, or plan to function."⁵⁴

E. THE ARGUMENT THAT PUBLICATION OF ANY INFORMATION WILL INEVITABLY RESULT IN DEMANDS FOR FURTHER INFORMATION

Some opponents of budget disclosure, while admitting that publishing aggregate figures for the intelligence community or intelligence agencies will not harm national security, have argued that publication of such figures will inevitably lead to demands for ever more detail. As Director Colby told the House Select Committee on Intelligence:

Moreover, once the budget total is revealed, the demand for details probably would grow. What does it include? What does it exclude? Why did it go up? Why did it go down? Is it worth it? How does it work?

⁵² One series of activities which did cause a bump in the CIA's budget was the Agency's activities in Laos, which were clearly known to powers hostile to the U.S. but were kept secret from the American people for many years.

⁵³ If new systems would be revealed by "bumps" in the CIA's budget a solution other than denying all information on CIA expenditures to the American people might be found. James Schlesinger has suggested that the published figure could be based on actual dollars spent by the CIA rather than on the dollars which could be spent; while obligations may fluctuate dramatically over the years, actual outlays "tend to move smoothly over a period of years." (Schlesinger, 2/2/76, p. 55.)

⁵⁴ 117 Cong. Rec., p. 842025, remarks of Sen. Symington. As Congressman Leggett (the House Armed Services Committee) noted: "We have a book here, the Committee Report of about 4000 secrets of the Department of Defense in which they talk about the money for the SAM-D but yet do we know how the SAM-D works? The answer is: no."

"We have the details of the money for Thailand, and it is spelled out. But do we know what the money is actually used for? No."

"We can go through the FBI budget. Does that tell us what they are doing? The answer is: no." (Cong. Rec., H0371, daily ed., 10/1/75, remarks of Rep. Leggett.)

There would be revelations . . . which would gradually reduce the unknown to a smaller and smaller part of the total, permitting foreign intelligence services to concentrate their efforts in the areas where we would least like to attract their attention.

We—and I specifically mean in this instance both intelligence professionals and Members of Congress—would have an acute problem when the matter of our budget arose in the floor of the House or Senate. Those who knew the facts would have two unpleasant choices—to remain silent in the face of all questions and allegations, however inaccurate, or to attempt to keep the debate on accurate grounds by at least hinting at the full story.

My concern that one revelation will lead to another is based on more than a "feeling." The atomic weapons budget was considered very sensitive, and the Manhattan Project was concealed completely during World War II. With the establishment of the AEC, however, the decision was made to include in the 1947 budget a one-line item for the weapons account. That limitation was short-lived. By 1974, a 15-page breakout and discussion of the Atomic Weapons Program was being published. Were the intelligence budget to undergo a similar experience, major aspects of our intelligence strategy, capabilities and successes would be revealed.⁵⁵

⁵⁵ William Colby testimony, House Select Committee on Intelligence, 8/4/75, p. 122.

Senator McClellan described the consequences of publishing the total budget for national intelligence. "That is when you intend to put the camel's nose under the tent. That is the beginning. That is the wedge. You say you do not want to know all the details and how the money is spent. But, if you get the overall figures of one billion dollars or half-a-billion dollars or five billion, or whatever, then how are you going to know, how can you evaluate, how can you judge or make an intelligent judgment on whether that is too much or too little, whether it is being expended wisely or unwisely, except when you can get the details?"

"How? You cannot know. And, if you receive these figures and if you end this ignorance as to the total amount, next you will want to end the ignorance as to the different agencies and how it is spent, and through whom it is spent. Next will want to end the ignorance of what it is spent for. Next you want to end the ignorance of how that intelligence is procured. There is no end to it." (Cong. Rec. S9609, daily ed., 6/4/74, remarks of Sen. McClellan.)

During the same debate Senator Humphrey noted that while he did not oppose the purpose of the disclosure of the total budget for national intelligence, "the problem is it is sort of like loose string or a ball of twine, so to speak, that starts to unravel." (*Id.* at S9606, remarks of Sen. Humphrey.) During a more recent House debate on the publication of the CIA's budget Congressman Young described such publication as "the first baby step." (Cong. Rec. H9376, daily ed., 10/1/76, remarks of Rep. Young.)

As James Schlesinger told the Select Committee, "But one of the problems here is the camel's nose under the edge of the tent, and I think that that is the fundamental problem in the area. There are very few people who can articulately argue that the publication of those figures in and of themselves, if it stopped there, would be harmful. The argument is that then the pressure would build up to do something else, that once you have published for example the . . . budget, that the pressures would build up to reveal the kinds of systems that are being bought for that money, and it is regarded as the first step down a slippery slope for those who worry about those kinds of things." (Schlesinger, 2/2/76, p. 58.)

There are several problems with this argument. While there obviously will be pressure, the problem as Mr. Helms agreed "is not insuperable."⁵⁶ For many years Congress has refused to reveal the figures for the national intelligence budget and the aggregate budgets of the intelligence agencies. It seems unlikely that given this past history, Congress will suddenly reverse itself and fail to protect information whose disclosure would harm the national security. Much more likely is that Congress will, as Senator Church proposed, "establish very stringent rules when it came to handling the money figures."⁵⁷

More importantly, as Congressman Koch noted :

The real fear on both sides of the aisle that some have expressed is, "Gee, if we do that, that is the first step."

Maybe it is, but, whatever the second step is, it is what this House wants it to be, and if this House decides that this is the last step, so be it. If the House decides that it wants to have more information it will have to have a vote on it.

What is wrong with that? That is what is called the democratic system. We are sent here to be part of that system.⁵⁸

It is instructive to note in this context the amount of budgetary information provided on the Atomic Energy Commission. That information has constantly increased. Yet each step of the way, Congress has had the opportunity to limit disclosure and chose not to. This experience confirms congressional control over the process. More importantly the national security was not harmed by disclosure of a substantial amount of budgetary information about an agency and a weapons program crucial to the defense of the United States.

Finally, the argument is without limits. It could be used to justify much greater secrecy. It could be used to justify the withholding of all information on the Defense Department because information which the Congress wishes to protect would be threatened by pressures caused by the publication of any information on that Department.

F. THE ARGUMENT THAT THE UNITED STATES SHOULD NOT PUBLISH INFORMATION OF ITS INTELLIGENCE BUDGET SINCE NO OTHER GOVERNMENT IN THE WORLD DOES

It has also been argued that the United States should not publish its intelligence budget when no other government in the world does.⁵⁹ Yet as Congressman Moss noted :

I point out to those Members who do not know the difference between this country and others, and the fact that we become unique in disclosing this that, thank God, we do become unique. We have grown great and maintained our strength as an open society and we should continue to be an open society to the maximum consistent with our true security requirements.

⁵⁶ Helms, 1/30/76, p. 39.

⁵⁷ *Ibid.*

⁵⁸ Cong. Rec. H9359, daily ed., 10/1/75, remarks of Rep. Koch.

⁵⁹ William Colby testimony, House Select Committee on Intelligence, 8/4/75, p. 120.

I do not want us to emulate the Russians or the Chinese or even our British brethren in the operation of the various agencies of their governments under their official secrets acts and other areas. I want us to realize the strength that we gain from an alert electorate and informed electorate.⁶⁰

G. SUMMARY AND CONCLUSION

The budget procedures which presently govern the Central Intelligence Agency and other agencies of the intelligence community prevent most Members of Congress as well as the public from knowing how much money is spent by any of these agencies or even how much is spent on intelligence as a whole. In addition, most Members of Congress and the public are deceived about the appropriations and expenditures of other government agencies whose budgets are inflated to conceal funds for the intelligence community. The failure to provide this information to the public and to the Congress prevents either from effectively ordering priorities and violates Article 1, Section 9, Clause 7, which provides that:

No Money shall be drawn from the Treasury but in Consequence of Appropriations made by Law; and a regular Statement and Account of the Receipts and Expenditures of all public Money shall be published from time to time.

The Committee finds that publication of the aggregate figure for national intelligence would begin to satisfy the constitutional requirement and would not damage the national security. While substantial questions remain about the relationship between the constitutional requirement and the national security, the Committee recommends the annual publication of the aggregate figure. The Committee also recommends that any successor committees study the effects of publishing more detailed information on the budgets of the intelligence agencies.

⁶⁰ Cong. Rec. H9863, daily ed., 10/1/78. *Remarks of Rep. Moss.*

XVII. TESTING AND USE OF CHEMICAL AND BIOLOGICAL AGENTS BY THE INTELLIGENCE COMMUNITY

Under its mandate¹ the Select Committee has studied the testing and use of chemical and biological agents by intelligence agencies. Detailed descriptions of the programs conducted by intelligence agencies involving chemical and biological agents will be included in a separately published appendix to the Senate Select Committee's report. This section of the report will discuss the rationale for the programs, their monitoring and control, and what the Committee's investigation has revealed about the relationships among the intelligence agencies and about their relations with other government agencies and private institutions and individuals.²

Fears that countries hostile to the United States would use chemical and biological agents against Americans or America's allies led to the development of a defensive program designed to discover techniques for American intelligence agencies to detect and counteract chemical and biological agents. The defensive orientation soon became secondary as the possible use of these agents to obtain information from, or gain control over, enemy agents became apparent.

Research and development programs to find materials which could be used to alter human behavior were initiated in the late 1940s and early 1950s. These experimental programs originally included testing of drugs involving witting human subjects, and culminated in tests using unwitting, nonvolunteer human subjects. These tests were designed to determine the potential effects of chemical or biological agents when used operationally against individuals unaware that they had received a drug.

The testing programs were considered highly sensitive by the intelligence agencies administering them. Few people, even within the agencies, knew of the programs and there is no evidence that either the executive branch or Congress were ever informed of them. The highly compartmented nature of these programs may be explained in part by an observation made by the CIA Inspector General that, "the knowledge that the Agency is engaging in unethical and illicit activi-

¹ Senate Resolution 21 directs the Senate Select Committee on Intelligence Activities to investigate a number of issues:

"(a) Whether agencies within the intelligence community conducted illegal domestic activities (Section 2(1) and (2));

"(b) The extent to which agencies within the intelligence community cooperate (Section 2(4) and (8));

"(c) The adequacy of executive branch and congressional oversight of intelligence activities (Section 2(7) and (11));

"(d) The adequacy of existing laws to safeguard the rights of American citizens (Section 2(13))."

² The details of these programs may never be known. The programs were highly compartmented. Few records were kept. What little documentation existed for the CIA's principal program was destroyed early in 1978.

ties would have serious repercussions in political and diplomatic circles and would be detrimental to the accomplishment of its missions."³

The research and development program, and particularly the covert testing programs, resulted in massive abridgments of the rights of American citizens, sometimes with tragic consequences. The deaths of two Americans^{3a} can be attributed to these programs; other participants in the testing programs may still suffer from the residual effects. While some controlled testing of these substances might be defended, the nature of the tests, their scale, and the fact that they were continued for years after the danger of surreptitious administration of LSD to unwitting individuals was known, demonstrate a fundamental disregard for the value of human life.

The Select Committee's investigation of the testing and use of chemical and biological agents also raise serious questions about the adequacy of command and control procedures within the Central Intelligence Agency and military intelligence, and about the relationships among the intelligence agencies, other governmental agencies, and private institutions and individuals. The CIA's normal administrative controls were waived for programs involving chemical and biological agents to protect their security. According to the head of the Audit Branch of the CIA, these waivers produced "gross administrative failures." They prevented the CIA's internal review mechanisms (the Office of General Counsel, the Inspector General, and the Audit Staff) from adequately supervising the programs. In general, the waivers had the paradoxical effect of providing less restrictive administrative controls and less effective internal review for controversial and highly sensitive projects than those governing normal Agency activities.

The security of the programs was protected not only by waivers of normal administrative controls, but also by a high degree of compartmentation within the CIA. This compartmentation excluded the CIA's Medical Staff from the principal research and testing program employing chemical and biological agents.

It also may have led to agency policymakers receiving differing and inconsistent responses when they posed questions to the CIA component involved.

Jurisdictional uncertainty within the CIA was matched by jurisdictional conflict among the various intelligence agencies. A spirit of cooperation and reciprocal exchanges of information which initially characterized the programs disappeared. Military testers withheld information from the CIA, ignoring suggestions for coordination from their superiors. The CIA similarly failed to provide information to the military on the CIA's testing program. This failure to cooperate was conspicuously manifested in an attempt by the Army to conceal

³ CIA Inspector General's Survey of TSD, 1957, p. 217.

^{3a} On January 8, 1958, Mr. Harold Blauer died of circulatory collapse and heart failure following an intravenous injection of a synthetic mescaline derivative while a subject of tests conducted by New York State Psychiatric Institute under a contract let by the U.S. Army Chemical Corps. The Committee's investigation into drug testing by U.S. intelligence agencies focused on the testing of LSD, however, the committee did receive a copy of the U.S. Army Inspector General's Report, issued on October 1975, on the events and circumstances of Mr. Blauer's death. His death was directly attributable to the administration of the synthetic mescaline derivative.

their overseas testing program, which included surreptitious administration of LSD, from the CIA. Learning of the Army's program, the Agency surreptitiously attempted to obtain details of it.

The decision to institute one of the Army's LSD field testing projects had been based, at least in part, on the finding that no long-term residual effects had ever resulted from the drug's administration. The CIA's failure to inform the Army of a death which resulted from the surreptitious administration of LSD to unwitting Americans, may well have resulted in the institution of an unnecessary and potentially lethal program.

The development, testing, and use of chemical and biological agents by intelligence agencies raises serious questions about the relationship between the intelligence community and foreign governments, other agencies of the Federal Government, and other institutions and individuals. The questions raised range from the legitimacy of American complicity in actions abroad which violate American and foreign laws to the possible compromise of the integrity of public and private institutions used as cover by intelligence agencies.

A. THE PROGRAMS INVESTIGATED

1. Project CHATTER

Project CHATTER was a Navy program that began in the fall of 1947. Responding to reports of "amazing results" achieved by the Soviets in using "truth drugs," the program focused on the identification and testing of such drugs for use in interrogations and in the recruitment of agents. The research included laboratory experiments on animals and human subjects involving *Anabasis aphylla*, scopolamine, and mescaline in order to determine their speech-inducing qualities. Overseas experiments were conducted as part of the project.

The project expanded substantially during the Korean War, and ended shortly after the war, in 1953.

2. Project BLUEBIRD/ARTICHOKE

The earliest of the CIA's major programs involving the use of chemical and biological agents, Project BLUEBIRD, was approved by the Director in 1950. Its objectives were:

- (a) discovering means of conditioning personnel to prevent unauthorized extraction of information from them by known means, (b) investigating the possibility of control of an individual by application of special interrogation techniques, (c) memory enhancement, and (d) establishing defensive means for preventing hostile control of Agency personnel.⁴

As a result of interrogations conducted overseas during the project, another goal was added—the evaluation of offensive uses of unconventional interrogation techniques, including hypnosis and drugs. In August 1951, the project was renamed ARTICHOKE. Project ARTICHOKE included in-house experiments on interrogation techniques, conducted "under medical and security controls which would ensure

⁴ CIA memorandum to the Select Committee, "Behavioral Drugs and Testing," 2/11/76.

that no damage was done to individuals who volunteer for the experiments." Over seas interrogations utilizing a combination of sodium pentothal and hypnosis after physical and psychiatric examinations of the subjects were also part of ARTICHOKE.

The Office of Scientific Intelligence (OSI), which studied scientific advances by hostile powers, initially led BLUEBIRD/ARTICHOKE efforts. In 1952, overall responsibility for ARTICHOKE was transferred from OSI to the Inspection and Security Office (I&SO), predecessor to the present Office of Security. The CIA's Technical Services and Medical Staffs were to be called upon as needed; OSI would retain liaison function with other government agencies.⁶ The change in leadership from an intelligence unit to an operating unit apparently reflected a change in emphasis; from the study of actions by hostile powers to the use, both for offensive and defensive purposes, of special interrogation techniques—primarily hypnosis and truth serums.

Representatives from each Agency unit involved in ARTICHOKE met almost monthly to discuss their progress. These discussions included the planning of overseas interrogations⁶ as well as further experimentation in the U.S.

Information about project ARTICHOKE after the fall of 1953 is scarce. The CIA maintains that the project ended in 1956, but evidence suggests that Office of Security and Office of Medical Services use of "special interrogation" techniques continued for several years thereafter.

3. MKNAOMI

MKNAOMI was another major CIA program in this area. In 1967, the CIA summarized the purposes of MKNAOMI:

(a) To provide for a covert support base to meet clandestine operational requirements.

(b) To stockpile severely incapacitating and lethal materials for the specific use of TSD [Technical Services Division].

(c) To maintain in operational readiness special and unique items for the dissemination of biological and chemical materials.

(d) To provide for the required surveillance, testing, upgrading, and evaluation of materials and items in order to assure absence of defects and complete predictability of results to be expected under operational conditions.⁹

Under an agreement reached with the Army in 1952, the Special Operations Division (SOD) at Fort Detrick was to assist CIA in developing, testing, and maintaining biological agents and delivery

⁶ Memorandum from Robert Taylor, O/D/P to the Assistant Deputy (Inspection and Security) and Chief of the Medical Staff, 3/22/52.

⁷ Memorandum from H. Marshall Chadwell, Assistant Director, Scientific Intelligence, to the Deputy Director/Plans (DDP) "Protect ARTICHOKE," 8/20/52.

⁸ "Progress Report, Project ARTICHOKE," 1/12/53.

⁹ Memorandum from Chief, TSD/Biological Branch to Chief, TSD "MKNAOMI: Funding, Objectives, and Accomplishments," 10/18/67, p. 1. For a fuller description of MKNAOMI and the relationship between CIA and SOD, see p. 360 ff.

systems. By this agreement, CIA acquired the knowledge, skill, and facilities of the Army to develop biological weapons suited for CIA use.

SOD developed darts coated with biological agents and pills containing several different biological agents which could remain potent for weeks or months. SOD also developed a special gun for firing darts coated with a chemical which could allow CIA agents to incapacitate a guard dog, enter an installation secretly, and return the dog to consciousness when leaving. SOD scientists were unable to develop a similar incapacitant for humans. SOD also physically transferred to CIA personnel biological agents in "bulk" form, and delivery devices, including some containing biological agents.

In addition to the CIA's interest in biological weapons for use against humans, it also asked SOD to study use of biological agents against crops and animals. In its 1967 memorandum, the CIA stated:

Three methods and systems for carrying out a covert attack against crops and causing severe crop loss have been developed and evaluated under field conditions. This was accomplished in anticipation of a requirement which was later developed but was subsequently scrubbed just prior to putting into action.^{9a}

MKNAOMI was terminated in 1970. On November 25, 1969, President Nixon renounced the use of any form of biological weapons that kill or incapacitate and ordered the disposal of existing stocks of bacteriological weapons. On February 14, 1970, the President clarified the extent of his earlier order and indicated that toxins—chemicals that are not living organisms but are produced by living organisms—were considered biological weapons subject to his previous directive and were to be destroyed. Although instructed to relinquish control of material held for the CIA by SOD, a CIA scientist acquired approximately 11 grams of shellfish toxin from SOD personnel at Fort Detrick which were stored in a little-used CIA laboratory where it went undetected for five years.¹⁰

4. MKULTRA

MKULTRA was the principal CIA program involving the research and development of chemical and biological agents. It was "concerned with the research and development of chemical, biological, and radiological materials capable of employment in clandestine operations to control human behavior."¹¹

In January 1973, MKULTRA records were destroyed by Technical Services Division personnel acting on the verbal orders of Dr. Sidney Gottlieb, Chief of TSD. Dr. Gottlieb has testified, and former Director Helms has confirmed, that in ordering the records destroyed, Dr. Gottlieb was carrying out the verbal order of then DCI Helms.

MKULTRA began with a proposal from the Assistant Deputy Director for Plans, Richard Helms, to the DCI, outlining a special

^{9a} *Ibid.*, p. 2.

¹⁰ Senate Select Committee, 9/16/75, Hearings, Vo. 1.

¹¹ Memorandum from the CIA Inspector General to the Director, 7/26/63.

funding mechanism for highly sensitive CIA research and development projects that studied the use of biological and chemical materials in altering human behavior. The projects involved :

Research to develop a capability in the covert use of biological and chemical materials. This area involves the production of various physiological conditions which could support present or future clandestine operations. Aside from the offensive potential, the development of a comprehensive capability in this field of covert chemical and biological warfare gives us a thorough knowledge of the enemy's theoretical potential, thus enabling us to defend ourselves against a foe who might not be as restrained in the use of these techniques as we are.¹²

MKULTRA was approved by the DCI on April 13, 1953 along the lines proposed by ADDP Helms.

Part of the rationale for the establishment of this special funding mechanism was its extreme sensitivity. The Inspector General's survey of MKULTRA in 1963 noted the following reasons for this sensitivity :

a. Research in the manipulation of human behavior is considered by many authorities in medicine and related fields to be professionally unethical, therefore the reputation of professional participants in the MKULTRA program are on occasion in jeopardy.

b. Some MKULTRA activities raise questions of legality implicit in the original charter.

c. A final phase of the testing of MKULTRA products places the rights and interests of U.S. citizens in jeopardy.

d. Public disclosure of some aspects of MKULTRA activity could induce serious adverse reaction in U.S. public opinion, as well as stimulate offensive and defensive action in this field on the part of foreign intelligence services.¹³

Over the ten-year life of the program, many "additional avenues to the control of human behavior" were designated as appropriate for investigation under the MKULTRA charter. These include "radiation, electroshock, various fields of psychology, psychiatry, sociology, and anthropology, graphology, harassment substances, and paramilitary devices and materials."¹⁴

The research and development of materials to be used for altering human behavior consisted of three phases: first, the search for materials suitable for study; second, laboratory testing on voluntary human subjects in various types of institutions; third, the application of MKULTRA materials in normal life settings.

The search for suitable materials was conducted through standing arrangements with specialists in universities, pharmaceutical houses, hospitals, state and federal institutions, and private research organi-

¹² Memorandum from ADDP Helms to DCI Dulles, 4/3/53, Tab A, pp. 1-2.

¹³ I.G. Report on MKULTRA, 1963, pp. 1-2.

¹⁴ *Ibid.*, p. 4.

zations. The annual grants of funds to these specialists were made under ostensible research foundation auspices, thereby concealing the CIA's interest from the specialist's institution.

The next phase of the MKULTRA program involved physicians, toxicologists, and other specialists in mental, narcotics, and general hospitals, and in prisons. Utilizing the products and findings of the basic research phase, they conducted intensive tests on human subjects.

One of the first studies was conducted by the National Institute of Mental Health. This study was intended to test various drugs, including hallucinogenics, at the NIMH Addiction Research Center in Lexington, Kentucky. The "Lexington Rehabilitation Center," as it was then called, was a prison for drug addicts serving sentences for drug violations.

The test subjects were volunteer prisoners who, after taking a brief physical examination and signing a general consent form, were administered hallucinogenic drugs. As a reward for participation in the program, the addicts were provided with the drug of their addiction.

LSD was one of the materials tested in the MKULTRA program. The final phase of LSD testing involved surreptitious administration to unwitting nonvolunteer subjects in normal life settings by undercover officers of the Bureau of Narcotics acting for the CIA.

The rationale for such testing was "that testing of materials under accepted scientific procedures fails to disclose the full pattern of reactions and attributions that may occur in operational situations."¹⁵

According to the CIA, the advantage of the relationship with the Bureau was that

test subjects could be sought and cultivated within the setting of narcotics control. Some subjects have been informers or members of suspect criminal elements from whom the [Bureau of Narcotics] has obtained results of operational value through the tests. *On the other hand, the effectiveness of the substances on individuals at all social levels, high and low, native American and foreign, is of great significance and testing has been performed on a variety of individuals within these categories.* [Emphasis added.]¹⁶

A special procedure, designated MKDELTA, was established to govern the use of MKULTRA materials abroad. Such materials were used on a number of occasions. Because MKULTRA records were destroyed, it is impossible to reconstruct the operational use of MKULTRA materials by the CIA overseas; it has been determined that the use of these materials abroad began in 1953, and possibly as early as 1950.

Drugs were used primarily as an aid to interrogations, but MKULTRA/MKDELTA materials were also used for harassment, discrediting, or disabling purposes. According to an Inspector General Survey of the Technical Services Division of the CIA in 1957—an inspection which did not discover the MKULTRA project involving the surreptitious administration of LSD to unwitting, nonvolunteer

¹⁵ *Ibid.*, p. 21.

¹⁶ *Ibid.*, pp. 11-12.

subjects—the CIA had developed six drugs for operational use and they had been used in six different operations on a total of thirty-three subjects.¹⁷ By 1963 the number of operations and subjects had increased substantially.

In the spring of 1963, during a wide-ranging Inspector General survey of the Technical Services Division, a member of the Inspector General's staff, John Vance, learned about MKULTRA and about the project involving the surreptitious administration of LSD to unwitting, nonvoluntary human subjects. As a result of the discovery and the Inspector General's subsequent report, this testing was halted and much tighter administrative controls were imposed on the program. According to the CIA, the project was decreased significantly each budget year until its complete termination in the late 1960s.

5. The Testing of LSD by the Army

There were three major phases in the Army's testing of LSD. In the first, LSD was administered to more than 1,000 American soldiers who volunteered to be subjects in chemical warfare experiments. In the second phase, Material Testing Program EA 1729, 95 volunteers received LSD in clinical experiments designed to evaluate potential intelligence uses of the drug. In the third phase, Projects THIRD CHANCE and DERBY HAT, 16 unwitting nonvolunteer subjects were interrogated after receiving LSD as part of operational field tests.

B. CIA DRUG TESTING PROGRAMS

1. The Rationale for the Testing Programs

The late 1940s and early 1950s were marked by concern over the threat posed by the activities of the Soviet Union, the People's Republic of China, and other Communist bloc countries. United States concern over the use of chemical and biological agents by these powers was acute. The belief that hostile powers had used chemical and biological agents in interrogations, brainwashing, and in attacks designed to harass, disable, or kill Allied personnel created considerable pressure for a "defensive" program to investigate chemical and biological agents so that the intelligence community could understand the mechanisms by which these substances worked and how their effects could be defeated.¹⁸

Of particular concern was the drug LSD. The CIA had received reports that the Soviet Union was engaged in intensive efforts to produce LSD; and that the Soviet Union had attempted to purchase the world's supply of the chemical. As one CIA officer who was deeply involved in work with this drug described the climate of the times: "[It] is awfully hard in this day and age to reproduce how frightening all of this was to us at the time, particularly after the drug scene has become as widespread and as knowledgeable in this country as it did. But we were literally terrified, because this was the one material that we

¹⁷ *Ibid.*, 1967, p. 201.

¹⁸ Thus an officer in the Office of Security of the OIA stressed the "urgency of the discovery of techniques and method that would permit our personnel, in the event of their capture by the enemy, to resist or defeat enemy interrogation." (Minutes of the ARTICHOKE conference of 10/22/58.)

had ever been able to locate that really had potential fantastic possibilities if used wrongly"¹⁹

But the defensive orientation soon became secondary. Chemical and biological agents were to be studied in order "to perfect techniques . . . for the abstraction of information from individuals whether willing or not" and in order to "develop means for the control of the activities and mental capacities of individuals whether willing or not."²⁰ One Agency official noted that drugs would be useful in order to "gain control of bodies whether they were willing or not" in the process of removing personnel from Europe in the event of a Soviet attack.²¹ In other programs, the CIA began to develop, produce, stockpile, and maintain in operational readiness materials which could be used to harass, disable, or kill specific targets.²²

Reports of research and development in the Soviet Union, the People's Republic of China, and the Communist Bloc countries provided the basis for the transmutation of American programs from a defensive to an offensive orientation. As the Chief of the Medical Staff of the Central Intelligence Agency wrote in 1952:

There is ample evidence in the reports of innumerable interrogations that the Communists were utilizing drugs, physical duress, electric shock, and possibly hypnosis against their enemies. With such evidence it is difficult not to keep from becoming rabid about our apparent laxity. We are forced by this mounting evidence to assume a more aggressive role in the development of these techniques, but must be cautious to maintain strict inviolable control because of the havoc that could be wrought by such techniques in unscrupulous hands.²³

In order to meet the perceived threat to the national security, substantial programs for the testing and use of chemical and biological agents—including projects involving the surreptitious administration of LSD to unwitting nonvolunteer subjects "at all social levels, high and low, native American and foreign"—were conceived, and implemented. These programs resulted in substantial violations of the rights of individuals within the United States.

¹⁹ Testimony of CIA officer, 11/21/75, p. 33.

²⁰ Memorandum from the Director of Security to ARTICHOKE representatives, Subject: "ARTICHOKE Restatement of Program."

²¹ ARTICHOKE memorandum, 7/30/53.

²² The Inspector General's Report of 1957 on the Technical Services Division noted that "Six specific products have been developed and are available for operational use. Three of them are discrediting and disabling materials which can be administered unwittingly and permit the exercise of a measure of control over the actions of the subject."

A memorandum for the Chief, TSD, Biological Branch to the Chief, TSD, 10/18/67, described two of the objectives of the CIA's Project MKNAOMI as: "to stockpile severely incapacitating and lethal materials for the specific use of TSD" and "to maintain in operational readiness special and unique items for the dissemination of biological and chemical materials."

²³ Memorandum from the Chief of the Medical Staff, 1/25/52.

Although the CIA recognized these effects of LSD to unwitting individuals within the United States, the project continued.²⁴ As the Deputy Director for Plans, Richard Helms, wrote the Deputy Director of Central Intelligence during discussions which led to the cessation of unwitting testing:

While I share your uneasiness and distaste for any program which tends to intrude upon an individual's private and legal prerogatives I believe it is necessary that the Agency maintain a central role in this activity, keep current on enemy capabilities the manipulation of human behavior, and maintain an offensive capability.²⁵

There were no attempts to secure approval for the most controversial aspects of these programs from the executive branch or Congress. The nature and extent of the programs were closely held secrets; even DCI McCone was not briefed on all the details of the program involving the surreptitious administration of LSD until 1963. It was deemed imperative that these programs be concealed from the American people. As the CIA's Inspector General wrote in 1957:

Precautions must be taken not only to protect operations from exposure to enemy forces but also to conceal these activities from the American public in general. The knowledge that the Agency is engaging in unethical and illicit activities would have serious repercussions in political and diplomatic circles and would be detrimental to the accomplishment of its mission.²⁶

2. The Death of Dr. Frank Olson

The most tragic result of the testing of LSD by the CIA was the death of Dr. Frank Olson, a civilian employee of the Army, who died on November 27, 1953. His death followed his participation in a CIA experiment with LSD. As part of this experiment, Olson unwittingly received approximately 70 micrograms of LSD in a glass of Cointreau he drank on November 19, 1953. The drug had been placed in the bottle by a CIA officer, Dr. Robert Lashbrook, as part of an experiment he and Dr. Sidney Gottlieb performed at a meeting of Army and CIA scientists.

Shortly after this experiment, Olson exhibited symptoms of paranoia and schizophrenia. Accompanied by Dr. Lashbrook, Olson sought psychiatric assistance in New York City from a physician, Dr. Harold Abramson, whose research on LSD had been funded indirectly by the CIA. While in New York for treatment, Olson fell to his death from a tenth story window in the Statler Hotel.

²⁴ Even during the discussions which led to the termination of the unwitting testing, the DDP turned down the option of halting such tests within the U.S. and continuing them abroad despite the fact that the Technical Services Division had conducted numerous operations abroad making use of LSD. The DDP made this decision on the basis of security noting that the past efforts overseas had resulted in "making an inordinate number of foreign nationals unwitting of our role in the very sensitive activity." (Memorandum for the Deputy Director of Central Intelligence from the Deputy Director for Plans, 12/17/63, p. 2.)

²⁵ *Ibid.*, pp. 2-3.

²⁶ I.G. survey of TSD, 1957, p. 217.

a. Background.—Olson, an expert in aerobiology who was assigned to the Special Operations Division (SOD) of the U.S. Army Biological Center at Camp Detrick, Maryland. This Division had three primary functions:

- (1) assessing the vulnerability of American installations to biological attack;
- (2) developing techniques for offensive use of biological weapons; and
- (3) biological research for the CIA.²⁷

Professionally, Olson was well respected by his colleagues in both the Army and the CIA. Colonel Vincent Ruwet, Olson's immediate superior at the time of his death, was in almost daily contact with Olson. According to Colonel Ruwet: "As a professional man . . . his ability . . . was outstanding."²⁸ Colonel Ruwet stated that "during the period prior to the experiment . . . I noticed nothing which would lead me to believe that he was of unsound mind."²⁹ Dr. Lashbrook, who had monthly contacts with Olson from early 1952 until the time of his death, stated publicly that before Olson received LSD, "as far as I know, he was perfectly normal."³⁰ This assessment is in direct contradiction to certain statements evaluating Olson's emotional stability made in CIA internal memoranda written after Olson's death.

b. The Experiment.—On November 18, 1953, a group of ten scientists from the CIA and Camp Detrick attended a semi-annual review and analysis conference at a cabin located at Deep Creek Lake, Maryland. Three of the participants were from the CIA's Technical Services Staff. The Detrick representatives were all from the Special Operations Division.

According to one CIA official, the Special Operations Division participants "agreed that an unwitting experiment would be desirable."³¹ This account directly contradicts Vincent Ruwet's recollection. Ruwet recalls no such discussion, and has asserted that he would remember any such discussion because the SOD participants would have strenuously objected to testing on unwitting subjects.³²

In May, 1953, Richard Helms, Assistant DDP, held a staff meeting which the Chief of Technical Services Staff attended. At this meeting Helms "indicated that the drug [LSD] was dynamite and that he should be advised at all times when it was intended to use it."³³ In addition, the then DDP, Frank Wisner, sent a memorandum to TSS stating the requirement that the DDP personally approve the use of LSD. Gottlieb went ahead with the experiment,³⁴ securing the ap-

²⁷ Staff summary of Vincent Ruwet interview, 8/13/75, p. 3.

²⁸ Memorandum of Col. Vincent Ruwet, To Whom It May Concern, no date, p. 2.

²⁹ Ruwet Memorandum, p. 3.

³⁰ Joseph B. Treaster, *New York Times*, 7/19/75, p. 1.

³¹ Memorandum for the Record from Lyman Kirkpatrick, 12/1/53, p. 1.

³² Ruwet (staff summary), 8/13/75, p. 6.

³³ Inspector General Diary, 12/2/53.

³⁴ *Ibid.* Dr. Gottlieb has testified that he does not remember either the meeting with Helms nor the Wisner memorandum. (Gottlieb, 10/18/75, p. 16.)

proval of his immediate supervisor. Neither the Chief of TSS nor the DDP specifically authorized the experiment in which Dr. Olson participated.³⁵

According to Gottlieb,³⁶ a "very small dose" of LSD was placed in a bottle of Cointreau which was served after dinner on Thursday, November 19. The drug was placed in the liqueur by Robert Lashbrook. All but two of the SOD participants received LSD. One did not drink; the other had a heart condition.³⁷ About twenty minutes after they finished their Cointreau, Gottlieb informed the other participants that they had received LSD.

Dr. Gottlieb stated that "up to the time of the experiment," he observed nothing unusual in Olson's behavior.^{37a} Once the experiment was underway, Gottlieb recalled that "the drug had a definite effect on the group to the point that they were boisterous and laughing and they could not continue the meeting or engage in sensible conversation." The meeting continued until about 1:00 a.m., when the participants retired for the evening. Gottlieb recalled that Olson, among others, complained of "wakefulness" during the night.³⁸ According to Gottlieb on Friday morning "aside from some evidence of fatigue, I observed nothing unusual in [Olson's] actions, conversation, or general behavior."³⁹ Ruwet recalls that Olson "appeared to be agitated" at breakfast, but that he "did not consider this to be abnormal under the circumstances."⁴⁰

c. *The Treatment.*—The following Monday, November 23, Olson was waiting for Ruwet when he came in to work at 7:30 a.m. For the next two days Olson's friends and family attempted to reassure him and help him "snap out" of what appeared to be a serious depression. On Tuesday, Olson again came to Ruwet and, after an hour long con-

* Dr. Gottlieb testified that "given the information we knew up to this time, and based on a lot of our own self-administration, we thought it was a fairly benign substance in terms of potential harm." This is in conflict not only with Mr. Helms' statement but also with material which had been supplied to the Technical Services Staff. In one long memorandum on current research with LSD which was supplied to TSD, Henry Beecher described the dangers involved with such research in a prophetic manner. "The second reason to doubt Professor Rothland came when I raised the question as to any accidents which had arisen from the use of LSD-25. He said in a very positive way, 'none.' As it turned out this answer could be called overly positive, for later on in the evening I was discussing the matter with Dr. W. A. Stohl, Jr., a psychiatrist in Bleulera's Clinic in Zurich where I had gone at Rothland's insistence. Stohl, when asked the same question, replied, 'yes,' and added spontaneously, 'there is a case Professor Rothland knows about. In Geneva a woman physician who had been subject to depression to some extent took LSD-25 in an experiment and became severely and suddenly depressed and committed suicide three weeks later. While the connection is not definite, common knowledge of this could hardly have allowed the positive statement Rothland permitted himself. This case is a warning to us to avoid engaging subjects who are depressed, or who have been subject to depression.'" Dr. Gottlieb testified that he had no recollection of either the report or that particular section of it. (Sidney Gottlieb testimony, 10/19/75, p. 78.)

³⁵ Memorandum of Sheffield Edwards for the record, 11/28/53, p. 2.

³⁶ Lashbrook (staff summary), 7/19/75, p. 3.

³⁷ Gottlieb Memorandum, 12/7/53, p. 2.

^{37a} Edwards memorandum, 11/28/53, p. 3.

³⁸ Gottlieb memorandum, 12/7/53, p. 3.

⁴⁰ Ruwet memorandum, p. 3.

versation, it was decided that medical assistance for Dr. Olson was desirable.⁴¹

Ruwet then called Lashbrook and informed him that "Dr. Olson was in serious trouble and needed immediate professional attention."⁴² Lashbrook agreed to make appropriate arrangements and told Ruwet to bring Olson to Washington, D.C. Ruwet and Olson proceeded to Washington to meet with Lashbrook, and the three left for New York at about 2:30 p.m. to meet with Dr. Harold Abramson.

At that time Dr. Abramson was an allergist and immunologist practicing medicine in New York City. He held no degree in psychiatry, but was associated with research projects supported indirectly by the CIA. Gottlieb and Dr. Lashbrook both followed his work closely in the early 1950s.⁴³ Since Olson needed medical help, they turned to Dr. Abramson as the doctor closest to Washington who was experienced with LSD and cleared by the CIA.

Ruwet, Lashbrook, and Olson remained in New York for two days of consultations with Abramson. On Thursday, November 26, 1953, the three flew back to Washington so that Olson could spend Thanksgiving with his family. En route from the airport Olson told Ruwet that he was afraid to face his family. After a lengthy discussion, it was decided that Olson and Lashbrook would return to New York, and that Ruwet would go to Frederick to explain these events to Mrs. Olson.⁴⁴

Lashbrook and Olson flew back to New York the same day, again for consultations with Abramson. They spent Thursday night in a Long Island hotel and the next morning returned to the city with Abramson. In further discussions with Abramson, it was agreed that Olson should be placed under regular psychiatric care at an institution closer to his home.⁴⁵

d. The Death.—Because they could not obtain air transportation for a return trip on Friday night, Lashbrook and Olson made reservations for Saturday morning and checked into the Statler Hotel. Between the time they checked in and 10:00 p.m.; they watched television, visited the cocktail lounge, where each had two martinis, and dinner. According to Lashbrook, Olson "was cheerful and appeared to enjoy the entertainment." He "appeared no longer particularly depressed, and almost the Dr. Olson I knew prior to the experiment."⁴⁶

After dinner Lashbrook and Olson watched television for about an hour, and at 11:00, Olson suggested that they go to bed, saying that "he felt more relaxed and contented than he had since [they] came to New York." Olson then left a call with the hotel operator to wake them in the morning. At approximately 2:30 a.m. Saturday, November 28, Lashbrook was awakened by a loud "crash of glass." In his report on the incident, he stated only that Olson "had crashed through the closed window blind and the closed window and he fell to his death from the window of our room on the 10th floor."⁴⁸

⁴¹ *Ibid.*, p. 4.

⁴² Lashbrook memorandum, 12/7/53, p. 1.

⁴³ Staff summary of Dr. Harold Abramson interview, 7/20/75, p. 2.

⁴⁴ Lashbrook memorandum 12/7/53, p. 3.

⁴⁵ Abramson memorandum, 12/4/53.

⁴⁶ Lashbrook memorandum, 12/7/53, p. 3.

⁴⁷ *Ibid.*, p. 4.

⁴⁸ *Ibid.*

Immediately after finding that Olson had leapt to his death, Lashbrook telephoned Gottlieb at his home and informed him of the incident.⁴⁹ Gottlieb called Ruwet and informed him of Olson's death at approximately 2:45 a.m.⁵⁰ Lashbrook then called the hotel desk and reported the incident to the operator there. Lashbrook called Abramson and informed him of the occurrence. Abramson told Lashbrook he "wanted to be kept out of the thing completely," but later changed his mind and agreed to assist Lashbrook.⁵¹

Shortly thereafter, uniformed police officers and some hotel employees came to Lashbrook's room. Lashbrook told the police he didn't know why Olson had committed suicide, but he did know that Olson "suffered from ulcers."⁵²

e. The Aftermath.—Following Dr. Olson's death, the CIA made a substantial effort to ensure that his family received death benefits, but did not notify the Olsons of the circumstances surrounding his demise. The Agency also made considerable efforts to prevent the death being connected with the CIA, and supplied complete cover for Lashbrook so that his association with the CIA would remain a secret.

After Dr. Olson's death the CIA conducted an internal investigation of the incident. As part of his responsibilities in this investigation, the General Counsel wrote the Inspector General, stating:

I'm not happy with what seems to be a very casual attitude on the part of TSS representatives to the way this experiment was conducted and the remarks that this is just one of the risks running with scientific experimentation. I do not eliminate the need for taking risks, but I do believe, especially when human health or life is at stake, that at least the prudent, reasonable measures which can be taken to minimize the risk must be taken and failure to do so was culpable negligence. The actions of the various individuals concerned after effects of the experiment on Dr. Olson became manifest also revealed the failure to observe normal and reasonable precautions.⁵³

As a result of the investigation DCI Allen Dulles sent a personal letter to the Chief of Technical Operations of the Technical Services Staff who had approved the experiment criticizing him for "poor judgment . . . in authorizing the use of this drug on such an unwitting basis and without proximate medical safeguards."⁵⁴ Dulles also sent a letter to Dr. Gottlieb, Chief of the Chemical Division of the Technical Services Staff, criticizing him for recommending the "unwitting application of the drug" in that the proposal "did not give sufficient emphasis for medical collaboration and for the proper consideration of the rights of the individual to whom it was being administered."⁵⁵

⁴⁹ CIA Field Office Report, 12/8/53, p. 3.

⁵⁰ Ruwet Memorandum, p. 11.

⁵¹ CIA Field Office Report, 12/8/53, p. 3.

⁵² *Ibid.*

⁵³ Memorandum from the General Counsel to the Inspector General, 1/4/54.

⁵⁴ Memorandum from DCI to Chief, Technical Operations, TSS, 2/12/54.

⁵⁵ Memorandum from DCI to Sidney Gottlieb, 2/12/54.

The letters were hand carried to the individuals to be read and returned. Although the letters were critical, a note from the Deputy Director of Central Intelligence to Mr. Helms instructed him to inform the individuals that: "These are not reprimands and no personnel file notation are being made."⁵⁶

Thus, although the Rockefeller Commission has characterized them as such, these notes were explicitly not reprimands. Nor did participation in the events which led to Dr. Olson's death have any apparent effect on the advancement within the CIA of the individuals involved.

3. *The Surreptitious Administration of LSD to Unwitting Non-Volunteer Human Subjects by the CIA After the Death of Dr. Olson*

The death of Dr. Olson could be viewed, as some argued at the time, as a tragic accident, one of the risks inherent in the testing of new substances. It might be argued that LSD was thought to be benign. After the death of Dr. Olson the dangers of the surreptitious administration of LSD were clear, yet the CIA continued or initiated "a project involving the surreptitious administration of LSD to non-volunteer human subjects. This program exposed numerous individuals in the United States to the risk of death or serious injury without their informed consent, without medical supervision, and without necessary follow-up to determine any long-term effects.

Prior to the Olson experiment, the Director of Central Intelligence had approved MKULTRA, a research program designed to develop a "capability in the covert use of biological and chemical agent materials." In the proposal describing MKULTRA Mr. Helms, then ADPP, wrote the Director that:

we intend to investigate the development of a chemical material which causes a reversible non-toxic aberrant mental state, the specific nature of which can be reasonably well predicted for each individual. This material could potentially aid in discrediting individuals, eliciting information, and implanting suggestions and other forms of mental control.⁵⁸

On February 12, 1954, the Director of the Central Intelligence Agency wrote TSS officials criticizing them for "poor judgment" in administering LSD on "an unwitting basis and without proximate medical safeguards" to Dr. Olson and for the lack of "proper consideration of the rights of the individual to whom it was being administered."⁵⁹ On the same day, the Inspector General reviewed a report on Subproject Number 3 of MKULTRA, in which the same TSS officers who had just received letters from the Director were quoted as stating that one of the purposes of Subproject Number 3 was to

⁵⁶ Note from DDCI to Richard Helms, 2/13/54.

⁵⁷ The 1963 IG Report, which described the project involving the surreptitious administration of LSD, placed the project beginning in 1955. Other CIA documents reveal that it was in existence as early as February 1954. The CIA has told the Committee that the project began in 1953 and that the experiment which led to Dr. Olson's death was part of the project.

⁵⁸ Memorandum from ADPP Items to DCI Dulles, 4/8/58, tab A, p. 2.

⁵⁹ Memorandum from DCI to Sidney Gottlieb, 2/12/54; and memorandum from DCI to Chief of Operations, TSS, 2/12/54.

"observe the behavior of unwitting persons being questioned after having been given a drug."⁶⁰ There is no evidence that Subproject Number 3 was terminated even though these officers were unequivocally aware of the dangers of the surreptitious administration of LSD and the necessity of obtaining informed consent and providing medical safeguards. Subproject Number 3, in fact, used methods which showed even less concern than did the OLSON experiment for the safety and security of the participants. Yet the evidence indicates the project continued until 1963.⁶¹

In the project, the individual conducting the test might make initial contact with a prospective subject selected at random in a bar. He would then invite the person to a "safehouse" where the test drug was administered to the subject through drink or in food. CIA personnel might debrief the individual conducting the test, or observe the test by using a one-way mirror and tape recorder in an adjoining room.

Prior consent was obviously not obtained from any of the subjects. There was also, obviously, no medical prescreening. In addition, the tests were conducted by individuals who were not qualified scientific observers. There were no medical personnel on hand either to administer the drugs or to observe their effects, and no follow-up was conducted on the test subjects.

As the Inspector General noted in 1963:

A significant limitation on the effectiveness of such testing is the infeasibility of performing scientific observation of results. The [individuals conducting the test] are not qualified scientific observers. Their subjects are seldom accessible beyond the first hours of the test. The testing may be useful in perfecting delivery techniques, and in identifying surface characteristics of onset, reaction, attribution, and side-effect.⁶²

This was particularly troublesome as in a

number of instances, . . . the test subject has become ill for hours or days, including hospitalization in at least one case, and the agent could only follow up by guarded inquiry after the test subject's return to normal life. Possible sickness and attendant economic loss are inherent contingent effects of the testing.⁶³

Paradoxically, greater care seems to have been taken for the safety of foreign nationals against whom LSD was used abroad. In several cases medical examinations were performed prior to the use of LSD.⁶⁴

⁶⁰ Memorandum to Inspector General from Chief, Inspection and Review, on Subproject #3 of MKULTRA, 2/10/54.

⁶¹ IG Report on MKULTRA, 1963.

⁶² *Ibid.*, p. 12.

⁶³ *Ibid.* According to the IG's survey in 1963, physicians associated with MKULTRA could be made available in an emergency.

⁶⁴ The Technical Services Division which was responsible for the operational use of LSD abroad took the position that "no physical examination of the subject is required prior to administration of [LSD] by TSS trained personnel. A phys-

Moreover, the administration abroad was marked by constant observation made possible because the material was being used against prisoners of foreign intelligence or security organizations. Finally, during certain of the LSD interrogations abroad, local physicians were on call, though these physicians had had no experience with LSD and would not be told that hallucinogens had been administered.⁶⁵

The CIA's project involving the surreptitious administration of LSD to unwitting human subjects in the United States was finally halted in 1963, as a result of its discovery during the course of an Inspector General survey of the Technical Services Division. When the Inspector General learned of the project, he spoke to the Deputy Director for Plans, who agreed that the Director should be briefed. The DDP made it clear that the DCI and his Deputy were generally familiar with MKULTRA. He indicated, however, that he was not sure it was necessary to brief the DDCI at that point.

On May 24, 1963, the DDP advised the Inspector General that he had briefed the Director on the MKULTRA program and in particular had covered the question of the surreptitious administration of LSD to unwitting human subjects. According to the Inspector General, the DDP said that "the Director indicated no disagreement and therefore the 'testing' will continue."⁶⁶

One copy of an "Eyes Only" draft report on MKULTRA was prepared by the Inspector General who recommended the termination of the surreptitious administration project. The project was suspended following the Inspector General's report.

On December 17, 1963, Deputy Director for Plans Helms wrote a memo to the DDCI, who with the Inspector General and the Executive Director-Comptroller had opposed the covert testing. He noted two aspects of the problem: (1) "for over a decade the Clandestine Services has had the mission of maintaining a capability for influencing human behavior;" and (2) "testing arrangements in furtherance of this mission should be as operationally realistic and yet as controllable as possible." Helms argued that the individuals must be "unwitting" as this was "the only realistic method of maintaining the capability, considering the intended operational use of materials to influence human behavior as the operational targets will certainly be unwitting. Should the subjects of the testing not be unwitting, the program would only be "pro forma" resulting in a "false sense of accomplishment and readiness."⁶⁷ Helms continued:

cian need not be present. There is no danger medically in the use of this material as handled by TSS trained personnel." The Office of Medical Services had taken the position that LSD was "medically dangerous." Both the Office of Security and the Office of Medical Services argued that LSD "should not be administered unless preceded by a medical examination . . . and should be administered only by or in the presence of a physician who had studied it and its effect." (Memorandum from James Angleton, Chief, Coanteriorintelligence Staff to Chief of Operations, 12/12/67, pp. 1-2.

* Physicians might be called with the hope that they would make a diagnosis of mental breakdown which would be useful in discrediting the individual who was the subject of the CIA interest.

⁶⁶ Memorandum for the Record prepared by the Inspector General, 5/15/63, p. 1.

⁶⁷ *Ibid.*, p. 2.

If one grants the validity of the mission of maintaining this unusual capability and the necessity for unwitting testing, there is only then the question of how best to do it. Obviously, the testing should be conducted in such a manner as to permit the opportunity to observe the results of the administration on the target. It also goes without saying that whatever testing arrangement we adopt must afford maximum safeguards for the protection of the Agency's role in this activity, as well as minimizing the possibility of physical or emotional damage to the individual tested.⁶⁸

In another memo to the Director of Central Intelligence in June, 1964, Helms again raised the issue of unwitting testing. At that time General Carter, then acting DCI, approved several changes in the MKULTRA program proposed by Mr. Helms as a result of negotiations between the Inspector General and the DDP. In a handwritten note, however, Director Carter added that "unwitting testing will be subject to a separate decision."⁶⁹

No specific decision was made then or soon after. The testing had been halted and, according to Walter Elder, Executive Assistant to DCI McCone, the DCI was not inclined to take the positive step of authorizing a resumption of the testing. At least through the summer, the DDP did not press the issue. On November 9, 1964, the DDP raised the issue again in a memo to the DCI, calling the Director's attention to what he described as "several other indications during the past year of an apparent Soviet aggressiveness in the field of covertly administered chemicals which are, to say the least, inexplicable and disturbing."⁷⁰

Helms noted that because of the suspension of covert testing, the Agency's "positive operational capability to use drugs is diminishing, owing to a lack of realistic testing. With increasing knowledge of the state of the art, we are less capable of staying up with Soviet advances in this field. This in turn results in a waning capability on our part to restrain others in the intelligence community (such as the Department of Defense) from pursuing operations in this area."⁷¹

Helms attributed the cessation of the unwitting testing to the high risk of embarrassment to the Agency as well as the "moral problem." He noted that no better covert situation had been devised than that which had been used, and that "we have no answer to the moral issue."⁷²

Helms asked for either resumption of the testing project or its definitive cancellation. He argued that the status quo of a research and development program without a realistic testing program was causing the Agency to live "with the illusion of a capability which is becoming minimal and furthermore is expensive."⁷³ Once again no formal action was taken in response to the Helms' request.

⁶⁸ Memorandum from DDP Helms to DDCI Carter, 12/17/63.

⁶⁹ Memorandum from DDP Helms to DCI, 6/9/64, p. 3.

⁷⁰ *Ibid.*, 11/9/64, p. 1.

⁷¹ *Ibid.*, pp. 1-2.

⁷² *Ibid.*, p. 2.

⁷³ *Ibid.*

From its beginning in the early 1950's until its termination in 1963, the program of surreptitious administration of LSD to unwitting non-volunteer human subjects demonstrates a failure of the CIA's leadership to pay adequate attention to the rights of individuals and to provide effective guidance to CIA employees. Though it was known that the testing was dangerous, the lives of subjects were placed in jeopardy and their rights were ignored during the ten years of testing which followed Dr. Olson's death. Although it was clear that the laws of the United States were being violated, the testing continued. While the individuals involved in the Olson experiment were admonished by the Director, at the same time they were also told that they were not being reprimanded and that their "bad judgment" would not be made part of their personnel records. When the covert testing project was terminated in 1963, none of the individuals involved were subject to any disciplinary action.

4. *Monitoring and Control of the Testing and Use of Chemical and Biological Agents by the CIA*

The Select Committee found numerous failures in the monitoring and control of the testing and use of chemical and biological agents within the CIA.⁷⁴ An analysis of the failures can be divided into four sections: (a) the waiver of normal regulations or requirements; (b) the problems in authorization procedures; (c) the failure of internal review mechanisms such as the Office of General Counsel, the Inspector General, and the Audit Staff; and (d) the effect of compartmentation and competition within the CIA.

a. The Waiver of Administrative Controls.—The internal controls within any agency rest on: (1) clear and coherent regulations; (2) clear lines of authority; and (3) clear rewards for those who conduct themselves in accord with agency regulations and understandable and immediate sanctions against those who do not. In the case of the testing and use of chemical and biological agents, normal CIA administrative controls were waived. The destruction of the documents on the largest CIA program in this area constituted a prominent example of the waiver of normal Agency procedures by the Director.

These documents were destroyed in early 1973 at the order of then DCI Richard Helms. According to Helms, Dr. Sidney Gottlieb, then Director of TSD:

... came to me and said that he was retiring and that I was retiring and he thought it would be a good idea if these files were destroyed. And I also believe part of the reason for our thinking this was advisable was there had been relationships with outsiders in government agencies and other organizations and that these would be sensitive in this kind of a thing but that since the program was over and finished and done with, we thought we would just get rid of the files as

⁷⁴ Section 2(9) of S. Res. 21 instructs the Committee to examine: the "extent to which United States intelligence agencies are governed by Executive Orders, rules, or regulations either published or secret."

well, so that anybody who assisted us in the past would not be subject to follow-up or questions, embarrassment, if you will.⁷⁵

The destruction was based on a waiver of an internal CIA regulation, CSI 70-10, which regulated the "retirement of inactive records." As Thomas Karamessines, then Deputy Director of Plans, wrote in regulation CSI-70-10: "Retirement is not a matter of convenience or of storage but of conscious judgment in the application of the rules modified by knowledge of individual component needs. The heart of this judgment is to ensure that the complete story can be reconstructed in later years and by people who may be unfamiliar with the events."⁷⁶

The destruction of the MKULTRA documents made it impossible for the Select Committee to determine the full range and extent of the largest CIA research program involving chemical and biological agents. The destruction also prevented the CIA from locating and providing medical assistance to the individuals who were subjects in the program. Finally, it prevented the Committee from determining the full extent of the operations which made use of materials developed in the MKULTRA program.⁷⁷

From the inception of MKULTRA normal Agency procedures were waived. In 1953, Mr. Helms, then Assistant Deputy Director for Plans, proposed the establishment of MKULTRA. Under the proposal six percent of the research and development budget of TSD would be expended "without the establishment of formal contractual relations" because contracts would reveal government interest. Helms also voted that qualified individuals in the field "are most reluctant to enter into signed agreements of any sort which connect them with this activity since such a connection would jeopardize their professional reputa-

⁷⁵ Richard Helms testimony, 9/11/75, p. 5.

Many Agency documents recording confidential relationships with individuals and organizations are retained without public disclosure. Moreover, in the case of MKULTRA the CIA had spent millions of dollars developing both materials and delivery systems which could be used by the Clandestine Services; the reconstruction of the research and development program would be difficult if not impossible, without the documents, and at least one assistant to Dr. Gottlieb protested against the document destruction on those grounds.

⁷⁶ Clandestine Services Institution (CSI) 70-10. When asked by the Select Committee about the regularity of the procedure by which he authorized Dr. Gottlieb to destroy the MKULTRA records, Helms responded:

"Well, that's hard to say whether it would be part of the regular procedure or not, because the record destruction program is conducted according to a certain pattern. There's a regular record destruction pattern in the Agency monitored by certain people and done a certain way. So that anything outside of that, I suppose, would have been unusual. In other words, there were documents being destroyed because somebody had raised this specific issue rather than because they were encompassed in the regular records destruction program. So I think the answer to your question is probably yes." (Helms testimony, 9/11/75, p. 6.)

⁷⁷ Even prior to the destruction of documents, the MKULTRA records were far from complete. As the Inspector General noted in 1963:

"Files are notably incomplete, poorly organized, and lacking in evaluative statements that might give perspective to management policies over time. A substantial portion of the MKULTRA record appears to rest in the memories of the principal officers and is therefore almost certain to be lost with their departures." (IG Report on MKULTRA, p. 23.)

tions".⁷⁸ Other Agency procedures, i.e., the forwarding of documents in support of invoices and the provision for regular audit procedures, were also to be waived. On April 13, 1953, then DCI Allen Dulles approved MKULTRA, noting that security considerations precluded handling the project through usual contractual agreements.

Ten years later investigations of MKULTRA by both the Inspector General and the Audit Staff noted substantial deficiencies which resulted from the waivers. Because TSD had not reserved the right to audit the books of contractors in MKULTRA, the CIA had been unable to verify the use of Agency grants by a contractor. Another firm had failed to establish controls and safeguards which would assure "proper accountability" in use of government funds with the result that "funds have been used for purposes not contemplated by grants or allowable under usual contract relationship."⁷⁹ The entire MKULTRA arrangement was condemned for having administrative lines which were unclear, overly permissive controls, and irresponsible supervision.

The head of the Audit Branch noted that inspections and audits: led us to see MKULTRA as frequently having provided a device to escape normal administrative controls for research that is not especially sensitive, as having allowed practices that produce gross administrative failures, as having permitted the establishment of special relationships with unreliable organizations on an unacceptable basis, and as having produced, on at least one occasion, a cavalier treatment of a bona fide contracting organization.

While admitting that there may be a need for special mechanisms for handling sensitive projects, the Chief of the Audit Branch wrote that "both the terms of reference and the ground rules for handling such special projects should be spelled out in advance so that diversion from normal channels does not mean abandonment of controls.

Special procedures may be necessary to ensure the security of highly sensitive operations. To prevent the erosion of normal internal control mechanisms, such waivers should not be extended to less sensitive operations. Moreover, only those regulations which would endanger security should be waived; to waive regulations generally would result in highly sensitive and controversial projects having looser rather than stricter administrative controls. MKNAOMI, the Fort Detrick CIA project for research and development of chemical and biological agents, provides another example where efforts to protect the security of agency activities overwhelmed administrative controls. No written records of the transfer of agents such as anthrax or shellfish toxin were kept, "because of the sensitivity of the area and the desire to keep any possible use of materials like this recordless."⁸¹ The

⁷⁸ Memorandum from ADDP Helms to DCI Dulles, 4/3/53, Tab. A, p. 2.

⁷⁹ Memorandum from IG to Chief, TSD, 11/8/63, as quoted in memorandum from Chief, Audit Branch.

⁸⁰ The memorandum suggested that administrative exclusions, because of the importance of such decisions, should require the personal approval of the Deputy Director of Central Intelligence on an individual case basis. Present CIA policy is that only the DCI can authorize certain exemptions from regulations.

⁸¹ Sidney Gottlieb testimony, 10/18/75, Hearings, Vol. 1, p. 51.

result was that the Agency had no way of determining what materials were on hand, and could not be certain whether delivery systems such as dart guns, or deadly substances such as cobra venom had been issued to the field.

b. Authorization.—The destruction of the documents regarding MKULTRA made it difficult to determine at what level specific projects in the program were authorized. This problem is not solely a result of the document destruction, however. Even at the height of MKULTRA the IG noted that, at least with respect to the surreptitious administration of LSD, the "present practice is to maintain no records of the planning and approval of test programs."⁸²

While it is clear that Allen Dulles authorized MKULTRA, the record is unclear as to who authorized specific projects such as that involving the surreptitious administration of LSD to unwitting non-volunteer human subjects. Even given the sensitive and controversial nature of the project, there is no evidence that when John McCone replaced Allen Dulles as the Director of the Central Intelligence Agency he was briefed on the details of this project and asked whether it should be continued.⁸³ Even during the 1963 discussions on the propriety of unwitting testing, the DDP questioned whether it was "necessary to brief General Carter," the Deputy Director of Central Intelligence and the Director's "alter ego," because CIA officers felt it necessary to keep details of the project restricted to an absolute minimum number of people.⁸⁴

In May of 1963, DDP Helms told the Inspector General that the covert testing program was authorized because he had gone to the Director, briefed him on it and "the Director indicated no disagreement and therefore the testing will continue."⁸⁵ Such authorization even for noncontroversial matters is clearly less desirable than explicit authorization; in areas such as the surreptitious administration of drugs, it is particularly undesirable. Yet according to testimony

⁸² IG Report on MKULTRA, 1968, p. 14.

⁸³ According to an assistant to Dr. Gottlieb, there were annual briefings of the DCI and the DDP on MKULTRA by the Chief of TSD or his deputy. However, a May 15, 1968 Memorandum for the Record from the Inspector General noted that Mr. McCone had not been briefed in detail about the program. Mr. McCone's Executive Officer, Walter Elder, testified that it was "perfectly apparent to me" that neither Mr. McCone nor General Carter, then the DDCI, was aware of the surreptitious administration project "or if they had been briefed they had not understood it." (Elder, 12/18/75, p. 18.) Mr. McCone testified that he "did not know" whether he talked to anyone about the project but that no one had told him about it in a way that "would have turned on all the lights." (John McCone testimony, 2/3/76, p. 10.)

⁸⁴ According to Elder's testimony, "no Deputy Director, to my knowledge, has ever been briefed or was it ever thought necessary to brief them to the extent to which you would brief the Director."

⁸⁵ IG Memorandum for the Record, 5/15/63.

On the question of authorization of the covert testing program, Elder testified as follows:

"But my reasonable judgment is that this was considered to be in the area of continuing approval, having once been approved by the Director."

The theory of authorization carrying over from one administration to the next seems particularly inappropriate for less visible, highly sensitive operations which, unless brought to his attention by subordinates, would not come to the attention of the Director.

before the Committee, authorization through lack of agreement is even more prevalent in sensitive situations.⁸⁶

The unauthorized retention of shellfish toxin by Dr. Nathan Gordon and his subordinates, in violation of a Presidential Directive, may have resulted from the failure of the Director to issue written instructions to Agency officials. The retention was not authorized by senior officials in the Agency. The Director, Mr. Helms, had instructed Mr. Karamessines, the Deputy Director of Plans, and Dr. Gottlieb, the Chief of Technical Services Division, to relinquish control to the Army of any chemical or biological agents being retained for the CIA at Fort Detrick. Dr. Gottlieb passed this instruction on to Dr. Gordon. While orders may be disregarded in any organization, one of the reasons that Dr. Gordon used to defend the retention was the fact that he had not received written instructions forbidding it.⁸⁷

In some situations the existence of written instructions did not prevent unauthorized actions. According to an investigation by the CIA's Inspector General TSD officers had been *informed orally that Mr. Helms* was to be "advised at all times" when LSD was to be used. In addition TSD had received a memo advising the staff that LSD was not to be used without the permission of the DDP, Frank Wisner. The experiment involving Dr. Olson went ahead without notification of either Mr. Wisner or Mr. Helms. The absence of clear and immediate punishment for that act must undercut the force of other internal instructions and regulations.

One last issue must be raised about authorization procedures within the Agency. Chemical agents were used abroad until 1959 for discrediting or disabling operations, or for the purpose of interrogations with the approval of the Chief of Operations of the DDP. Later the approval of the Deputy Director for Plans was required for such operations. Although the medical staff sought to be part of the approval process for these operations, they were excluded because, as the Inspector General wrote in 1957:

Operational determinations are the responsibility of the DD/P and it is he who should advise the DCI in these respects, just as it is he who is responsible for the results. It is completely unrealistic to consider assigning to the Chief, Medical Staff, (what, in effect, would be authority over clandestine operations.)⁸⁸

Given the expertise and training of physicians, participation of the Medical Staff might well have been useful.

Questions about authorization also exist in regard to those agencies which assisted the CIA. For instance, the project involving the surreptitious administration of LSD to unwitting non-volunteer human subjects was conducted in coordination with the Bureau of Narcotics and Dangerous Drugs. There is some question as to the Commissioner of Narcotics' knowledge about the project.

⁸⁶ Mr. Elder was asked whether the process of bringing forward a description of actions by the Agency in getting approval through the absence of disagreement was a common one. He responded, "It was not uncommon. . . . The more sensitive the project the more likely it would lean toward being a common practice, based on the need to keep the written record to a minimum."

⁸⁷ Nathan Gordon testimony, 9/16/75, Hearings, Vol. 1.

⁸⁸ 1957 IG Report.

In 1963, the Inspector General noted that the head of the BNDD had been briefed about the project, but the IG's report did not indicate the level of detail provided to him. Dr. Gottlieb testified that "I remember meeting Mr. Anslinger and had the general feeling that he was aware."⁸⁹ Another CIA officer did not recall any discussion of testing on unwitting subjects when he and Dr. Gottlieb met with Commissioner Anslinger.

In a memorandum for the record in 1967 Dr. Gottlieb stated that Harry Giordano, who replaced Mr. Anslinger, told Dr. Gottlieb that when he became Commissioner he was "only generally briefed on the arrangements, gave it his general blessing, and said he didn't want to know the details." The same memorandum states, however, that there were several comments which indicated to Dr. Gottlieb that Mr. Giordano was aware of the substance of the project. It is possible that the Commissioner provided a general authorization for the arrangement without understanding what it entailed or considering its propriety. A reluctance to seek detailed information from the CIA, and the CIA's hesitancy to volunteer it, has been found in a number of instances during the Select Committee's investigations. This problem is not confined to the executive branch but has also marked congressional relationships with the Agency.

c. Internal Review.—The waiver of regulations and the absence of documentation make it difficult to determine now who authorized which activities. More importantly, they made internal Agency review mechanisms much less effective.⁹⁰ Controversial and highly sensitive projects which should have been subject to the most rigorous inspection lacked effective internal review.

Given the role of the General Counsel and his reaction to the surreptitious administration of LSD to Dr. Olson, it would have seemed likely that he would be asked about the legality or propriety of any subsequent projects involving such administration. This was not done. He did not learn about this testing until the 1970's. Nor was the General Counsel's opinion sought on other MKULTRA projects, though these had been characterized by the Inspector General in the 1957 Report on TSD as "unethical and illicit."⁹¹

There is no mention in the report of the 1957 Inspector General's survey of TSD of the project involving the surreptitious administration of LSD. That project was apparently not brought to the attention of the survey team. The Inspector who discovered it during the IG's 1963 survey of TSD recalls coming upon evidence of it inadvertently,

⁸⁹ Gottlieb, 10/18/75, p. 28.

⁹⁰ The IG's report on MKULTRA in 1963 stated:

"The original charter documents specified that TSD maintain exacting control of MKULTRA activities. In so doing, however, TSD has pursued a philosophy of minimum documentation in keeping with the high sensitivity of some of the projects. Some files were found to present a reasonably complete record, including most sensitive matters, while others with parallel objectives contained little or no data at all. The lack of consistent records precluded use of routine inspection procedures and raised a variety of questions concerning management and fiscal controls."

⁹¹ CIA, Inspector General's report on TSD, 1957, p. 217.

rather than its having been called to his attention as an especially sensitive project.⁹²

Thus both the General Counsel and the Inspector General, the principal internal mechanisms for the control of possibly improper actions, were excluded from regular reviews of the project. When the project was discovered the Executive Director-Comptroller voiced strong opposition to it; it is possible that the project would have been terminated in 1957 if it had been called to his attention when he then served as Inspector General.

The Audit Staff, which also serves an internal review function through the examination of Agency expenditures, also encountered substantial difficulty with MKULTRA. When MKULTRA was first proposed the Audit Staff was to be excluded from any function. This was soon changed. However, the waiver of normal "contractual procedures" in MKULTRA increased the likelihood of "irregularities" as well as the difficulty in detecting them. The head of the Audit Branch characterized the MKULTRA procedures as "having allowed practices that produced gross administrative failures," including a lack of controls within outside contractors which would "assure proper accountability in use of government funds." It also diminished the CIA's capacity to verify the accountings provided by outside firms.

d. Compartmentation and Jurisdictional Conflict Within the Agency.—As has been noted, the testing and use of chemical and biological agents was treated as a highly sensitive activity within the CIA. This resulted in a high degree of compartmentation. At the same time substantial jurisdictional conflict existed within the Agency between the Technical Services Division, and the Office of Medical Services and the Office of Security.

This compartmentation and jurisdictional conflict may well have led to duplication of effort within the CIA and to Agency policymakers being deprived of useful information.

During the early 1950's first the BLUEBIRD Committee and then the ARTICHOKE Committee were instituted to bring together representatives of the Agency components which had a legitimate interest in the area of the alteration of human behavior. By 1957 both these committees had fallen into disuse. No information went to the Technical Services Division (a component supposedly represented on the ARTICHOKE Committee) about ARTICHOKE operations being conducted by the Office of Security and the Office of Medical Services. The Technical Services Division which was providing support to the Clandestine Services in the use of chemical and biological agents, but provided little or no information to either the Office of Security or the Office of Medical Services. As one TSD officer involved in these programs testified: "Although we were acquainted, we certainly didn't share experiences."⁹³

⁹² Even after the Inspector came upon it the IG did not perform a complete investigation of it. It was discovered at the end of an extensive survey of TSD and the Inspector was in the process of being transferred to another post within the Agency.

⁹³ Testimony of CIA officer, 11/21/76, p. 14.

QKHILLTOP, another group designed to coordinate research in this area also had little success. The group met infrequently—only twice a year—and little specific information was exchanged.⁹⁴

Concern over security obviously played some role in the failure to share information,⁹⁵ but this appears not to be the only reason. A TSD officer stated that the Office of Medical Services simply wasn't "particularly interested in what we were doing" and never sought such information.⁹⁶ On the other hand, a representative of the Office of Medical Services consistently sought to have medical personnel participate in the use of chemical and biological agents suggested that TSD did not inform the Office of Medical Services in order to prevent their involvement.

Jurisdictional conflict was constant in this area. The Office of Security, which had been assigned responsibility for direction of ARTICHOKE, consistently sought to bring TSD operations involving psychochemicals under the ARTICHOKE umbrella. The Office of Medical Services sought to have OMS physicians advise and participate in the operational use of drugs. As the Inspector General described it in 1957, "the basic issue is concerned with the extent of authority that should be exercised by the Chief, Medical Staff, over the activities of TSD which encroach upon or enter into the medical field," and which are conducted by TSD "without seeking the prior approval of the Chief, Medical Staff, and often without informing him of their nature and extent."⁹⁷

As was noted previously, because the projects and programs of TSD stemmed directly from operational needs controlled by the DDP, the IG recommended no further supervision of these activities by the Medical Staff:

It is completely unrealistic to consider assigning to the Chief, Medical Staff, what, in effect, would be authority over clandestine operations. *Furthermore, some of the activities of Chemical Division are not only unorthodox but unethical and sometimes illegal. The DDP is in a better position to evaluate the justification for such operations than the Chief, Medical Staff.*⁹⁸ [Emphasis added.]

Because the advice of the Director of Security was needed for "evaluating the risks involved" in the programs and because the knowledge that the CIA was "engaging in unethical and illicit activities would have serious repercussions in political and diplomatic circles," the IG recommended that the Director of Security be fully advised of TSD's activities in these areas.

Even after the Inspector General's Report of 1957, the compartmentation and jurisdictional conflict continued. They may have had a sub-

⁹⁴ The one set of minutes from a QKHILLTOP meeting indicated that individuals in the Office of Medical Services stressed the need for more contact.

⁹⁵ When asked why information on the surreptitious administration of LSD was not presented to the ARTICHOKE committee, Dr. Gottlieb responded: "I imagine the only reason would have been a concern for broadening the awareness of its existence."

⁹⁶ CIA officer, 11/21/75, p. 14.

⁹⁷ IG Survey of TSD, 1957, p. 217.

⁹⁸ *Ibid.*

stantial negative impact on policymaking in the Agency. As the Deputy Chief of the Counterintelligence Staff noted in 1958, due to the different positions taken by TSS, the Office of Security, and the Office of Medical Services on the use of chemical or biological agents, it was possible that the individual who authorized the use of a chemical or biological agent could be presented with "incomplete facts upon which to make a decision relevant to its use." Even a committee set up by the DDP in 1958 to attempt to rationalize Agency policy did not have access to records of testing and use. This was due, in part, to excessive compartmentation, and jurisdictional conflict.

C. COVERT TESTING ON HUMAN SUBJECTS BY MILITARY INTELLIGENCE GROUPS: MATERIAL TESTING PROGRAM EA 1729, PROJECT THIRD CHANGE, AND PROJECT DERBY HAT

EA 1729 is the designator used in the Army drug testing program for lysergic acid diethylamide (LSD). Interest in LSD was originally aroused at the Army's Chemical Warfare Laboratories by open literature on the unusual effects of the compound.⁹⁹ The positive intelligence and counterintelligence potential envisioned for compounds like LSD, and suspected Soviet interest in such materials,¹⁰⁰ supported the development of an American military capability and resulted in experiments conducted jointly by the U.S. Army Intelligence Board and the Chemical Warfare Laboratories.

These experiments, designed to evaluate potential intelligence uses of LSD, were known collectively as "Material Testing Program EA 1729." Two projects of particular interest conducted as part of these experiments, "THIRD CHANCE" and "DERBY HAT", involved the administration of LSD to unwitting subjects in Europe and the Far East.

In many respects, the Army's testing programs duplicated research which had already been conducted by the CIA. They certainly involved the risks inherent in the early phases of drug testing. In the Army's tests, as with those of the CIA, individual rights were also subordinated to national security considerations; informed consent and follow-up examinations of subjects were neglected in efforts to maintain the secrecy of the tests. Finally, the command and control problems which were apparent in the CIA's programs are paralleled by a lack of clear authorization, and supervision in the Army's programs.

⁹⁹ USAINTC staff study, "Material Testing Program, EA 1729," 10/15/59, p. 4.

¹⁰⁰ This same USAINTC study cited "A 1952 (several years prior to initial U.S. interest in LSD-25) report that the Soviets purchased a large quantity of LSD-2 from the Sandoz Company in 1951, reputed to be sufficient for 50 million doses." (*Ibid.*, p. 16.)

Generally accepted Soviet methods and counterintelligence concerns were also strong motivating factors in the initiation of this research:

"A primary justification for field experimentation in intelligence with EA 1729 is the counter-intelligence or defense implication. We know that the enemy philosophy endorses any kind of coercion or violence for intelligence purposes. There is proof that his intelligence service has used drugs in the past. There is strong evidence of keen interest in EA 1729 by him. If for no other purpose than to know what to expect from enemy intelligence use of the material and to, thus, be prepared to counter it, field experimentation is justified." (*Ibid.*, p. 34)

1. Scope of Testing

Between 1955 and 1958 research was initiated by the Army Chemical Corps to evaluate the potential for LSD as a chemical warfare incapacitating agent. In the course of this research, LSD was administered to more than 1,000 American volunteers who then participated in a series of tests designed to ascertain the effects of the drug on their ability to function as soldiers. With the exception of one set of tests at Fort Bragg, these and subsequent laboratory experiments to evaluate chemical warfare potential were conducted at the Army Chemical Warfare Laboratories, Edgewood, Maryland.

In 1958 a new series of laboratory tests were initiated at Edgewood. These experiments were conducted as the initial phase of Material Testing Program EA 1729 to evaluate the intelligence potential of LSD, and included LSD tests on 95 volunteers.¹⁰¹ As part of these tests, three structured experiments were conducted:

1. LSD was administered surreptitiously at a simulated social reception to volunteer subjects who were unaware of the purpose or nature of the tests in which they were participating;
2. LSD was administered to volunteers who were subsequently polygraphed; and
3. LSD was administered to volunteers who were then confined to "isolation chambers".

These structured experiments were designed to evaluate the validity of the traditional security training all subjects had undergone in the face of unconventional, drug enhanced, interrogations.

At the conclusion of the laboratory test phase of Material Testing Program EA 1729 in 1960, the Army Assistant Chief of Staff for Intelligence (ACSI) authorized operational field testing of LSD. The first field tests were conducted in Europe by an Army Special Purpose Team (SPT) during the period from May to August of 1961. These tests were known as Project THIRD CHANCE and involved eleven separate interrogations of ten subjects. None of the subjects were volunteers and none were aware that they were to receive LSD. All but one subject, a U.S. soldier implicated in the theft of classified documents, were alleged to be foreign intelligence sources or agents. While interrogations of these individuals were only moderately successful, at least one subject (the U.S. soldier) exhibited symptoms of severe paranoia while under the influence of the drug.

The second series of field tests, Project DERBY HAT, were conducted by an Army SPT in the Far East during the period from August to November of 1962. Seven subjects were interrogated under DERBY HAT, all of whom were foreign nationals either suspected of dealing in narcotics or implicated in foreign intelligence operations. The purpose of this second set of experiments was to collect additional data on the utility of LSD in field interrogations, and to evaluate any different effects the drug might have on "Orientals."

¹⁰¹ Inspector General of the Army Report, "Use of Volunteers in Chemical Agent Research," 3/10/70, p. 138.

2. Inadequate Coordination Among Intelligence Agencies

On October 15, 1959, the U.S. Army Intelligence Center prepared lengthy staff study on Material Testing Program EA 1729. The stated purpose of the staff study was: "to determine the desirability of EA 1729 on non-US subjects in selected actual operations under controlled conditions.¹⁰² It was on the basis of this study that operational field tests were later conducted.

After noting that the Chemical Warfare Laboratories began experiments with LSD on humans in 1955 and had administered the drug to over 1,000 volunteers, the "background" section of the study concluded:

There has not been a single case of residual ill effect. Study of the prolific scientific literature on LSD-25 and personal communication between US Army Chemical Corps personnel and other researchers in this field have failed to disclose an authenticated instance of irreversible change being produced in normal humans by the drug.¹⁰³

This conclusion was reached despite an awareness that there were inherent medical dangers in such experimentation. In the body of this same study it is noted that:

The view has been expressed that EA 1729 is a potentially dangerous drug, whose pharmaceutical actions are not fully understood and there has been cited the possibility of the continuance of a chemically induced psychosis in chronic form, particularly if a latent schizophrenic were a subject, with consequent claim or representation against the U.S. Government.¹⁰⁴

An attempt was made to minimize potential medical hazards by careful selection of subjects prior to field tests. Rejecting evidence that the drug might be hazardous, the study continued:

The claim of possible permanent damage caused by EA 1729 is an unproven hypothesis based on the characteristic effect of the material. While the added stress of a real situation may increase the probability of permanent adverse effect, *the resulting risk is deemed to be slight by the medical research personnel of the Chemical Warfare Laboratories.* To prevent even such a slight risk, the proposed plan for field experimentation calls for overt, if possible, or contrived-through-ruse, if necessary, physical and mental examination of any real situation subject prior to employment of the subject.¹⁰⁵

This conclusion was drawn six years after one death had occurred which could be attributed, at least in part, to the effects of the very drug the Army was proposing to field test. The USAINTC staff, however, was apparently unaware of the circumstances surrounding Dr. Olson's death. This lack of knowledge is indicative of the

¹⁰² USAINTC staff study, "Material Testing Program EA-1729," 10/15/59, p. 4.

¹⁰³ *Ibid.*, p. 4.

¹⁰⁴ *Ibid.*, p. 25.

¹⁰⁵ *Ibid.*

general lack of interagency communication on drug related research. As the October 1959 study noted, "there has been no coordination with other intelligence agencies up to the present."¹⁰⁶

On December 7, 1959, the Army Assistant Chief of Staff for Intelligence (ACSI, apparently a General Willems) was briefed on the proposed operational use of LSD by USAINTC Project Officer Jacobson, in preparation for Project THIRD CHANCE. General Willems expressed concern that the project had not been coordinated with the FBI and the CIA. He is quoted as saying "that if this project is going to be worth anything it [LSD] should be used on higher types of non-U.S. subjects" in other words "staffers." He indicated this could be accomplished if the CIA were brought in. The summary of the briefing prepared by a Major Mehovsky continues: "Of particular note is that ACSI did not direct coordination with CIA and the FBI but only mentioned it for consideration by the planners."¹⁰⁷

After the briefing, four colonels, two lieutenant colonels and Major Mehovsky met to discuss interagency cooperation with CIA and FBI. The group consensus was to postpone efforts toward coordination:

Lt. Col. Jacobson commented that before we coordinate with CIA we should have more factual findings from field experimentation with counterintelligence cases that will strengthen our position and proposal for cooperation. This approach was agreed to by the conferees.¹⁰⁸

Had such coordination been achieved, the safety of these experiments might have been viewed differently and the tests themselves might have been seen as unnecessary.

3. Subordination of Individual Rights to National Security Considerations

Just as many of these experiments may have been unnecessary, the nature of the operational tests (polygraph-assisted interrogations of drugged suspects) reflects a basic disregard for the fundamental human rights of the subjects. The interrogation of an American soldier as part of the THIRD CHANCE 1961 tests is an example of this disregard.

The "trip report" for Project THIRD CHANCE, dated September 6, 1961, recounts the circumstances surrounding and the results of the tests as follows:

[The subject] was a U.S. soldier who had confessed to theft of classified documents. Conventional methods had failed to ascertain whether espionage intent was involved. A significant new admission by subject that he told a fellow soldier of the theft while he still had the documents in his possession was obtained during the EA 1729 interrogation along with other variations of Subject's previous account. The interrogation results were deemed by the local operational authority satisfactory evidence of Subject's claim of innocence in regard to espionage intent.¹⁰⁹

¹⁰⁶ *Ibid.*, p. 6.

¹⁰⁷ Mehovsky Fact Sheet, 12/0/60, p. 1.

¹⁰⁸ *Ibid.*, p. 2.

¹⁰⁹ SPT Trip Report, Operation THIRD CHANCE, 9/6/61, p. 5.

The subject apparently reacted very strongly to the drug, and the interrogation, while productive, was difficult. The trip report concluded:

(1) This case demonstrated the ability to interrogate a subject profitably throughout a highly sustained and almost incapacitating reaction to EA 1729.

(2) The apparent value of bringing a subject into the EA 1729 situation in a highly stressed state was indicated.

(3) The usefulness of employing as a duress factor the device of inviting the subject's attention to his EA 1729-influenced state and threatening to extend this state indefinitely even to a permanent condition of insanity, or to bring it to an end at the discretion of the interrogators was shown to be effective.

(4) The need for preplanned precautions against extreme paranoiac reaction to EA 1729 was indicated.

(5) It was brought to attention by this case that where subject has undergone extended intensive interrogation prior to the EA 1729 episode and has persisted in a version repeatedly during conventional interrogation, adherence to the same version while under EA 1729 influence, however extreme the reaction, may not necessarily be evidence of truth but merely the ability to adhere to a well rehearsed story.¹¹⁰

This strong reaction to the drug and the accompanying discomfort this individual suffered were exploited by the use of traditional interrogation techniques. While there is no evidence that physical violence or torture were employed in connection with this interrogation, physical and psychological techniques were used in the THIRD CHANCE experiments to exploit the subjects' altered mental state, and to minimize the stress situation. Jacobson described these methods in his trip report:

Stressing techniques employed included silent treatment before or after EA 1729 administration, sustained conventional interrogation prior to EA 1729 interrogation, deprivation of food, drink, sleep or bodily evacuation, sustained isolation prior to EA 1729 administration, hot-cold switches in approach, duress "pitches", verbal degradation and bodily discomfort, or dramatized threats to subject's life or mental health.¹¹¹

Another gross violation of an individual's fundamental rights occurred in September 1962 as part of the Army's DERBY HAT tests in the Far East. A suspected Asian espionage agent was given 6 micrograms of LSD per kilogram of bodyweight. The administration of the drug was completed at 1035 that morning:

At 1120, sweating became evident, his pulse became thready. He was placed in a supine position. He began groaning with expiration and became semicomatose.¹¹²

¹¹⁰ *Ibid.*, pp. 17-18.

¹¹¹ *Ibid.*, p. 13.

¹¹² "DERBY HAT" Medical and Pharmacological Report: Case #1, 9/20/62, p. D10-2.

For the next 28 minutes, the subject remained semicomatose.

At 1148, responses to painful stimuli were slightly improved.

At 1155, he was helped to a sitting position.

At 1200, he became shocky again and was returned to supine position.

At 1212, he was more alert and able to sit up with help.

At 1220, Subject was assisted to the interrogation table.

At 1230, he began moaning he wanted to die and usually ignored questions. Rarely he stated "he didn't know."

At 1250, his phasic alertness persisted. He frequently re-focused his eyes with eyelid assistance. He frequently threw his head back with eyes closed.

At 1330, he was slightly more alert. He was forced-walked for 5 minutes. He physically would cooperate until he became shocky again (sweating, thready pulse, pale).¹¹³

For the next three hours the subject remained in about the same condition. Continued attempts at interrogation yielded no relevant answers. Six hours after receiving the drug, the subject began giving relevant answers to questions. Eight and one-half hours after the initial dosage, the subject was polygraphed. The interrogation continued for seventeen and one-half hours after the drug was administered.

There was some psychological and medical screening of the individuals tested within the United States, in Europe, and in Asia. The proposal for the field experimentation in fact called for such examinations. The fact of prescreening did not eliminate the risk of injury; the availability of medical staff did, however, limit injury and may well have prevented the death of one or more of the subjects. As the medical corps member of the team which surreptitiously administered the LSD noted, "one subject . . . did collapse after the interrogation and the presence of the medical officer was not only of value to the subject but to the interrogation team who were thus assured that an unnecessary untoward result would not occur."¹¹⁴

In the October 15, 1959, USAINTC staff study, moral and legal ramifications of covert administration of LSD in field conditions were considered.

It was always a tenet of Army Intelligence that the basic American principle of the dignity and welfare of the individual will not be violated. . . . A more meticulous regard for the prohibition against violence or duress is taken in practice when the suspect is a US citizen or ally as against an actual or potential enemy, in peace as against war, and in respect to the nature of the crime. . . . In intelligence, the stakes involved and the interests of national security may permit a more tolerant interpretation of moral-ethical values, but not legal limits, through necessity. . . . Any claim

¹¹³ *Ibid.*, p. D10-3.

¹¹⁴ SPT Trip Report, Operation THIRD CHANCE, 7/25/61, p. 1.

against the US Government for alleged injury due to EA 1729 must be legally shown to have been due to the material. Proper security and appropriate operational techniques can protect the fact of employment of EA 1729.¹¹⁶

On the basis of this evaluation, the study concluded that in view of "the stakes involved and the interests of national security," the proposed plan for field testing should be approved.

The surreptitious administration of drugs to unwitting subjects by the Army raises serious constitutional and legal issues. The consideration given these issues by the Army was wholly insufficient. The character of the Army's volunteer testing program and the possibility that drugs were simply substituted for other forms of violence or duress in field interrogations raises serious doubts as to whether national security imperatives were properly interpreted. The "consent" forms which each American volunteer signed prior to the administration of LSD are a case in point. These forms contained no mention of the medical and psychological risks inherent in such testing, nor do they mention the nature of the psychotropic drug to be administered:

The general nature of the experiments in which I have volunteered have been explained to me from the standpoint of possible hazards to my health. *It is my understanding* that the experiments are so designed, based on the results of animals and previous human experimentation, *that the anticipated results will justify the performance of the experiment.* I understand further that experiments will be so conducted as to avoid all unnecessary physical and medical suffering and injury, and that *I will be at liberty to request that the experiments be terminated at any time* if in my opinion I have reached the physical or mental state where continuation of the experiments becomes undesirable.

I recognize that in the pursuit of certain experiments transitory discomfort may occur. I recognize, also, that under these circumstances, *I must rely upon the skill and wisdom of the physician supervising the experiment* to institute whatever medical or surgical measures are indicated. [Emphasis added.]¹¹⁸

The exclusion of any specific discussion of the nature of LSD in these forms raises serious doubts as to their validity. An "understanding . . . that the anticipated results will justify the performance of the experiment" without full knowledge of the nature of the experiment is an incomplete "understanding." Similarly, the nature of the experiment limited the ability of both the subject to request its request its termination and the experimenter to implement such a request. Finally, the euphemistic characterization of "transitory discomfort" and the agreement to "rely on the skill and wisdom of the physician" combine to conceal inherent risks in the experimentation and may be viewed as dissolving the experimenter of personal responsibility for damaging aftereffects. In summary, a "volunteer" program in which subjects are not fully informed of potential hazards to their persons is "volunteer" in name only.

¹¹⁶ USAINTC staff study, "Material Testing Program EA 1729," 10/15/59, p. 26.

¹¹⁷ Sample volunteer consent form.

This problem was compounded by the security statements signed by each volunteer before he participated in the testing. As part of this statement, potential subjects agreed that they would:

. . . not divulge or make available any information related to U.S. Army Intelligence Center interest or participation in the Department of the Army Medical Research Volunteer Program to any individual, nation, organization, business association, or other group or entity, not officially authorized to receive such information.

I understand that any action contrary to the provisions of this statement will render me liable to punishment under the provisions of the Uniform Code of Military Justice.¹¹⁹

Under these provisions, a volunteer experiencing aftereffects of the test might have been unable to seek immediate medical assistance.

This disregard for the well-being of subjects drug testing is inexcusable. Further, the absence of any comprehensive long-term medical assistance for the subjects of these experiments is not only unscientific; it is also unprofessional.

4. *Lack of Normal Authorization and Supervision*

It is apparent from documents supplied to the Committee that the Army's testing programs often operated under informal and nonroutine authorization. Potentially dangerous operations such as these testing programs are the very projects which ought to be subject to the closest internal scrutiny at the highest levels of the military command structure. There are numerous examples of inadequate review, partial consideration, and incomplete approval in the administration of these programs.

When the first Army program to use LSD on American soldiers in "field stations" was authorized in May 1955, the Army violated its own procedures in obtaining approval. Under Army Chief of Staff Memorandum 385, such proposals were to be personally approved by the Secretary of the Army. Although the plan was submitted to him on April 26, 1956, the Secretary issued no written authorization for the project, and there is no evidence that he either reviewed or approved the plan. Less than a month later, the Army Chief of Staff issued a memorandum authorizing the tests.¹²⁰

Subsequent testing of LSD under Material Testing Program EA 1729 operated generally under this authorization. When the plans for this testing were originally discussed in early 1958 by officials of the Army Intelligence Center at Fort Holabird and representatives of the Chemical Warfare Center at Edgewood Arsenal, an informal proposal was formulated. This proposal was submitted to the Medical Research Directorate at Edgewood by the President of the Army Intelligence Board on June 3, 1958. There is no evidence that the plan was approved at any level higher than the President of the Intelligence Board or the Commanding General of Edgewood. The approval at Edgewood appears to have been issued by the Commander's Adjutant. The Medical Research Laboratories did not submit the plan to the Surgeon General for approval (a standard procedure) because

¹¹⁹ Sample Volunteer Security Statement.

¹²⁰ Inspector General of the Army Report, "Use of Volunteers in Chemical Agent Research," 3/10/70, p. 109.

the new program was ostensibly covered by the authorizations granted in May 1956.¹²¹

The two projects involving the operational use of LSD (THIRD CHANCE and DERBY HAT) were apparently approved by the Army Assistant Chief of Staff for Intelligence (General Willems) on December 7, 1960.¹²² This verbal approval came in the course of a briefing on previous drug programs and on the planned field experimentation. There is no record of written approval being issued by the ACSI to authorize these specific projects until January 1961, and there is no record of any specific knowledge or approval by the Secretary of the Army.

On February 4, 1963, Major General C. F. Leonard, Army ACSI, forwarded a copy of the THIRD CHANCE Trip Report to Army Chief of Staff, General Earl Wheeler.¹²³ Wheeler had apparently requested a copy on February 2. The report was routed through a General Hamlett. While this report included background on the origins of the LSD tests, it appears that General Wheeler may only have read the conclusion and recommendations.¹²⁴ The office memorandum accompanying the Trip Report bears Wheeler's initials.¹²⁵

5. Termination of Testing

On April 10, 1963, a briefing was held in the ACSI's office on the results of Projects THIRD CHANCE and DERBY HAT. Both SPT's concluded that more field testing was required before LSD could be utilized as an integral aid to counterintelligence interrogations. During the presentation of the DERBY HAT results, General Leonard (Deputy ACSI) directed that no further field testing be undertaken.¹²⁶ After this meeting the ACSI sent a letter to the Commanding General of the Army Combat Developments Command (CDC) requesting that he review THIRD CHANCE and DERBY HAT and "make a net evaluation concerning the adoption of EA 1729 for future use as an effective and profitable aid in counterintelligence interrogations."¹²⁷ On the same day the ACSI requested that the CDC Commander revise regulation FM 30-17 to read in part:

. . . in no instance will drugs be used as an aid to interrogations in counterintelligence or security operations without prior permission of the Department of the Army. Requests to use drugs as an investigative aid will be forwarded through intelligence channels to the OACSI, DA, for approval. . . .

Medical research has established that information obtained through the use of these drugs is unreliable and invalid. . . .

It is considered that DA [Army] approval must be a prerequisite for use of such drugs because of the moral, legal, medical and political problems inherent in their use for intelligence purposes.¹²⁸

¹²¹ *Ibid.*, pp. 135, 137, 138.

¹²² Mehovsky Fact Sheet, 12/9/60.

¹²³ Memorandum from Leonard to Wheeler, 2/4/63.

¹²⁴ SGS memorandum to Wheeler through Hamlett, 2/5/63.

¹²⁵ *Ibid.*

¹²⁶ Maj. F. Barnett, memorandum for the record, 8/12/63.

¹²⁷ Yamaki memorandum for the record, 7/10/63.

¹²⁸ *Ibid.*

The subsequent adoption of this regulation marked the effective termination of field testing of LSD by the Army.

The official termination date of these testing programs is rather unclear, but a later ACSI memo indicates that it may have occurred in September of 1963. On the 19th of that month a meeting was held between Dr. Van Sims (Edgewood Arsenal), Major Clovis (Chemical Research Laboratory), and ACSI representatives (General Deholm and Colonel Schmidt). "As a result of this conference a determination was made to suspend the program and any further activity pending a more profitable and suitable use."¹²⁹

D. COOPERATION AND COMPETITION AMONG THE INTELLIGENCE COMMUNITY AGENCIES AND BETWEEN THESE AGENCIES AND OTHER INDIVIDUALS AND INSTITUTIONS

1. *Relationships Among Agencies Within the Intelligence Community*

Relationships among intelligence community agencies in this area varied considerably over time, ranging from full cooperation to intense and wasteful competition. The early period was marked by a high degree of cooperation among the agencies of the intelligence community. Although the military dominated research involving chemical and biological agents, the information developed was shared with the FBI and the CIA. But the spirit of cooperation did not continue. The failure by the military to share information apparently breached the spirit, if not the letter, of commands from above.

As noted above, the Army Assistant Chief of Staff for Intelligence was briefed on the proposed operational testing of LSD under Project THIRD CHANCE, and expressed concern that the project had not been coordinated with FBI and CIA. Despite this request, no coordination was achieved between the Army and either of these agencies. Had such cooperation been forthcoming, this project may have been evaluated in a different light.

The competition between the agencies in this area reached bizarre levels. A military officer told a CIA representative in confidence about the military's field testing of LSD in Europe under Project THIRD CHANCE, and the CIA promptly attempted to learn surreptitiously the nature and extent of the program. At roughly the same time Mr. Helms argued to the DDCI that the unwitting testing program should be continued, as it contributed to the CIA's capability in the area and thus allowed the CIA "to restrain others in the intelligence community (such as the Department of Defense) from pursuing operations."¹³⁰

The MKNAOMI program was also marked by a failure to share information. The Army Special Forces (the principal customer of the Special Operations Division at Fort Dietrick) and the CIA rather than attempting to coordinate their efforts promulgated different requirements which varied only slightly. This apparently resulted in some duplication of effort. In order to insure the security of CIA operations, the Agency would request materials from SOD for operational use without fully or accurately describing the operational requirements. This resulted in limitations on SOD's ability to assist the CIA.

¹²⁹ Undated ACSI memorandum, p. 2.

¹³⁰ Memorandum from the DDP to the DCI, 11/9/64, p. 2.

2. Relationships Between the Intelligence Community Agencies and Foreign Liaison Services

The subjects of the CIA's operational testing of chemical and biological agents abroad were generally being held for interrogation by foreign intelligence or security organizations. Although information about the use of drugs was generally withheld from these organizations, cooperation with them necessarily jeopardized the security of CIA interest in these materials. Cooperation also placed the American Government in a position of complicity in actions which violated the rights of the subjects, and which may have violated the laws of the country in which the experiments took place.

Cooperation between the intelligence agencies and organizations in foreign countries was not limited to relationships with the intelligence or internal security organizations. Some MKULTRA research was conducted abroad. While this is, in itself, not a questionable practice, it is important that such research abroad not be undertaken to evade American laws. That this was a possibility is suggested by an ARTICHOKE memorandum in which it is noted that working with the scientists of a foreign country "might be very advantageous" since that government "permitted certain activities which were not permitted by the United States government (i.e., experiments on anthrax, etc.)."¹³¹

3. The Relationships Between the Intelligence Community Agencies and Other Agencies of the U.S. Government

Certain U.S. government agencies actively assisted the effort of intelligence agencies in this area. One form of assistance was to provide "cover" for research contracts let by intelligence agencies, in order to disguise intelligence community interest in chemical and biological agents.

Other forms of assistance raise more serious questions. Although the CIA's project involving the surreptitious administration of LSD was conducted by Bureau of Narcotics personnel, there was no open connection between the Bureau personnel and the Agency. The Bureau was serving as a "cut-out" in order to make it difficult to trace Agency participation. The cut-out arrangement, however, reduced the CIA's ability to control the program. The Agency could not control the process by which subjects were selected and cultivated, and could not regulate follow-up after the testing. Moreover, as the CIA's Inspector General noted: "the handling of test subjects in the last analysis rests with the [Bureau of Narcotics] agent working alone. Suppression of knowledge of critical results from the top CIA management is an inherent risk in these operations."¹³² The arrangement also made it impossible for the Agency to be certain that the decision to end the surreptitious administration of LSD would be honored by the Bureau personnel.

The arrangement with the Bureau of Narcotics was described as "informal."¹³³ The informality of the arrangement compounded the problem is aggravated by the fact that the 40 Committee has had vir-

¹³¹ ARTICHOKE Memorandum, 6/13/52.

¹³² IG Report on MKULTRA, 1963, p. 14.

¹³³ *Ibid.* This was taken by one Agency official to mean that there would be no written contract and no formal mechanism for payment. (Elder, 12/18/75, p. 31.)

apparent unwillingness on the part of the Bureau's leadership to ask for details, and the CIA's hesitation in volunteering information. These problems raise serious questions of command and control within the Bureau.

4. Relationships Between the Intelligence Community Agencies and Other Institutions and Individuals, Public and Private

The Inspector General's 1963 Survey of MKULTRA noted that "the research and development" phase was conducted through standing arrangements with "specialists in universities, pharmaceutical houses, hospitals, state and federal institutions, and private research organizations" in a manner which concealed "from the institution the interests of the CIA." Only a few "key individuals" in each institution were "made witting of Agency sponsorship." The research and development phase was succeeded by a phase involving "physicians, toxicologists, and other specialists in mental, narcotics, and general hospitals and prisons, who are provided the products and findings of the basic research projects and proceed with intensive testing on human subjects."¹³⁴

According to the Inspector General, the MKULTRA testing programs were "conducted under accepted scientific procedures . . . where health permits, test subjects are voluntary participants in the programs."¹³⁵ This was clearly not true in the project involving the surreptitious administration of LSD, which was marked by a complete lack of screening, medical supervision, opportunity to observe, or medical or psychological follow-up.

The intelligence agencies allowed individual researchers to design their project. Experiments sponsored by these researchers (which included one where narcotics addicts were sent to Lexington, Kentucky, who were rewarded with the drug of their addiction in return for participation in experiments with LSD) call into question the decision by the agencies not to fix guidelines for the experiments.

The MKULTRA research and development program raises other questions, as well. It is not clear whether individuals in prisons, mental, narcotics and general hospitals can provide "informed consent" to participation in experiments such as these. There is doubt as to whether institutions should be unwitting of the ultimate sponsor of research being done in their facilities. The nature of the arrangements also made it impossible for the individuals who were not aware of the sponsor of the research to exercise any choice about their participation based on the sponsoring organization.

Although greater precautions are now being taken in research conducted on behalf of the intelligence community agencies, the dilemma of classification remains. These agencies obviously wished to conceal their interest in certain forms of research in order to avoid stimulating interest in the same areas by hostile governments. In some cases today contractors or researchers wish to conceal their connection with these agencies. Yet the fact of classification prevents open discussion and debate upon which scholarly work depends.

¹³⁴ *Ibid.*, p. 9.

¹³⁵ *Ibid.*, p. 10.

XVIII. SUMMARY: FINDINGS AND RECOMMENDATIONS

A. INTRODUCTION

The purpose of the Senate Select Committee's inquiry into the intelligence activities of the United States has been to determine what secret governmental activities are necessary and how they best can be conducted under the rule of law. There is unquestioned need to build a new consensus between the executive and legislative branches concerning the proper scope and purpose of foreign and military intelligence activities. Allegations of abuse, revelations in the press, and the results of the Committee's 15 month inquiry have underlined the necessity to restore confidence in the integrity of our nation's intelligence agencies.

The findings and recommendations which follow are presented in that spirit. They are, in essence, an agenda for remedial action by both the legislative and executive branches of the United States Government. There is an urgency to completing this schedule of action. This task is no less important to safeguarding America's future than are intelligence activities themselves.

The Committee's investigation and the body of its report seek, within the limits of prudence, to perform the crucial task of informing the American people concerning the nature and scope of their Government's foreign intelligence activities. The fundamental issue faced by the Committee in its investigation was how the requirements of American democracy can be properly balanced in intelligence matters against the need for secrecy. Secrecy is essential for the success of many important intelligence activities. At the same time, secrecy contributed to many of the abuses, excesses and inefficiencies uncovered by the Committee. Secrecy also makes it difficult to establish a public consensus for the future conduct of certain intelligence operations.

Because of secrecy, the Committee initially had difficulty gaining access to executive branch information required to carry out the investigation. It was not until the Committee became responsible for investigating allegations of assassination plots that many of the obstacles were cleared away. The resulting access by the Committee was in some cases unprecedented. But the Committee's access to documents and records was hampered nonetheless in a number of other instances either because the materials did not exist or because the executive branch was unwilling to make them available.

Secrecy was also a major issue in preparing this report. In order to safeguard what are now agreed to be necessary intelligence activities, the Committee decided not to reveal publicly the full and complete picture of the intelligence operations of the United States Government. The recommendations as a whole have not been materially affected by the requirements of secrecy, but some important findings of the Committee must remain classified in accordance with the Committee's policy of protecting valid secrets. In this connection it should be noted

that some information which in the Committee's opinion the American public should know remains classified and has been excluded from the report at the request of the intelligence community agencies. Only the Senate will receive the full version of the Committee's Final Report in accordance with the standing rules of the Senate.

In trying to reconcile the requirements of secrecy and open democratic processes, the Committee found itself with a difficult dilemma. As an investigating committee, it cannot take affirmative legislative action respecting some of the matters that came to its attention. On the other hand, because of necessary secrecy, the Committee cannot publicly present the full case as to why its recommendations are essential.

This experience underscores the need for an effective legislative oversight committee which has sufficient power to resolve such fundamental conflicts between secrecy and democracy. As stated previously, it is the Committee's view that effective congressional oversight requires the power to authorize the budgets of the national intelligence agencies. Without such authority, an oversight committee may find itself in possession of important secret information but unable to act effectively to protect the principles, integrity, and reputation of the United States.

The findings and recommendations which follow are organized principally by agency. There are, however, common themes in the recommendations which cut across agency lines. Some of these themes are: guarding against abuse of America's institutions and reputation; ensuring clear accountability for clandestine activities; establishing effective management of intelligence activities; and creating a framework of statutory law and congressional oversight for the agencies and activities of the United States intelligence community.

The Committee's recommendations fall into three categories: (1) recommendations that the Committee believes should be embodied in law; (2) recommendations to the executive branch concerning principles, practices, and policies which the Committee believes should be pursued within the executive's sphere of responsibilities; and (3) recommendations which should be taken into account by the executive branch in its relations with the intelligence oversight committee(s) of Congress.

B. GENERAL FINDINGS

The Committee finds that United States foreign and military intelligence agencies have made important contributions to the nation's security, and generally have performed their missions with dedication and distinction. The Committee further finds that the individual men and women serving America in difficult and dangerous intelligence assignments deserve the respect and gratitude of the nation.

The Committee finds that there is a continuing need for an effective system of foreign and military intelligence. United States interests and responsibilities in the world will be challenged, for the foreseeable future, by strong and potentially hostile powers. This requires the maintenance of an effective American intelligence system. The Committee has found that the Soviet KGB and other hostile intelligence services maintain extensive foreign intelligence operations, for both intelligence collection and covert operational purposes. These

activities pose a threat to the intelligence activities and interests of the United States and its allies.

The Committee finds that Congress has failed to provide the necessary statutory guidelines to ensure that intelligence agencies carry out their missions in accord with constitutional processes. Mechanisms for, and the practice of, congressional oversight have not been adequate. Further, Congress has not devised appropriate means to effectively use the valuable information developed by the intelligence agencies. Intelligence information and analysis that exist within the executive branch clearly would contribute to sound judgments and more effective legislation in the areas of foreign policy and national security.

The Committee finds that covert action operations have not been an exceptional instrument used only in rare instances when the vital interests of the United States have been at stake. On the contrary, presidents and administrations have made excessive, and at times self-defeating, use of covert action. In addition, covert action has become a routine program with a bureaucratic momentum of its own. The long-term impact, at home and abroad, of repeated disclosure of U.S. covert action never appears to have been assessed. The cumulative effect of covert actions has been increasingly costly to America's interests and reputation. The Committee believes that covert action must be employed only in the most extraordinary circumstances.

Although there is a question concerning the extent to which the Constitution requires publication of intelligence expenditures information, the Committee finds that the Constitution at least requires public disclosure and public authorization of an annual aggregate figure for United States national intelligence activities. Congress' failure as a whole to monitor the intelligence agencies' expenditures has been a major element in the ineffective legislative oversight of the intelligence community. The permanent intelligence oversight committee(s) of Congress should give further consideration to the question of the extent to which further public disclosure of intelligence budget information is prudent and constitutionally necessary.

At the same time, the Committee finds that the operation of an extensive and necessarily secret intelligence system places severe strains on the nation's constitutional government. The Committee is convinced, however, that the competing demands of secrecy and the requirements of the democratic process—our Constitution and our laws—can be reconciled. The need to protect secrets must be balanced with the assurance that secrecy is not used as a means to hide the abuse of power or the failures and mistakes of policy. Means must and can be provided for lawful disclosure of unneeded or unlawful secrets.

The Committee finds that intelligence activities should not be regarded as ends in themselves. Rather, the nation's intelligence functions should be organized and directed to assure that they serve the needs of those in the executive and legislative branches who have responsibility for formulating or carrying out foreign and national security policy.

The Committee finds that Congress has failed to provide the necessary statutory guidelines to ensure that intelligence agencies carry out their necessary missions in accord with constitutional processes.

In order to provide firm direction for the intelligence agencies, the Committee finds that new statutory charters for these agencies must be written that take account of the experience of the past three and a half decades. Further, the Committee finds that the relationship among the various intelligence agencies and between them and the Director of Central Intelligence should be restructured in order to achieve better accountability, coordination, and more efficient use of resources.

These tasks are urgent. They should be undertaken by the Congress in consultation with the executive branch in the coming year. The recent proposals and executive actions by the President are most welcome.¹ However, further action by Congress is necessary.

C. THE 1947 NATIONAL SECURITY ACT AND RELATED LEGISLATION

The National Security Act of 1947² is no longer an adequate framework for the conduct of America's intelligence activities. The 1947 Act, preoccupied as it was with the question of military unification, failed to provide an adequate statement of the broad policy and purposes to be served by America's intelligence effort. The Committee found that the 1947 Act constitutes a vague and open-ended statement of authority for the President through the National Security Council. Neither espionage, covert action, nor paramilitary warfare is explicitly authorized by the 1947 Act. Nonetheless, these have come to be major activities conducted by the Central Intelligence Agency, operating at the direction of the President through the National Security Council. In contrast, the 1947 Act's specific charge to the Director of Central Intelligence (DCI) to coordinate national intelligence has not been effectively realized.

In addition to this broad concern, the Committee found that the 1947 Act does not provide an adequate charter for the Central Intelligence Agency. Moreover, no statutory charter exists for other key intelligence agencies: the National Security Agency and the Defense Intelligence Agency. Nor does the Act create an overall structure for intelligence which ensures effective accountability, management control, and legislative and executive oversight.

Finally, the 1947 Act fails to establish clear and specific limits on the operation of America's intelligence organizations which will help ensure the protection of the rights and liberties of Americans under the Constitution and the preservation of America's honor and reputation abroad. The need for such limits is a need for legislation. The need is not satisfied by the President's recent proposals and Executive Order.

*Recommendations*³

1. The National Security Act should be recast by omnibus legislation which would set forth the basic purposes of national intelligence activities, and define the relationship between the Congress and the intelligence agencies of the executive branch. This revision should be given the highest priority by the intelligence oversight committee(s) of Congress, acting in consultation with the executive branch.

¹ Executive Order 11906, 2/18/76.

² 50 U.S.C. 401 *et seq.*

³ See recommendations on this subject in the Committee's Report on Intelligence Activities and Rights of Americans.

2. The new legislation should define the charter of the organizations and entities in the United States intelligence community. It should establish charters for the National Security Council, the Director of Central Intelligence, the Central Intelligence Agency, the national intelligence components of the Department of Defense, including the National Security Agency and the Defense Intelligence Agency, and all other elements of the intelligence community, including joint organizations of two or more agencies.

3. This legislation should set forth the general structure and procedures of the intelligence community, and the roles and responsibilities of the agencies which comprise it.

4. The legislation should contain specific and clearly defined prohibitions or limitations on various activities carried out by the respective components of the intelligence community.

D. THE NATIONAL SECURITY COUNCIL AND THE OFFICE OF THE PRESIDENT

The National Security Council (NSC) is an instrument of the President and not a corporate entity with authority of its own. The Committee found that in general the President has had, through the National Security Council, effective means for exerting broad policy control over at least two major clandestine activities—covert action⁴ and sensitive technical collection. The covert American involvement in Angola and the operations of the *Glomar Explorer* are examples of that control in quite different circumstances, whatever conclusions one draws about the merits of the activities. The Central Intelligence Agency, in broad terms, is not "out of control."

The Committee found, however, that there were significant limits to this control:

1. Clandestine Activities

—The degree of control and accountability exercised regarding covert action and sensitive collection has been a function of each particular President's willingness to use these techniques.

—The principal NSC vehicle for dealing with clandestine activities, the 40 Committee and its predecessors, was the mechanism for reviewing and making recommendations regarding the approval of major covert action projects. However, this body also served generally to insulate the President from official involvement and accountability in the approval process until 1974.⁵

—As high-level government officials, 40 Committee members have had neither the time nor inclination to adequately review and pass judgment on all of the literally hundreds of covert action projects. Indeed, only a small fraction of such projects (those which the CIA regards as major or sensitive) are so approved and/or reviewed. This

⁴ See definition, p. 141.

⁵ Appendix D, Senate Select Committee Hearings, Vol. 7, p. 230.

In 1974 the Hughes-Ryan Amendment (22 USC, 2422, section 602) was enacted. It provides that no funds appropriated under the Foreign Assistance Act or any other act may be expended by or on behalf of CIA foreign operations other than for obtaining necessary intelligence "unless and until the President finds that each such operation is important to the national security of the United States and reports, in a timely fashion, a description and scope of such operation to the appropriate committees of the Congress . . ."

problem is aggravated by the fact that the 40 Committee has had virtually no staff, with only a single officer from the Clandestine Services acting as executive secretary.

—The process of review and approval has been, at times, only general in nature. It sometimes has become *pro forma*, conducted over the telephone by subordinates.

—The President, without consulting any NSC mechanism, can exercise personal direction of clandestine activities as he did in the case of Chile in 1970.

—There is no systematic White House-level review of either sensitive foreign espionage or counterintelligence activities. Yet these operations may also have a potential for embarrassing the United States and sometimes may be difficult to distinguish from covert action operations. For example, a proposal to recruit a high foreign government official as an intelligence "asset" would not necessarily be reviewed outside the Central Intelligence Agency at the NSC level, despite the implications that recruitment might pose in conducting American foreign relations. Similarly, foreign counterintelligence operations might be conducted without any prior review at the highest government levels. The Committee found instances in the case of Chile when counterintelligence operations were related to, and even hard to distinguish from, the program of covert action.

—The President's proposals to upgrade the 40 Committee into the Operations Advisory Group and to give explicit recognition to its role in advising the President on covert activities are desirable. That upgrading, however, will strain further the Group's ability to conduct a systematic review of sensitive clandestine operations. Under the new structure, the Group members are cabinet officers who have even less time than their principal deputies, who previously conducted the 40 Committee's work. The Group's procedures must be carefully structured, so that the perspective of Cabinet officers can in fact be brought to bear.

2. Counterintelligence

—There is no NSC-level mechanism for coordinating, reviewing or approving counterintelligence activities in the United States, even those directed at United States citizens, despite the demonstrated potential for abuse. Both the FBI and the CIA are engaged in counterintelligence, with the CIA operating primarily abroad. The Committee found frictions between the two agencies over the last thirty-five years. The so-called Huston Plan, discredited because of its excessive scope and patent illegalities, was justified in part as a response to the need for improved CIA-FBI coordination. At the same time, the Huston Plan episode illustrates the questions of propriety and legality which may arise in counterintelligence operations conducted in the United States or involving American citizens.

3. Coordination and Resource Allocation

—The Director of Central Intelligence has been assigned the function of coordinating the activities of the intelligence community, ensuring its responsiveness to the requirements for national intelligence, and for assembling a consolidated national intelligence budget. Until the recent establishment of the Committee on Foreign Intelligence (CFI), there was no effective NSC-level mechanism for any of these purposes. The Committee believes that the CFI is a step in the right direction and is to be commended. However, the language of the Presi-

dential Order is such that much will depend on how the order is in fact implemented. "Manage" and "coordinate" are terms that are general in nature and have proven to be so in matters of intelligence. Because the CFI was formed only recently, questions remain about its operation and its relation to the DCI's current responsibilities and to the existing authority of the Secretary of Defense.

Moreover, the Committee notes that a major collector and consumer of intelligence information, the Department of State, is not represented on the CFI. It should be. Other agencies with an important stake in intelligence, such as the Department of the Treasury, the Energy Resources Development Administration, and the Arms Control and Disarmament Agency should play an appropriate role in the CFI on an ad hoc basis.

4. Executive Oversight

—The Committee finds that Presidents have not established specific instruments of oversight to prevent abuses by the intelligence community. In essence, Presidents have not exercised effective oversight.

—The President's Foreign Intelligence Advisory Board (PFIAB) has served Presidents as a useful "Kitchen Cabinet" for intelligence and related matters. It has carried out studies that have resulted in useful changes in procedure and emphasis within the intelligence community, as well as in the adoption of new technologies and techniques. At the same time, the Committee has found that any expectations that PFIAB would serve as an independent watchdog have been mistaken. The PFIAB has been given neither statutory nor Presidential authority to serve such a function. For instance, when the Board became aware of the Huston Plan, it asked the Attorney General and the Director of the FBI for a copy of the plan. That request was refused, and the Board did not pursue the matter with the White House.

—The Committee finds the President's recent establishment of the Intelligence Oversight Board to be long overdue. In the Committee's opinion, however, this does not eliminate the need for vigorous congressional oversight. Moreover, the Order is broadly phrased and at some points ambiguous. The effectiveness of the Oversight Board, as well as the rest of the President's reforms, will depend in large measure on the details of their implementation.

The Committee makes the following recommendations concerning the National Security Council and the Office of the President. These recommendations are designed to support and extend the measures taken recently by the President.

Recommendations

5. By statute, the National Security Council should be explicitly empowered to direct and provide policy guidance for the intelligence activities of the United States, including intelligence collection, counterintelligence, and the conduct of covert action.

6. By statute, the Attorney General should be made an advisor to the National Security Council in order to facilitate discharging his responsibility to ensure that actions taken to protect American national security in the field of intelligence are also consistent with the Constitution and the laws of the United States.

7. By statute, the existing power of the Director of Central Intelligence to coordinate the activities of the intelligence community

should be reaffirmed. At the same time, the NSC should establish an appropriate committee—such as the new Committee on Foreign Intelligence—with responsibility for allocating intelligence resources to ensure efficient and effective operation of the national intelligence community. This committee should be chaired by the DCI and should include representatives of the Secretary of State, the Secretary of Defense, and the Assistant to the President for National Security Affairs.⁶

8. By statute, an NSC committee (like the Operations Advisory Group) should be established to advise the President on covert action. It would also be empowered, at the President's discretion, to approve *all* types of sensitive intelligence collection activities. If an OAG member dissented from an approval, the particular collection activity would be referred to the President for decision. The Group should consist of the Secretary of State, the Secretary of Defense, the Assistant to the President for National Security Affairs, the Director of Central Intelligence, the Attorney General, the Chairman of the Joint Chiefs of Staff, and the Director of OMB, as an observer. The President would designate a chairman from among the Group's members.

9. The chairman of the Group would be confirmed by the Senate for that position if he were an official not already subject to confirmation. In the execution of covert action and sensitive intelligence collection activities specifically approved by the President, the chairman would enter the chain of command below the President.

10. The Group should be provided with adequate staff to assist in conducting thorough reviews of covert action and sensitive collection projects. That staff should not be drawn exclusively from the Clandestine Service of the CIA.

11. Each covert action project should be reviewed and passed on by the Group. In addition, the Group should review all on-going projects at least once a year.

12. By statute, the Secretary of State should be designated as the principal administration spokesman to the Congress on the policy and purpose underlying covert action projects.

13. By statute, the Director of Central Intelligence should be required to fully inform the intelligence oversight committee(s) of Congress of each covert action prior to its initiation. No funds should be expended on any covert action unless and until the President certifies and provides to the congressional intelligence oversight committee(s) the reasons that a covert action is required by extraordinary circumstances to deal with grave threats to the national security of the United States. The congressional intelligence oversight committee(s) should be kept fully and currently informed on all covert action projects, and the DCI should submit a semi-annual report on all such projects to the committee(s).

14. The Committee recommends that when the Senate establishes an intelligence oversight committee with authority to authorize the na-

⁶ In effect, this recommendation would establish the President's proposed Committee on Foreign Intelligence in law but would include a representative of the Secretary of State. It would also empower the DCI to establish intelligence requirements. See Recommendation #10, p. 434.

⁷ A covert action would consist of either a major project, or an aggregation of smaller projects meeting the standards of this paragraph.

tional intelligence budget, the Hughes-Ryan Amendment (22 USC, 2422) should be amended so that the foregoing notifications and presidential certifications to the Senate are provided only to that committee.

15. By statute, a new NSC counterintelligence committee should be established, consisting of the Attorney General as chairman, the Deputy Secretary of Defense, the Director of Central Intelligence, the Director of the FBI, and the Assistant to the President for National Security Affairs. Its purpose would be to coordinate and review foreign counterintelligence activities conducted within the United States and the clandestine collection of foreign intelligence within the United States, by both the FBI and the CIA. The goal would be to ensure strict conformity with statutory and constitutional requirements and to enhance coordination between the CIA and FBI.⁸ This committee should review the standards and guidelines for all recruitments of agents within the United States for counterintelligence or positive foreign intelligence purposes, as well as for the recruitment of U.S. citizens abroad. This committee would consider differences between the agencies concerning the recruitment of agents, the handling of foreign assets who come to the United States, and the establishment of the bona fides of defectors. It should also treat any other foreign intelligence or counterintelligence activity of the FBI and CIA which either agency brings to that forum for presidential level consideration.

EXECUTIVE COMMAND AND CONTROL/INTELLIGENCE ACTIVITIES

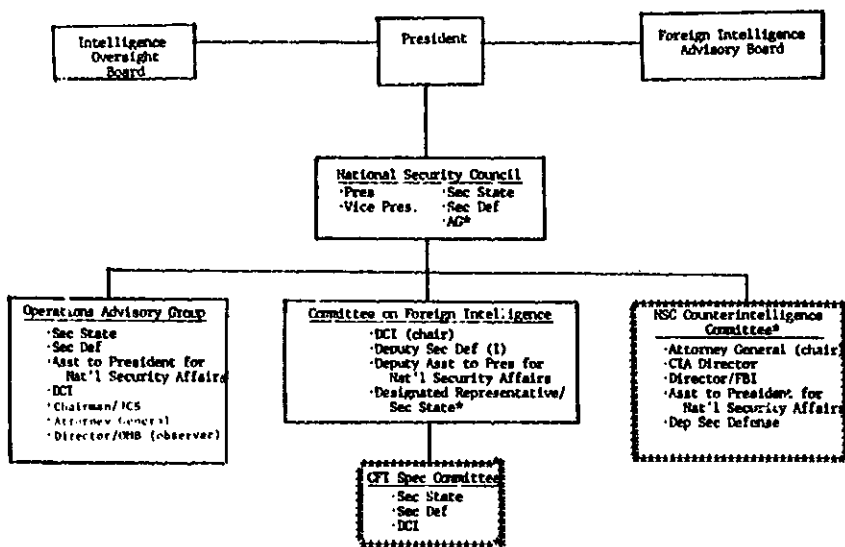

*Committee Recommendations

⁸ See related legislative proposals in the Committee's Report on Intelligence Activities and the Rights of Americans.

E. THE DIRECTOR OF CENTRAL INTELLIGENCE

The 1947 National Security Act gave the DCI responsibility for "coordinating the intelligence activities of the several Government departments and agencies in the interest of national security." In addition, the DCI as the President's principal foreign intelligence adviser was given responsibility for coordinating and producing national intelligence for senior policymakers. However, the Committee found that these DCI responsibilities have often conflicted with the particular interests and prerogatives of the other intelligence community departments and agencies. They have not given up control over their own intelligence operations, and in particular the Department of Defense and the military services, which allocate 80 percent of the direct costs for national intelligence, have insisted that they must exercise direct control over peacetime intelligence activities to prepare for war. Thus, while the DCI was given responsibility under the 1947 act for intelligence community activities, he was not authorized to centrally coordinate or manage the overall operations of the community.

1. Coordinator of the Intelligence Community

The Committee has found that the DCI in his coordinator role has been unable to ensure that waste and unnecessary duplication are avoided. Because the DCI only provides guidance for intelligence collection and production, and does not establish requirements, he is not in a position to command the intelligence community to respond to the intelligence needs of national policymakers. Where the DCI has been able to define priorities, he has lacked authority to allocate intelligence resources—either among different systems of intelligence collection or among intelligence collection, analysis and finished intelligence production.

The Committee supports President Ford's objectives of enhancing the stature of the DCI and establishing a mechanism such as the Committee on Foreign Intelligence (CFI) with the DCI as chairman to control the allocation of national intelligence programs resources. The Committee questions, however, whether the CFI can be effective without some appropriate modification of the peacetime authority of the Secretary of Defense. In order to strike an appropriate balance between the requirements of national and tactical intelligence, the intelligence collected by national means should be readily available to the military commanders and vice versa, and the Secretary of Defense and the military services should retain direct control over the operations of tactical military intelligence. Nonetheless, the DCI needs the right to review tactical military intelligence operations in order to make budget choices between tactical and national intelligence activities. Moreover, to carry out his coordinating role, the DCI needs to retain control over major technical intelligence collection systems which service both tactical and national intelligence requirements.

2. Producer of National Intelligence

In the area of providing finished intelligence, the Committee discovered that the DCI, in his role as intelligence adviser, has faced obstacles in ensuring that his national intelligence judgments are objective and independent of department and agency biases. The Committee

has been particularly concerned with pressures from both the White House and the Defense Department on the DCI to alter his intelligence judgments. One example of such pressure investigated by the Committee occurred in the fall of 1969 when the DCI modified his judgment on the capability of the Soviet SS-9 system when it conflicted with the public position of Secretary of Defense Laird. After a meeting with staff of the Office of the Secretary of Defense, Director Helms deleted a paragraph from the draft of the National Intelligence Estimate on Soviet strategic forces which stated that within the next five years it was "highly unlikely" that the Soviets would attempt to achieve "a first strike capability, i.e., a capability to launch a surprise attack against the United States with assurance that the U.S.S.R. would not itself receive damage it would regard as unacceptable."

The Committee believes that over the past five years the DCI's ability to produce objective national intelligence and resist outside pressure has been reduced with the dissolution of the independent Board of National Estimates and the subsequent delegation of its staff to the departments with responsibility for drafting the DCI's national intelligence judgments.

In the end, the DCI must depend on his position as the President's principal intelligence adviser or on his personal relationship with the President to carry out his various responsibilities and to withstand pressures to compromise his intelligence judgments. Consequently, the Committee has been concerned that the DCI's proximity and access to the President has diminished over the years. Since 1969, at least until the confirmation of Mr. Bush, the DCI has rarely seen the President except at NSC meetings. The influence a DCI could have from a close relationship with the President has generally been lacking.

While President Ford's Executive Order is a step in the right direction, the Committee believes that the DCI's responsibility over intelligence community activities should be enhanced and spelled out clearly and in detail in statute. The Executive should not continue defining these responsibilities alone as it has done since 1947 through Executive Orders and National Security Council Intelligence Directives (NSCIDs).

The Committee believes that the Congress, in carrying out its responsibilities in the area of national security policy, should have access to the full range of intelligence produced by the United States intelligence community. The Committee further believes that it should be possible to work out a means of ensuring that the DCI's national intelligence judgments are available to the appropriate Congressional committees on a regular basis without compromising the DCI's role as personal adviser to the President.

Finally, the Committee has found concern that the function of the DCI in his roles as intelligence community leader and principal intelligence adviser to the President is inconsistent with his responsibility to manage one of the intelligence community agencies—the CIA. Potential problems exist in a number of areas. Because the DCI as head of the CIA is responsible for human clandestine collection overseas, interception of signals communication overseas, the development

and interception of technical collection systems, there is concern that the DCI as community leader is in "a conflict of interest" situation when ruling on the activities of the overall intelligence community.

The Committee is also concerned that the DCI's new span of control—both the entire intelligence community and the entire CIA—may be too great for him to exercise effective detailed supervision of clandestine activities.

Recommendations

16. By statute, the DCI should be established as the President's principal foreign intelligence adviser, with exclusive responsibility for producing national intelligence for the President and the Congress. For this purpose, the DCI should be empowered to establish a staff directly responsible to him to help prepare his national intelligence judgments and to coordinate the views of the other members of the intelligence community. The Committee recommends that the Director establish a board to include senior outside advisers to review intelligence products as necessary, thus helping to insulate the DCI from pressures to alter or modify his national intelligence judgments. To advise and assist the DCI in producing national intelligence, the DCI would also be empowered to draw on other elements of the intelligence community.

17. By statute, the DCI should be given responsibility and authority for establishing national intelligence requirements, preparing the national intelligence budget, and providing guidance for United States national intelligence program operations. In this capacity he should be designated as chairman of the appropriate NSC committee, such as the CFI, and should have the following powers and responsibilities:

a. The DCI should establish national intelligence requirements for the entire intelligence community. He should be empowered to draw on intelligence community representatives and others whom he may designate to assist him in establishing national intelligence requirements and determining the success of the various agencies in fulfilling them. The DCI should provide general guidance to the various intelligence agency directors for the management of intelligence operations.

b. The DCI should have responsibility for preparing the national intelligence program budget for presentation to the President and the Congress.* The definition of what is to be included within that national intelligence program should be established by Congress in consultation with the Executive. In this capacity, the Director of Central Intelligence should be involved early in the budget cycle in preparing the budgets of the respective intelligence community agencies. The Director should have specific responsibility for choosing among the programs of the different collection and production agencies and departments and to insure against waste and unnecessary duplication. The DCI should also have responsibility for issuing fiscal guidance for the allocation of all national intelligence resources. The authority of the

* [The DCI] shall: Ensure the development and submission of a budget for the National Foreign Intelligence Program to the CFI. (Executive Order 11907, Sec. 3(d)iii.)

DCI to reprogram funds within the intelligence budget should be defined by statute.¹⁰

c. In order to carry out his national intelligence responsibilities the DCI should have the authority to review all foreign and military intelligence activities and intelligence resource allocations, including tactical military intelligence which is the responsibility of the armed forces.¹¹

d. The DCI should be authorized to establish an intelligence community staff to support him in carrying out his managerial responsibilities. This staff should be drawn from the best available talent within and outside the intelligence community.

e. In addition to these provisions concerning DCI control over national intelligence operations in peacetime, the statute should require establishment of a procedure to insure that in time of war the relevant national intelligence operations come under the control of the Secretary of Defense.

18. By statute, the position of Deputy Director of Central Intelligence for the intelligence community should be established as recommended in Executive Order 11905. This Deputy Director should be subject to Senate confirmation and would assume the DCI's intelligence community functions in the DCI's absence. Current provisions regarding the status of the DCI and his single deputy should be extended to cover the DCI and both deputies. Civilian control of the nation's intelligence is important; only one of the three could be a career military officer, active or retired.

19. The Committee recommends that the intelligence oversight committee(s) of Congress consider whether the Congress should appropriate the funds for the national intelligence budget to the DCI, rather than to the directors of the various intelligence agencies and departments.

20. By statute, the Director of Central Intelligence should serve at the pleasure of the President but for no more than ten years.

21. The Committee also recommends consideration of separating the DCI from direct responsibility over the CIA.¹²

F. THE CENTRAL INTELLIGENCE AGENCY

1. *The Charter for Intelligence Activities: Espionage, Counterintelligence and Covert Action*

The Committee finds that the CIA's present charter, embodied in the National Security Act of 1947, the CIA Act of 1949, and the 1974 Hughes-Ryan amendments to the Foreign Assistance Act, is inadequate in a number of respects.

¹⁰ "Reprogramming" means shifting money previously approved for one purpose to another use; for instance, from clandestine human collection to technical collection or covert action.

¹¹ In contrast to President Nixon's 1971 letter to Director Helms which asked the DCI to plan and review "... all intelligence activities including tactical intelligence and the allocation of all intelligence resources," President Ford's Executive Order 11905 states that "... neither the DCI nor the CFI shall have responsibility for tactical intelligence."

¹² See discussion on pp. 440-450.

While the legislative history of the 1947 Act makes clear that the CIA's mandate would be limited to "foreign intelligence," the Act itself does not so specify. Covert action, in the past a major CIA activity, is not mentioned in the 1947 Act, although the Act contains a vague and open-ended authorization for the National Security Council to direct the CIA to undertake "such other functions and duties related to the intelligence affecting the national security as the NSC may from time to time direct."¹³ No explicit authority even to collect intelligence is provided the Agency.

The restrictions on domestic activities in the 1947 Act were not clearly defined, nor was the potential conflict between these limits and the Director's authority to protect "sources and methods" of intelligence gathering resolved. Neither did the 1947 Act set forth the Agency's role in conducting counterintelligence and in collecting foreign intelligence.

The Congress' confusing and ill-defined charge to the Agency in these areas resulted in conflicts of jurisdiction with other government agencies. The lack of legislative specificity also opened the way to domestic activities such as Operation CHAOS¹⁴ which clearly went beyond Congress' intent in enacting and amending the National Security Act. In sum, the Committee finds that a clear statutory basis is needed for the Agency's conduct abroad of covert action, espionage, counterintelligence and foreign intelligence collection and for such counterespionage operations within the United States as the Agency may have to undertake as a result of the activities abroad.¹⁵

Foreign Espionage

Espionage is often equated with the slightly broader category of "clandestine human collection." Although "clandestine human collection" may include collection of public information by a covert source, espionage centers on recruiting and handling agents to acquire "protected" or "denied" information.

Espionage on behalf of the United States Government is primarily the responsibility of the Central Intelligence Agency's Clandestine Service which operates on a world-wide basis. The Clandestine Service—officially, the Directorate of Operations—is responsible for CIA clandestine human collection, espionage, covert action, paramilitary operations and counterintelligence. The CIA also has special responsibilities for coordinating the military services' limited espionage activities abroad.

By CIA doctrine, espionage should be aimed at securing information others wish to conceal and not at collecting information available through diplomatic channels or from public sources, such as the press, television and radio.

The Clandestine Service regards espionage, rather than covert action and other such activities, as the essence of its mission. Indeed, the Committee found that clandestine human intelligence collection is often considered a prerequisite as well as a precursor of successful covert action, paramilitary activity, and counterintelligence.

¹³ Appendix B, Hearings, Vol. 7, p. 210.

¹⁴ See the Committee's detailed report on Protect CHAOS.

¹⁵ See the Committee's Report on Domestic Intelligence, Part IV, for recommended limitations on such activity.

Espionage targets vary, covering political, military and economic information wherever we perceive a national interest. Espionage involves a variety of techniques, ranging from technical surveillance, break-ins and theft, to human reporting by controlled agents, paid and unpaid of protected information. It is generally illegal in the countries against which it is aimed, but its widespread practice by nation states makes the status of espionage under international law ambiguous.

Covert action, which is designed to have an impact, differs from clandestine collection and classic espionage, which are designed to obtain intelligence without affecting the source or revealing the fact that the information has been collected. In practice, however, covert action and espionage overlap, since they rely on the same CIA officers, foreign intermediaries, and sources of information.¹⁰

The Committee believes that the United States cannot forego clandestine human collection and expect to maintain the same quality of intelligence on matters of the highest importance to our national security. Technical collection systems do not eliminate the usefulness of espionage in denied areas (essentially the communist countries). Agent intelligence can help provide valuable insight concerning the motivations for activities or policies of potential adversaries, as well as their future intentions.

Nevertheless, the Committee found that there are certain inherent limitations to the value of clandestine sources. Espionage information tends to be fragmentary, and there is always some question as to the trustworthiness and reliability of the source.

The Committee found that over the last decade, the size of the Clandestine Service has been reduced significantly, particularly in the field. However, there remains the question of whether the complements abroad and at headquarters have been reduced sufficiently.

The Committee found that the CIA's clandestine collection effort has been reoriented towards denied areas and away from internal political and security developments in the Third World. The Committee believes that this changed emphasis is desirable and welcomes it.

The Committee found that while internal supervision of espionage within the CIA appears sufficient, there is inadequate external review and control over CIA espionage activities. There is no effective machinery to ensure that the Secretaries of States and Defense and the Assistant to the President for National Security Affairs, who are knowledgeable about the value and limitations of espionage, systematically participate directly in decisions concerning such issues as how large our espionage effort should be, the relative priorities, risk assessments, and possible duplication of effort between overt and clandestine human collection.

The Committee notes that the duplication between the CIA's Clandestine Service and the State Department's overt Foreign Service reporting appears to have diminished in recent years. However, William Colby when he was DCI voiced concern that the problem had not been solved. The Committee notes that increased collection efforts regarding economic issues may aggravate the overlap problem.

¹⁰ Senate Select Committee, "Covert Action in Chile," p. 6ff.

Foreign Intelligence Collection in the United States

The CIA engages in both overt and clandestine activity within the United States for the purpose of foreign intelligence collection. The Domestic Collection Division (DCD) is responsible primarily for overt collection, while the Foreign Resources Division (FRD) manages clandestine collection of foreign intelligence. Both divisions are currently within the Directorate of Operations. Formerly run and staffed by the Directorate of Intelligence, the DCD was moved to Operations in 1973 and now has many clandestine services officers assigned to it.

The Domestic Collection Division openly collects foreign intelligence information from American citizens on a wide variety of subjects, primarily of an economic and technological nature. The Domestic Collection Division currently maintains contact with tens of thousands of American citizens who, on a confidential basis, volunteer information of intelligence value to the United States. The Committee notes that the Central Intelligence Agency is *overtly* in contact with many members of the American academic community to consult with them on the subjects of their expertise. On occasion, at the request of the academic concerned, these contacts are confidential.

The Committee believes there are significant benefits to both the government and the universities in such contacts and that they should not be discouraged. The Committee sees no danger to the integrity of American academic institutions in continuing such overt contacts.

The Domestic Collection Division operates from 38 offices around the United States and lists itself in local telephone directories, although it conducts its business as discretely as possible.

The Foreign Resources Division (FRD) performs its functions in a more traditional operational manner much as it is done overseas; foreign nationals of special interest, located in the United States, are enlisted to cooperate secretly with the CIA abroad. FRD's activity, which takes place throughout the United States, is carried out by some of CIA's very best personnel. In the performance of its job, FRD maintains contact with a large number of Americans who are witting of its mission and willing to be cooperative. There are also a number of Americans who are not aware that they are participating in such CIA activities.¹⁷

The Committee believes that the activities of the Foreign Resources Division and the Domestic Collection Division make an important and useful contribution to the overall intelligence effort; however, there are significant problems.

The Committee found that the Domestic Collection Division, subsidiary to its overt role, supports the clandestine components of the CIA. It provides such services as re-settling defectors, and, by drawing on DCD's extensive contacts in the U.S., reports leads regarding foreign nationals who could prove useful abroad or U.S. firms whose offices abroad could help the CIA.

The Committee is concerned that this kind of assistance provided by the Domestic Collection Division, if not closely watched, could lead to an exploitation of cooperating Americans beyond that which

¹⁷ For explanation of Italics, see footnote, p. 170.

they, themselves, envisioned or beyond these limited CIA objectives.¹⁸

The Committee notes that due to the recent revelations about CIA activities, some foreign intelligence sources are shying away from cooperation with the Domestic Collection Division, thus impeding this division's most important function, namely, the overt collection of foreign intelligence.

The Committee also questions the recruiting, for foreign espionage purposes, of immigrants desiring American citizenship, because it might be construed as coercive.

*Foreign Counterintelligence*¹⁹

Counterintelligence is defined quite broadly by the CIA. It includes the knowledge needed for the protection and preservation of the military, economic, and productive strength of the United States, as well as the government's security in domestic and foreign affairs, against or from espionage, sabotage, and subversion designed to weaken or destroy the United States.

Counterintelligence (CI) is a special form of intelligence activity, aimed at discovering hostile foreign intelligence operations and destroying their effectiveness. It involves protecting the United States Government against infiltration by foreign agents, as well as controlling and manipulating adversary intelligence operations. An effort is made to discern the plans and intentions of enemy intelligence services and to deceive them about our own.

The Committee finds that the threat from hostile intelligence services is real. In the United States alone, well over a thousand Soviet officials are on permanent assignment. Among these, over 40 percent have been identified as members of the KGB or GRU, the Soviet civilian and military intelligence units, respectively. Estimates for the number of *unidentified* Soviet intelligence officers raise this figure to over 60 percent and some defector sources have estimated that 70 percent to 80 percent of Soviet officials in the United States have some intelligence connection.

Furthermore, the number of Soviets with access to the United States has tripled since 1960, and is still increasing. In 1974, for example, over 200 Soviet ships with a total crew complement of 13,000 officers and men visited this country. Some 4,000 Soviets entered the United States as commercial or exchange visitors in 1974. In 1972-1973, for example, approximately one third of the Soviet exchange students here for the academic year under the East-West student exchange program were cooperating with the KGB, according to the Central Intelligence Agency.

Other areas of counterintelligence concern include the sharp increase in the number of Soviet immigrants to the United States (4,000 in 1974 compared to fewer than 500 in 1972); the rise in East-West commercial exchange visitors (from 641 in 1972 to 1,500 in 1974); and the growing number of officials in this country from other Communist bloc nations (from 416 in 1960 to 798 in 1975).

Both the FBI and the CIA are engaged in counterintelligence work. The CIA operates primarily abroad. Within the United States the

¹⁸ *Ibid.*

¹⁹ See also the Select Committee Report on CHAOS and the counterintelligence recommendations in the committee's Report on Domestic Intelligence Activities and the Rights of Americans, Part IV.

counterintelligence mission is conducted by the FBI, except when the CIA, in consultation with the FBI, continues activities begun abroad.

Defectors are an important source of counterintelligence. Within the United States, the interrogation of defectors is primarily the responsibility of the FBI, though the CIA may also participate. Sometimes, however, the bona fides of a defector are disputed between the CIA and the FBI and there is no established interagency mechanism for settling such disputes—which may last for years. An incident in which a defector was held in so-called “incommunicado interrogation” for two years was, in part, a result of the lack of such a mechanism.²⁰

Liaison among the various U.S. Government counterintelligence units at home is particularly important, because counterintelligence—with all its intricacies and deceptions—requires coordination among agencies and sharing of records. Unlike the totally unified KGB organization, the American intelligence service is fragmented and depends upon liaison to make operations more effective.

Coordination between CIA and FBI counterintelligence units is especially critical. The history of CIA-FBI liaison has been turbulent, though a strong undercurrent of cooperation has usually existed at the staff level since 1952 when the Bureau began sending a liaison person to the CIA on a regular basis. The sources of friction between the CIA and FBI in the early days revolved around such matters as the frequent unwillingness of the Bureau to collect positive intelligence for the CIA within the United States or to help recruit foreign officials in this country.

In 1970 an essentially minor incident resulted in an order from FBI Director Hoover to discontinue FBI liaison with the Central Intelligence Agency. Although informal communications between CIA and FBI staff personnel continued, it was not until the post-Hoover era that formal liaison relations were reestablished. Today, there is still a need for closer coordination of FBI and CIA counterintelligence efforts.

The Committee believes that counterintelligence requires the direct attention of Congress and the executive for three reasons: (1) two distinct and partly incompatible approaches to counterintelligence have emerged and demand reconciliation; (2) recent evidence suggests that FBI counterespionage results have been less than satisfactory; and (3) counterintelligence has infringed on the rights and liberties of Americans.

Disagreement over the approach to counterintelligence affects all aspects of this activity—compartmentation, method of operation, security, research priorities, deception activities, and liaison. The Committee found that there has been no high-level executive branch review of the classified issues surfaced in this important disagreement.

The Committee also found that there is no system of clearance outside the CIA or FBI for sensitive counterespionage operations,

²⁰ Recommendation 14 is based, in part, on these findings.

despite the difficulty of distinguishing some of these operations from covert action.

On the FBI contribution to counterintelligence, testimony before the Committee reveals that the Bureau has given insufficient priority to discovering and controlling foreign agents within the United States. Insufficient manpower in the counterintelligence field, especially highly trained analysts, appears to be part of the problem.

Recommendations

22. By statute, a charter should be established for the Central Intelligence Agency which makes clear that its activities must be related to foreign intelligence. The Agency should be given the following missions:

- The collection of denied or protected foreign intelligence information.³
- The conduct of foreign counterintelligence.²⁴
- The conduct of foreign covert action operations.
- The production of finished national intelligence.

23. The CIA, in carrying out foreign intelligence missions, would be permitted to engage in relevant activities within the United States so long as these activities do not violate the Constitution nor any federal, state, or local laws within the United States.²⁵ The Committee has set forth in its Domestic Recommendations proposed restrictions on such activities to supplement restrictions already contained in the 1947 National Security Act. In addition, the Committee recommends that by statute the intelligence oversight committee(s) of Congress and the proposed counterintelligence committee of the National Security Council be required to review, at least annually, CIA foreign intelligence activities conducted within the United States.²⁶

24. By statute, the Attorney General should be required to report to the President and to the intelligence oversight committee(s) of Congress any intelligence activities which, in his opinion, violate the Constitutional rights of American citizens or any other provision of law and the actions he has taken in response. Pursuant to the Committee's Domestic Recommendations, the Attorney General should be made responsible for ensuring that intelligence activities do not violate the Constitution or any other provision of law.

25. The Committee recommends the establishment of a special committee of the Committee on Foreign Intelligence to review all foreign human intelligence collection activities. It would make recommendation activities. (See the committee's Report on Domestic Intelligence Activities and the Rights of Americans, Part IV.)

U.S. clandestine human collection operations and choices between overt and clandestine human collection. This committee would be

³ This would not preclude the NSC from assigning appropriate overt collection functions to the CIA.

²⁴ The CIA would be excluded from any law enforcement or criminal investigation activities. (See the Committee's Report on Domestic Intelligence Activities and the Rights of Americans, Part IV.)

²⁵ *Ibid.*

²⁶ For recommended review requirements for covert action operations, see p. 26 ff.

composed of a representative of the Secretary of State as chairman, the other statutory members of the CFI, and others whom the President may designate.

26. The intelligence oversight committee(s) of Congress should carefully examine intelligence collection activities of the Clandestine Service to assure that clandestine means are used only when the information is sufficiently important and when such means are necessary to obtain the information.

27. The intelligence oversight committee(s) should consider whether:

- the Domestic Collection Division (overt collection operations) should be removed from the Directorate of Operations (the Clandestine Service), and returned to the Directorate of Intelligence;
- the CIA's regulations should require that the DCD's overt contacts be informed when they are to be used for operational support of clandestine activities;
- the CIA's regulations should prohibit recruiting as agents immigrants who have applied for American citizenship.

28. The President of the United States, in consultation with the intelligence oversight committee(s) of Congress, should undertake a classified review of current issues regarding counterintelligence. This review should form the basis for a classified Presidential statement on national counterintelligence policy and objectives, and should closely examine the following issues: compartmentation, operations, security, research, accountability, training, internal review, deception, liaison and coordination, and manpower.

2. *CIA Production of Finished Intelligence*

Intelligence production refers to the process (coordination, collation, evaluation, analysis, research, and writing) by which "raw" intelligence is transformed into "finished" intelligence for senior policymakers. The finished intelligence product includes a daily report and summaries, as well as longer analytical studies and monographs on particular topics of policy interest. In the CIA, finished intelligence is produced by the Directorate of Intelligence and the Directorate of Science and Technology.

Certain problems and issues in the area of CIA intelligence production have come to the Committee's attention. The Committee believes these problems deserve immediate attention by both the executive branch and future congressional intelligence oversight bodies. These problems bear directly on the resources allocated to the production of finished intelligence, the personnel system, and the organizational structure of intelligence production.

The Committee recognizes that it is not the primary purpose of intelligence to predict every world event. Rather, the principal function of intelligence is to anticipate major foreign developments and changes in policies which bear on United States interests. Intelligence should also provide a deeper understanding of the behavior, processes, and long-term trends which may underlie sudden military and political developments.

The Committee wishes to emphasize that there is an important difference between an intelligence failure and a policy failure. The United States had intelligence on the possibility of a Turkish invasion of Cyprus in 1974. The problem of taking effective action to prevent such an invasion was a policy question and not an intelligence failure.

The Committee has received evidence that on some subjects, such as the current capability of the strategic and conventional forces of potential adversaries, U.S. intelligence is considered excellent. But in other areas, U.S. finished intelligence is viewed by policymakers as far from satisfactory in light of the total resources devoted to intelligence. On balance, the Committee found that the quality, timeliness, and utility of our finished intelligence is generally considered adequate, but that major improvement is both desirable and possible.

One issue examined by the Committee is whether intelligence community elements responsible for producing finished intelligence receive adequate attention and support. Production is, in the words of one observer, "the stepchild of the intelligence community." Since finished intelligence is a principal purpose of all United States intelligence activities, the Committee finds that this neglect of finished intelligence is unacceptable for the future.

Intelligence resources are overwhelmingly devoted to intelligence collection. The system is inundated with raw intelligence. The individual analysts responsible for producing finished intelligence has difficulty dealing with the sheer volume of information. Policymakers want the latest reports, and producers of finished intelligence often have to compete with the producers of raw intelligence for policymakers' attention. In a crisis situation, analysts tend to focus on the latest piece of evidence at the expense of a longer and broader view. Intelligence Community staff saw this tendency as one reason why the Cyprus coup in July 1974 was not foreseen.

The Intelligence Community staff in its post-mortem on the 1974 Cyprus crisis noted another general analytical problem which was involved in the failure to anticipate the Cyprus coup and the Arab attack on Israeli forces in October of 1973: "the perhaps subconscious conviction (and hope) that, ultimately, reason and rationality will prevail, that apparently irrational moves (the Arab attack, the Greek sponsored coup) will not be made by essentially rational men."

An additional area of the Committee's concern is that analysts are often not informed in a timely way of national policies and programs which affect their analyses and estimates. In its examination of cases involving Cambodia and Chile in the 1970s, the Committee encountered evidence that the analysts were so deprived.

Another issue uncovered by the Committee is whether the highest quality personnel are recruited into the CIA analytical staff. Among the problems raised:

- Analysts tend to be hired early in their careers, and stay in the Agency throughout their careers. The nature of their work tends to insulate them from other useful experiences.
- The analysts career pattern rewards most analyst by promoting them to supervisory positions thereby reducing the time available to utilize their analytical skills.

- Some analysts complain that there are too many steps in the process for reviewing finished intelligence—too much bureaucratic “layering” in the analytical components. With each successive level of review, the analysis and commentary tend to become increasingly derivative.
- There has been little lateral entry of established analysts and intelligence experts into CIA ranks to leaven the outlook, interests and skills of the Agency’s intelligence analysts.²⁷

A final issue raised by the Committee’s investigation of intelligence production is whether the new organizational structure proposed by the President will assure the appropriate stature for the Directorate of Intelligence to help overcome existing problems in the production of finished intelligence. Instead of reporting directly to the DCI (who is still to be the President’s chief intelligence adviser), CIA analysts may well report through the Deputy for the CIA. Experience indicates that the new Deputy will need to devote the bulk of his time to managing the Clandestine Services and the Directorate for Science and Technology. At the same time, the DCI may be preoccupied with greater community-wide management responsibilities. Without some further restructuring, the Committee believes that the production of finished intelligence may be lost in the shuffle.

Recommendations

29. By statute, the Director of the Directorate of Intelligence (DDI) should be authorized to continue to report directly to the Director of Central Intelligence.

30. The Committee recommends that a system be devised to ensure that intelligence analysts are better and more promptly informed about United States policies and programs affecting their respective areas of responsibility.

31. The Central Intelligence Agency and the intelligence oversight committee(s) of Congress should reexamine the personnel system of the Directorate of Intelligence with a view to providing a more flexible, less hierarchical personnel system. Super-grade positions should be available on the basis of an individual’s analytical capabilities.

32. The Directorate for Intelligence should seek to bring more established analysts into the CIA at middle and upper grade levels for both career positions and temporary assignments.

33. Greater emphasis should be placed on stimulating development of new tools and methods of analysis.

34. Agency policy should continue to encourage intelligence analysts to assume substantive tours of duty on an open basis in other agencies (State, Defense, NSC staff) or in academic institutions to broaden both their analytical outlook and their appreciation for the relevance of their analysis to policymakers and operators within the Government.

²⁷ In FY 1975, only 18 out of 105 analysts hired by the DDI from outside the CIA were at grades GS-12 to GS-15.

3. Covert Action and Paramilitary Operations

Covert action is the attempt to influence the internal affairs of other nations in support of United States foreign policy in a manner that conceals the participation of the United States Government. Covert action includes political and economic action, propaganda and paramilitary activities.

The basic unit of covert action is the project. Covert action "projects" can range from single assets, such as a journalist placing propaganda, through a network of assets working in the media, to major covert and military intervention such as in Laos. The Agency also maintains what it terms an "operational infrastructure" of "stand-by" assets (agents of influence or media assets) who can be used in major operations—such as in Chile. These "stand-by" assets are also part of on-going, most often routine, projects. There are no inactive assets.

Covert Action

The Committee has found that the CIA has conducted some 900 major or sensitive covert action projects plus several thousand smaller projects since 1961. The need to maintain secrecy shields covert action projects from the rigorous public scrutiny and debate necessary to determine their compatibility with established American foreign policy goals. Recently, a large-scale covert paramilitary operation in Angola was initiated without any effort on the part of the executive branch to articulate, and win public support for, its overall policy in Africa. Only public disclosure has allowed the nation to apply its standards of success or failure to covert action projects and then only in retrospect, often without the benefit of the details prompting the original choice of covert rather than overt action.

The secrecy covert action requires means that the public cannot determine whether such actions are consistent with established foreign policy goals. This secrecy also has allowed covert actions to take place which are inconsistent with our basic traditions and values.

Some covert operations have passed retrospective public judgments, such as the support given Western European democratic parties facing strong communist opposition in the late 1940s and 1950s. Others have not. In the view of the Committee, the covert harassment of the democratically elected government of Salvador Allende in Chile did not command U.S. public approval.

Even if the short-term consequences of covert action are consistent with stated policy and accepted standards, the Committee has found that the continued use of covert action techniques within or against a foreign society can have unintended consequences that sometimes subvert long-term goals. For instance, extended covert support to foreign political leaders, parties, labor unions, or the media has not always accomplished the intended objective of strengthening them against the communist challenge. In some cases, it has both encouraged a debilitating dependence on United States covert support, and made those receiving such support vulnerable to repudiation in their own society when their covert ties are exposed. Furthermore, prolonged covert relations and the resulting dependence of recipients on con-

tinued CIA support seem to encourage the CIA to extend its ties to means of controlling the recipients in other respects. Covert actions also have, over time, developed a bureaucratic momentum of their own that often surpasses the original need for covert action.

Paramilitary Operations

Covert paramilitary operations are a special, extreme form of covert action. These operations most often consist of covert military assistance and training, but occasionally have involved actual combat activities by American advisers.

Because military assistance involves foreign policy commitments, it is, with one exception, authorized by the Congress. That exception is *covert* military assistance which is channeled through the CIA without being authorized or approved by the Congress as a whole.

Covert U.S. paramilitary combat operations frequently amount to making war, but they do not come under the War Powers Act since they usually do not involve *uniformed* U.S. military officers. American military officers engaged in CIA-sponsored paramilitary operations are "sheep-dipped" for paramilitary duty—that is, they appear to resign from the military yet preserve their place for reactivation once their tour as civilian in paramilitary operations has ended.

The Committee finds that major paramilitary operations have often failed to achieve their intended objective. Most have eventually been exposed. Operations, as in Angola, recently, and Indonesia in the late 1950s are examples of such paramilitary failures. Others, such as Laos, are judged successes by the CIA and officials within the executive branch. The "success" in Laos, however, must be seen against the larger American involvement in Indochina which failed.

Paramilitary operations often have evolved into large-scale programs with a high risk of exposure (and thus embarrassment and/or failure). In some cases, the CIA has been used to undertake paramilitary operations simply because the Agency is less accountable to the public for highly visible "secret" military operations. In all cases considered by the Committee, command and control within the executive branch was rigorous. However, all such operations have been conducted without direct congressional authority or public debate. In recent years, some have been continued in the face of strong congressional disapproval.

Recently, however—apart from Angola—United States paramilitary activities have been at a very low level. The capability for these actions, residing jointly in the CIA and the Department of Defense, consists of a cadre of trained officers, stockpiles of military equipment, logistic networks and small collections of air and maritime assets.

Review and Approval of Covert Action

Given the open and democratic assumptions on which our government is based, the Committee has given serious consideration to the option of proposing a total ban on all forms of covert activity. The Committee has concluded, however, that the United States should maintain the capability to react through covert action when no other means will suffice to meet extraordinary circumstances involving grave

threats to U.S. national security. Nevertheless, covert action should be considered as an exception to the normal process of government action abroad, rather than a parallel but invisible system in which covert operations are routine.

Absent some means of assuring public participation in assessing each covert action, the mechanisms of executive branch review and control and of legislative intelligence oversight must serve as the restricted arenas in which such standards are applied to covert action. The Committee's examination of the covert action record over the last 25 years has underscored the necessity for legislative reinforcement of the executive branch's internal review process. This is necessary to assure that all covert action projects are reviewed, and to establish a system of formal accountability within the executive accessible to congressional intelligence oversight bodies.

The CIA has not been free, however, to carry out covert action as it sees fit. The Committee's investigation revealed that on the whole, the Agency has been responsive to internal and external review and authorization requirements. Most of the significant covert operations have been approved by the appropriate NSC committee. At the same time, the Committee notes that approval outside the Agency does not solve all problems since the NSC committees have approved (and in some cases *initiated*) projects that involved highly improper practices or were inconsistent with declared foreign policies.

Approximately three-fourths of all covert action projects are never reviewed or approved by a high level body outside the CIA.²⁸ These projects which are not brought before the NSC for review are so-called "non-sensitive" projects, or part of what the CIA calls its "operational infrastructure." The Committee found that a single small project, though not reviewed by the NSC, still can be of great importance (e.g. QJWIN, the CIA "executive action" assassination capability, and AMLASH, the Cuban officer being groomed to kill Fidel Castro). Moreover, a cluster of small projects can be aggregated to form a program of significance (e.g., Chile).

Until recently, Congress, through its committees, has failed to effectively oversee CIA covert action. Much of this flowed from the legitimate desire of the congressional oversight committees to maintain the security of covert action projects, but it also resulted from a hesitancy to challenge the President or to become directly involved in projects he deemed necessary. Covert paramilitary operations pose a special problem, since they cut across several functions (and committee jurisdictions) of Congress—namely, granting military assistance and making war.

Members of the congressional oversight committees are almost totally dependent on the executive branch for information on covert operations. The secrecy needed for these covert operations allows the executive to limit the information provided to the Congress and to use covert actions to avoid the open scrutiny and debate of the normal foreign policy procedures. While the Committee believes that the

²⁸ Since 1974, the President has had to certify all covert actions as important to the national security—treating smaller projects by certain broad categories.

executive should continue to have the initiative in formulating covert action, it also strongly believes that the appropriate oversight bodies of Congress should be fully informed prior to the initiation of such actions.

Congressional power over the purse can serve as the most effective congressional oversight tool if there is the courage and the will to exercise it. In addition to the regular budget for covert action, the Agency draws on a Contingency Reserve Fund for unanticipated projects. Any withdrawals from this fund require approval from the Office of Management and Budget and notification, within 48 hours, to the appropriate congressional committees. The Committee believes that the Contingency Fund can also provide one of the mechanisms by which Congress can effectively control covert action.

Recommendations

35. The legislation establishing the charter for the Central Intelligence Agency should specify that the CIA is the only U.S. Government agency authorized to conduct covert actions. The purpose of covert actions should be to deal with grave threats to American security. Covert actions should be consistent with publicly-defined United States foreign policy goals, and should be reserved for extraordinary circumstances when no other means will suffice. The legislation governing covert action should require executive branch procedures which will ensure careful and thorough consideration of both the general policies governing covert action and particular covert action projects; such procedures should require the participation and accountability of highest level policymakers.

36. The Committee has already recommended, following its investigation of alleged assassination attempts directed at foreign leaders, a statute to forbid such activities. The Committee reaffirms its support for such a statute and further recommends prohibiting the following covert activities by statute:

- All political assassinations.²⁹
- Efforts to subvert democratic governments.
- Support for police or other internal security forces which engage in the systematic violation of human rights.

37. By statute, the appropriate NSC committee (e.g., the Operations Advisory Group) should review every covert action proposal.³⁰

The Committee recommends that the Operations Advisory Group review include:

- A careful and systematic analysis of the political premises underlying the recommended actions, as well as the nature, extent, purpose, risks, likelihood of success, and costs of the operation. Reasons explaining why the objective can-

²⁹ The Committee endorses Executive Order 11905, of February 18, 1976, which states: "No employee of the United States Government shall engage in, or conspire to engage in, political assassination."

³⁰ Executive Order 11905, 2/18/76, established the Operations Advisory Group and directed it to "consider and develop a policy recommendation, including any comments, for the President prior to his decision on each special activity [e.g., covert operations] in support of national foreign policy objectives."

not be achieved by overt means should also be considered. —Each covert action project should be formally considered at a meeting of the OAG, and if approved, forwarded to the President for final decision. The views and positions of the participants would be fully recorded. For the purpose of OAG, presidential, and congressional considerations, all so-called non-sensitive projects should be aggregated according to the extraordinary circumstances or contingency against which the project is directed.

38. By statute, the intelligence oversight committee(s) of Congress should require that the annual budget submission for covert action programs be specified and detailed as to the activity recommended. Unforeseen covert action projects should be funded from the Contingency Reserve Fund which could be replenished only after the concurrence of the oversight and any other appropriate congressional committees. The congressional intelligence oversight committees should be notified prior to any withdrawal from the Contingency Reserve Fund.

39. By statute, any covert use by the U.S. Government of American citizens as combatants should be preceded by the notification required for all covert actions. The statute should provide that within 60 days of such notification such use shall be terminated unless the Congress has specifically authorized such use. The Congress should be empowered to terminate such use at any time.³¹

40. By statute, the executive branch should be prevented from conducting any covert military assistance program (including the indirect or direct provision of military material, military or logistics advice and training, and funds for mercenaries) without the explicit prior consent of the intelligence oversight committee(s) of Congress.

G. REORGANIZATION OF THE INTELLIGENCE COMMUNITY

1. *The Position of the DCI*

The Committee recommendations regarding the Director of Central Intelligence (pages 43-45) would, if implemented, increase his authority over the entire intelligence community. Given such increased authority, the Committee believes that both the executive branch and the intelligence oversight committee(s) of Congress should give careful consideration to removing the DCI from direct management responsibility for the Central Intelligence Agency. This would free the DCI to concentrate on his responsibilities with regard to the entire intelligence community and would remove him from any conflict of interest in performing that task. It might also increase the accountability of the Central Intelligence Agency by establishing a new and separate senior position—a Director of the Central Intelligence Agency—responsible for only the CIA.

2. *The Structures of the CIA*

The Committee believes that several important problems uncovered in the course of this inquiry suggest that serious consideration also be given to major structural change in the CIA—in particular, sepa-

³¹ This recommendation parallels the current provisions of the War Powers Resolution which could be so amended. (Appendix C, Hearings, Vol. 7, p. 226.)

rating national intelligence production and analysis from the clandestine service and other collection functions. Intelligence production could be placed directly under the DCI, while clandestine collection of foreign intelligence from human and technical sources and covert operations would remain in the CIA.

The advantages of such a step are several:

- The DCI would be removed from the conflict of interest situation of managing the intelligence community as a whole while also directing a collection agency.
- The concern that the DCI's national intelligence judgments are compromised by the impulse to justify certain covert action operations or by the close association of the analysts with the clandestine service would be remedied.
- The problem, seen by some in the intelligence community, of bias on the part of CIA analysts toward the collection resources of the CIA would be lessened.
- It would facilitate providing the intelligence production unit with greater priority and increased resources necessary for improving the quality of its finished intelligence.
- Tighter policy control of the Clandestine Service by the National Security Council and the Department of State would be possible.
- The Director would be able to focus increased attention on monitoring Clandestine Services.
- Internal reorganization of the Directorate for Intelligence and the remainder of the CIA could be facilitated.

There are potential drawbacks as well:

- The Director of Central Intelligence might lose the influence that is part of having command responsibility for the clandestine services.
- The increasing, though still not extensive, contact between national intelligence analysts and the Clandestine Service for the purpose of improving the espionage effort might be inhibited.
- The DCI would have managerial responsibility over the former CIA analysts which might place him in a conflict-of-interest situation in regard to the production of intelligence.
- The increased number of independent agencies would increase the DCI's coordination problems.
- If the clandestine services did not report to the DCI, there would be the problem of establishing an alternative chain of command to the President.
- The Clandestine Service might be downgraded and fail to secure adequate support.

Nonetheless, on balance, the Committee believes such a separation of functions and consequent possible realignments in authority within the intelligence community merit serious consideration.

Recommendations

41. The intelligence oversight committee(s) of Congress in the course of developing a new charter for the intelligence community should give consideration to separating the functions of the DCI and the Director of the CIA and to dividing the intelligence analysis and production functions from the clandestine collection and covert action functions of the present CIA.

H. RELATIONS WITH UNITED STATES INSTITUTIONS AND PRIVATE CITIZENS

In the immediate postwar period, as the communists pressed to influence and to control international organizations and movements, mass communications, and cultural institutions, the United States responded by involving American private institutions and individuals in the secret struggle over minds, institutions, and ideals. In the process, the CIA subsidized, and even helped develop "private" or non-government organizations that were designed to compete with communists around the world. The CIA supported not only foreign organizations, but also the international activities of United States student, labor, cultural, and philanthropic organizations.

These covert relationships have attracted public concern and this Committee's attention because of the importance that Americans attach to the independence of these institutions.

The Committee found that in the past the scale and diversity of these covert actions has been extensive. For operational purposes, the CIA has:

- Funded a special program of a major American business association;
- Collaborated with an American trade union federation;
- Helped to establish a research center at a major United States university;
- Supported an international exchange program sponsored by a group of United States universities;
- Made widespread use of philanthropic organizations to fund such covert action programs.

The Committee's concern about these relationships is heightened by the Agency's tendency to move from support to use of both institutions and individuals. For example, the initial purpose of the Agency's funding of the National Student Association was to permit United States students to represent their own ideas, in their own way, in the international forums of the day. Nevertheless, the Committee has found instances in which the CIA moved from general support to the "operational use" of individual students.³² Contrary to the public's understanding, over 250 United States students were sponsored by the CIA to attend youth festivals in Moscow, Vienna and Helsinki and

³² Operational use, according to CIA directives, means performing services in support of the CIA Operations Directorate, and may include the recruitment, utilization, or training of any individual for such purposes as providing cover and collecting intelligence.

used for missions such as reporting on Soviet and Third World personalities or observing Soviet security practices. The CIA also used National Student Association Summer International Seminars in the United States in the 1950s and 1960s to identify and screen new leaders whom they would eventually support at the national NSA Convention.

When the CIA's relationship to NSA was publicly revealed in 1967, the Johnson Administration established the Katzenbach Committee, with a limited mandate to investigate the relationship of the CIA to "U.S. educational and private voluntary organizations which operate abroad." The Katzenbach Committee recommended that it should be the policy of the United States Government not to provide any "covert financial assistance or support, direct or indirect, to any of the nation's educational or private voluntary organizations."

The Committee found that the CIA not only carried out this Katzenbach recommendation but also terminated support for a number of other U.S.-based organizations such as publishing houses. Nevertheless, the CIA, with the approval of the appropriate NSC committee, insured the continuation of a number of high priority operations by either moving them overseas or encouraging private and non-CIA government support of domestically-based operations. More importantly, however, the CIA shifted its operational interest from institutional relationships to individuals in, or affiliated with, private institutions.

The Committee inquiry has been particularly concerned about the current operational use of United States citizens as individuals. Some academics now help the CIA by providing leads and, on occasion, making introductions to potential sources of foreign intelligence. American academics and freelance writers are occasionally used abroad to assist the CIA's clandestine mission.

1. Covert Use of the U.S. Academic Community

The Central Intelligence Agency is now using several hundred American academics,³³ who in addition to providing leads and sometimes making introductions for intelligence purposes, occasionally write books and other material to be used for propaganda purposes abroad. Beyond these, an additional few more are used in an unwitting manner for minor activities.

These academics are located in over 100 American colleges, universities, and related institutes. At the majority of institutions, no one other than the individual academic concerned is aware of the CIA link. At the others, at least one university official is aware of the operational use made of academics on his campus. In addition, there are several American academics abroad who serve operational purposes, primarily the collection of intelligence.

The CIA gives a high priority to obtaining leads on potential foreign intelligence sources especially those from communist countries. This Agency's emphasis reflects the fact that many foreign nationals in the United States are in this category. The Committee notes that American academics provide valuable assistance in this activity.³⁴

³³ "Academics" includes administrators, faculty members, and graduate students engaged in teaching.

³⁴ For explanation of italics, see footnote, p. 70.

The Committee is concerned, however, that American academics involved in such activities may undermine public confidence that those who train our youth are upholding the ideals, independence, and integrity of American universities.

Government Grantees

CIA regulations adopted in 1967 prohibit the "operational" use of certain narrow categories of individuals. The CIA is prohibited from using teachers, lecturers, and students receiving grants from the Board of Foreign Fellowships under the Fulbright-Hayes Act.³⁴ There is no prohibition on the use of individuals participating in any other federally funded exchange programs. For example, the CIA may use those grantees—artists, specialists, athletes, leaders, etc.—who do not receive their grants from the Board of Foreign Scholarships. The Committee is concerned that there is no prohibition against exploiting such open federal programs for clandestine purposes.³⁵

2. The Covert Use of Books and Publishing Houses

The Committee has found that the Central Intelligence Agency attaches a particular importance to book publishing activities as a form of covert propaganda. A former officer in the Clandestine Service stated that books are "the most important weapon of strategic (long-range) propaganda." Prior to 1967, the Central Intelligence Agency sponsored, subsidized, or produced over 1,000 books; approximately 25 percent of them in English. In 1967 alone, the CIA published or subsidized over 200 books, ranging from books on African safaris and wild-life to translations of Machiavelli's *The Prince* into Swahili and works of T. S. Eliot into Russian, to a competitor to Mao's little red book, which was entitled *Quotations from Chairman Liu*.

The Committee found that an important number of the books actually produced by the Central Intelligence Agency were reviewed and marketed in the United States:

- A book about a young student from a developing country who had studied in a communist country was described by the CIA as "developed by [two areas divisions] and produced by the Domestic Operations Division. . . and has had a high impact in the United States as well as in the [foreign area] market." This book, which was produced by the European outlet of a United States publishing house was published in condensed form in two major U.S. magazines.³⁶
- Another CIA book, *The Penkovsky Papers*, was published in United States in 1965. The book was prepared and written by witting agency assets who drew on actual case materials and publication rights to the manu-

³⁴ CIA regulations also prohibit the operational use of members of ACTION and officials, employees, and grantees of the Ford, Rockefeller, and Carnegie Foundations.

³⁵ For explanation of italics, see footnote, p. 79.

³⁶ CBS commentator Eric Sevareid, in reviewing this book, spoke a larger truth than he knew when he suggested that "our propaganda services could do worse than flood [foreign] university towns with this volume."

script were sold to the publisher through a trust fund which was established for the purpose. The publisher was unaware of any U.S. Government interest.

In 1967, the CIA stopped publishing within the United States. Since then, the Agency has published some 250 books abroad, most of them in foreign languages. The CIA has given special attention to publication and circulation abroad of books about conditions in the Soviet Bloc. Of those targeted at audiences outside the Soviet Union and Eastern Europe, a large number has also been available in English.

3. Domestic "Fallout"

The Committee finds that covert media operations can result in manipulating or incidentally misleading the American public. Despite efforts to minimize it, CIA employees, past and present, have conceded that there is no way to shield the American public completely from "fallout" in the United States from Agency propaganda or placements overseas. Indeed, following the Katzenbach inquiry, the Deputy Director for Operations issued a directive stating: "Fallout in the United States from a foreign publication which we support is inevitable and consequently permissible."

The domestic fallout of covert propaganda comes from many sources: books intended primarily for an English-speaking foreign audience; CIA press placements that are picked up by an international wire service; and publications resulting from direct CIA funding of foreign institutes. For example, a book written for an English-speaking foreign audience by one CIA operative was reviewed favorably by another CIA agent in the *New York Times*. The Committee also found that the CIA helped create and support various Vietnamese periodicals and publications. In at least one instance, a CIA supported Vietnamese publication was used to propagandize the American public and the members and staff of both houses of Congress. So effective was this propaganda that some members quoted from the publication in debating the controversial question of United States involvement in Vietnam.

The Committee found that this inevitable domestic fallout was compounded when the Agency circulated its subsidized books in the United States prior to their distribution abroad in order to induce a favorable reception overseas.

The Covert Use of U.S. Journalists and Media Institutions on February 11, 1976, CIA Director George Bush announced new guidelines governing the Agency's relationship with United States media organizations:

Effective immediately, CIA will not enter into any, paid or contractual relationship with any full-time or part-time news correspondent accredited by any U.S. news service, newspaper, periodical, radio or television network or station.³⁸

³⁸ According to the CIA, "accredited" applies to individuals who are "formally authorized by contract or issuance of press credentials to represent themselves as correspondents." (For explanation of italics, see footnote, p. 170.)

Agency officials who testified after the February 11, 1976, announcement told the Committee that the prohibition extends to non-Americans accredited to specific United States media organizations.

The CIA currently maintains a network of several hundred foreign individuals around the world who provide intelligence for the CIA and at times attempt to influence opinion through the use of covert propaganda. These individuals provide the CIA with direct access to a large number of newspapers and periodicals, scores of press services and news agencies, radio and television stations, commercial book publishers, and other foreign media outlets.

Approximately 50 of the assets are individual American journalists or employees of U.S. media organizations. Of these, fewer than half are "accredited" by U.S. media organizations and thereby affected by the new prohibitions on the use of accredited newsmen. The remaining individuals are non-accredited freelance contributors and media representatives abroad, and thus are not affected by the new CIA prohibition

More than a dozen United States news organizations and commercial publishing houses formerly provided cover for CIA agents abroad. A few of these organizations were unaware that they provided this cover.

The Committee notes that the new CIA prohibitions do not apply to "unaccredited" Americans serving in media organizations such as representatives of U.S. media organizations abroad or freelance writers. Of the more than 50 CIA relationships with United States journalists, or employees in American media organizations, fewer than one half will be terminated under the new CIA guidelines.

The Committee is concerned that the use of American journalists and media organizations for clandestine operations is a threat to the integrity of the press. All American journalists, whether accredited to a United States news organization or just a stringer, may be suspects when any are engaged in covert activities.³⁹

4. Covert Use of American Religious Personnel

The Committee has found that over the years the CIA has used very few religious personnel for operational purposes. The CIA informed the Committee that only 21 such individuals have ever participated in either covert action projects or the clandestine collection of intelligence. On February 11, 1976, the CIA announced:

CIA has no secret paid or contractual relationships with any American clergyman or missionary. This practice will be continued as a matter of policy.

The Committee welcomes this policy with the understanding that the prohibition against all "paid or contractual relationships" is in fact a prohibition against any operational use of all Americans following a religious vocation.

Recommendations

In its consideration of the recommendations that follow, the Committee noted the Central Intelligence Agency's concern that further restriction on the use of Americans for operational purposes will con-

³⁹ For explanation of italics, see footnote, p. 170.

strain current operating programs. The Committee recognizes that there may be at least some short-term operational losses if the Committee recommendations are effected. At the same time, the Committee believes that there are certain American institutions whose integrity is critical to the maintenance of a free society and which should therefore be free of any unwitting role in the clandestine service of the United States Government.

42. The Committee is concerned about the integrity of American academic institutions and the use of individuals affiliated with such institutions for clandestine purposes. Accordingly, the Committee recommends that the CIA amend its internal directives to require that individual academics used for operational purposes by the CIA, together with the President or equivalent official of the relevant academic institutions, be informed of the clandestine CIA relationship.⁴¹

43. The Committee further recommends that, as soon as possible, the permanent intelligence oversight committee(s) of Congress examine whether further steps are needed to insure the integrity of American academic institutions.

44. By statute, the CIA should be prohibited from the operational use of grantees who are receiving funds through educational and/or cultural programs which are sponsored by the United States Government.

45. By statute, the CIA should be prohibited from subsidizing the writing, or production for distribution within the United States or its territories, of any book, magazine, article, publication, film, or video or audio tape unless publicly attributed to the CIA. Nor should the CIA be permitted to undertake any activity to accomplish indirectly such distribution within the United States or its territories.

46. The Committee supports the recently adopted CIA prohibitions against any paid or contractual relationship between the Agency and U.S. and foreign journalists accredited to U.S. media organizations. The CIA prohibitions should, however, be established in law.

47. The Committee recommends that the CIA prohibitions be extended by law to include the operational use of any person who regularly contributes material to, or is regularly involved directly or indirectly in the editing of material, or regularly acts to set policy or provide direction to the activities of U.S. media organizations.

48. The Committee recommends that the Agency's recent prohibition on any paid or contractual relationship between the Agency and any American clergyman or missionary should be established by law.

I. PROPRIETARIES AND COVER

1. Proprietary Organizations

CIA proprietaries are business entities wholly-owned by the Agency which do business, or only appear to do business, under commercial guise. They are part of the "arsenal of tools" of the CIA's

⁴¹ This recommendation is consistent with and would extend section 4(b)(9) of E.O. 11905 which states that CIA sponsorship of classified or unclassified research must be "known to appropriate senior officials of the academic institutions and to senior project officials."

Clandestine Services. They have been used for espionage as well as covert action. Most of the larger proprietaries have been used for paramilitary purposes. The Committee finds that too often large proprietaries have created unwarranted risks of unfair competition with private business and of compromising their cover as clandestine operations. For example, Air America, which at one time had as many as 8,000 employees, ran into both difficulties.

While internal CIA financial controls have been regular and systematic, the Committee found a need for greater accountability both internally and externally. Generally, those auditing the CIA have been denied access to operational information, making management-oriented audits impossible. Instead, audits have been concerned only with financial security and integrity.

The Committee found that the CIA's Inspector General has, on occasion, been denied access to certain information regarding proprietaries. This has sometimes inhibited the ability of the Inspector General's office to serve the function for which it was established. Moreover, the General Accounting Office has not audited these operations. The lack of review, by either the GAO or the CIA Inspector General's office, means that, in essence, there has been no outside review of proprietaries.

One of the largest current proprietaries is an insurance-investment complex established in 1962 to provide pension annuities, insurance and escrow management for those who, for security reasons, could not receive them directly from the U.S. Government. The Committee determined that the Congress was not informed of the existence of this proprietary until "sometime" after it had been made operational and had invested heavily in the domestic stock markets—a practice the CIA has discontinued. Moreover, once this proprietary was removed from the Domestic Operations Division and placed under the General Counsel's office it received no annual CIA project review.

The record establishes that on occasion the insurance-investment complex had been used to provide operational support to various covert action projects. The Inspector General, in 1970, criticized this use of the complex because it threatened to compromise the security of the complex's primary insurance objectives.

In general, the Committee found that when the CIA sought to dispose of or dissolve a proprietary, considerable effort was made to avoid conflicts of interest. However, pressures were sometimes unsuccessfully brought to bear on the CIA from without, and on one or more occasions from high level Agency officials to do a favor by disposing of an entity in a manner that would benefit a particular party. In this connection, the Committee notes that the CIA is not subject to the provisions of the Federal Disposal of Property Act which ordinarily guards against such pressures.

Management and control of proprietaries frequently required, and still do, what is termed "cooperative interface" with other government agencies, such as the SEC and the IRS. The Committee found no evidence that these relationships involved circumventing statutory or regulatory requirements. Their purpose appears to be to enable the Agency to comply with other agencies' requirements in a secure manner. However, the nature and extent of such "interfacing" has not always been completely recorded in the CIA, making it difficult to ensure the propriety of such relationships.

2. Cover

The Committee examined cover because it is an important aspect of all CIA clandestine activities. Its importance is underscored by the tragic murder of a CIA Station Chief in Greece, coupled with continuing disclosures of CIA agents' names. The Committee sought to determine what, if anything, has been done in the past to strengthen cover, and what should be done in the future.

The Committee found conflicting views about what constitutes cover, what it can do, and what should be done to improve it. A 1970 CIA Inspector General report termed the Agency's concept and use of cover to be lax, arbitrary, uneven, confused, and loose. The present cover staff in the CIA considered the 1970 assessment to be simplistic and overly harsh. There is no question, however, that some improvements and changes are needed.

The Committee finds that there is a basic tension between maintaining adequate cover and effectively engaging in overseas intelligence activities. Almost every operational act by a CIA officer under cover in the field—from working with local intelligence and police to attempting to recruit agents—reveals his true purpose and chips away at his cover. Some forms of cover do not provide concealment but offer a certain degree of deniability. Others are so elaborate that they limit the amount of work an officer can do for the CIA. In carrying out their responsibilities, CIA officers generally regard the maintenance of cover as a "nuisance."

The situation of the Athens Station Chief, Richard Welch, illustrates the problem of striking the right balance between cover and operations, and also the transparency of cover. As the Chief of the CIA's Cover Staff stated, by the time a person becomes Chief of Station, "there is not a great deal of cover left."⁴² The Chief of the Cover Staff identified terrorism as a further security problem for officers overseas, one that is aggravated by the erosion of cover.⁴³

Recommendations

49. By statute, the CIA should be permitted to use proprietaries subject to external and internal controls.

50. The Committee recommends that the intelligence oversight committee(s) of Congress require at least an annual report on all proprietaries. The report should include a statement of each proprietary's nature and function, the results of internal annual CIA audits, a list of all CIA intercessions on behalf of its proprietaries with any other United States Government departments, agencies or bureaus, and such other information as the oversight committee deems appropriate.

51. The intelligence oversight committee(s) of Congress should require that the fiscal impact of proprietaries on the CIA's budget be made clear in the DCI's annual report to the oversight committee. The Committee should also establish guidelines for creating large proprietaries, should these become necessary.

⁴² For example, the CIA was concerned about the fact that the home that Mr. Welch moved into had been previously publicly identified as belonging to the former Station Chief. CIA officials have testified that the Agency has no evidence that the recent congressional inquiries into intelligence activities had any adverse impact on Mr. Welch's cover or any relationship to his tragic death. (George Bush testimony, 4/8/70, p. 41.)

⁴³ For explanation of italics, see footnote, p. 170.

52. By statute, all returns of funds from proprietaries not needed for its operational purposes or because of liquidation or termination of a proprietary, should be remitted to the United States Treasury as Miscellaneous Receipts.

The Department of Justice should be consulted during the process of the sale or disposition of any CIA proprietary.

53. By statute, former senior government officials should be prohibited from negotiating with the CIA or any other agency regarding the disposal of proprietaries. The intelligence oversight committee(s) of Congress should consider whether other activities among agencies of the intelligence community, the CIA, and former officials and employees, such as selling to or negotiating contracts with the CIA, should also be prohibited as is the case regarding military officials under 18 U.S.C. 207.

J. INTELLIGENCE LIAISON

Throughout the entire period of the CIA's history, the Agency has entered into liaison agreements with the intelligence services of foreign powers. Such arrangements are an extremely important and delicate source of intelligence and operational support. Intelligence channels can also be used to negotiate agreement outside the field of intelligence. The Committee notes that all treaties require the advice and consent of the Senate, and executive agreements must be reported to the Foreign Relations Committee of the Senate. Because of the importance of intelligence liaison agreements to national security, the Committee is concerned that such agreements have not been systematically reviewed by the Congress in any fashion.

Recommendations

54. By statute, the CIA should be prohibited from causing, funding, or encouraging actions by liaison services which are forbidden to the CIA. Furthermore, the fact that a particular project, action, or activity of the CIA is carried out through or by a foreign liaison service should not relieve the Agency of its responsibilities for clearance within the Agency, within the executive branch, or with the Congress.

55. The intelligence oversight committee(s) of Congress should be kept fully informed of agreements negotiated with other governments through intelligence channels.

K. THE GENERAL COUNSEL AND INSPECTOR GENERAL

The General Counsel, as chief legal officer of the Central Intelligence Agency, has a special role in insuring that CIA activities are consistent with the Constitution and laws of the United States. The Committee found that, in the past, the participation of the General Counsel in determining the legality or propriety of CIA activities was limited; in many instances the General Counsel was not consulted about sensitive projects. In some cases the Director's investigative arm, the Inspector General, discovered questionable activities that often were not referred to the General Counsel for a legal opinion. Moreover, the General Counsel never had general investigatory authority.

The Inspector General not only serves as the Director's investigative arm, but he also aids the Director in attempts to increase the efficiency of Agency activities. Inspector General investigations of various Agency offices (component surveys) have been an important management tool often leading to the discovery of questionable practices. These component surveys were halted in 1973 but have recently been reinstated.

The Committee found that there were problems with the component surveys. In some situations the Inspector General was denied access to essential information. The surveys often failed to effectively cover sensitive programs cutting across component boundaries or raising issues which affected the Agency as a whole. Finally, the Inspector General's recommendations were often disregarded particularly when the directorate being investigated opposed their implementation.

Under the President's recently issued Executive Order, the Inspector General and the General Counsel are required to report to the Intelligence Oversight Board any activities that come to their attention which raise questions of legality or propriety. The Director of the CIA is charged with assuring that those officials will have access to the information necessary to fulfill their duties under the Executive Order.

The Committee also found that while both the General Counsel and Inspector General provided valuable assistance to the Director, neither had authority to provide assistance to the congressional oversight bodies.

The Committee believes that the intelligence oversight committee(s) of Congress should examine the internal review mechanisms of foreign and military intelligence agencies and consider the feasibility of applying recommendations such as those suggested for the CIA.

Recommendations

56. Any CIA employee having information about activities which appear illegal, improper, outside the Agency's legislative charter, or in violation of Agency regulations, should be required to inform the Director, the General Counsel, or the Inspector General of the Agency. If the General Counsel is not informed, he should be notified by the other officials of such reports. The General Counsel and the Inspector General shall, except where they deem it inappropriate, be required to provide such information to the head of the Agency.⁴⁴

57. The DCI should be required to report any information regarding employee violations of law related to their duties and the results of any internal Agency investigation to the Attorney General.⁴⁵

⁴⁴ The General Counsel and Inspector General should have authority to pass the information to the Attorney General without informing the head of the Agency in extraordinary circumstances, if the employee providing the information so requests and if the General Counsel or the Inspector General deems it necessary.

The Inspector General should also regularly inform Agency employees about grievance procedures.

⁴⁵ See 28 U.S.C. 535.

58. By statute, the Director of the CIA should be required to notify the appropriate committees of the Congress of any referrals made to the Attorney General pursuant to the previous recommendation.⁴⁶

59. The Director of the CIA should periodically require employees having any information on past, current, or proposed Agency activities which appear illegal, improper, outside the Agency's legislative charter, or in violation of the Agency's regulations, to report such information.

60. By statute, the General Counsel and the Inspector General should have unrestricted access to all Agency information and should have the authority to review all of the Agency activities.

61. All significant proposed CIA activities should be reviewed by the General Counsel for legality and constitutionality.

62. The program of component inspections conducted by the Inspector General should be increased, as should the program of surveys of sensitive programs and issues which cut across component lines in the Agency.⁴⁷

63. The Director shall, at least annually, report to the appropriate committees of the Congress on the activities of the Office of the General Counsel and the Office of the Inspector General.⁴⁸

64. By statute, the General Counsel should be nominated by the President and confirmed by the Senate.

65. The Agency's efforts to expand and strengthen the staffs of the General Counsel and Inspector General should be continued.⁴⁹

66. The General Counsel should be promoted to, and the Inspector General should continue to hold executive rank equal to that of the Deputy Directors of the CIA.

⁴⁶ Should the General Counsel or Inspector General determine that it would be inappropriate to notify the Director of an activity that appeared illegal, improper, outside the Agency's legislative charter, or in violation of Agency regulations, the General Counsel or Inspector General would be required to notify the appropriate committees of the Congress.

⁴⁷ The Inspector General's component surveys should consider not only the effectiveness of the component but should also examine the component's compliance with the legislative charter of the Agency, Agency regulations, and the law. The Director should be required to inform the Inspector General as to what actions have been taken on the recommendations made by the Inspector General.

⁴⁸ The report should include: (a) a summary of all Agency activities that raise questions of legality or propriety and the General Counsel's findings concerning these activities; (b) a summary of the Inspector General's investigations concerning any of these activities; (c) a summary of the practices and procedures developed to discover activities that raise questions of legality or propriety; (d) a summary of each component, program or issue survey, including the Inspector General's recommendations and the Director's decisions; (e) a summary of all other matters handled by the Inspector General.

The report should also include discussion of (a) major legal problems facing the Agency; (b) the need for additional statutes; (c) any cases referred to the Department of Justice.

⁴⁹ Efforts to recruit lawyers for the Office of General Counsel from outside the CIA should be increased. Efforts should also be made to provide for rotation of the attorneys in the General Counsel's Office to other governmental positions.

The Inspector General's Office should be staffed by outstanding, experienced officers drawn from inside and outside the Agency. Consideration should be given to establishing a greater number of permanent positions within the Office. Individuals rotated into the Inspector General's Office from another Agency office should not be involved in surveys of offices to which they might return.

The work of both offices would benefit from regular inspections from outside.

L. THE DEPARTMENT OF DEFENSE

The intelligence agencies of the Department of Defense make a major contribution to the development, management, and operation of intelligence systems and to the production of military and technical intelligence information. Additionally, the Department, with its major responsibility for the nation's defense is a major user of finished intelligence. The Committee's inquiry into the Department of Defense intelligence agencies focused on the Department's intelligence budget which comprises over 80 percent of the direct national United States intelligence budget.

The Committee also examined the Defense Intelligence Agency (DIA), the National Security Agency (NSA), and the intelligence activities of the military services. That portion of the investigation of NSA which centered on potential abuses is presented in detail in the Domestic Section of the Committee's report.

1. General Findings and Conclusions

The Committee finds that despite the magnitude of the tasks and the complexity of the relationships, most of the important collection activities conducted by the Defense Department (the reconnaissance and SIGINT systems) are managed relatively efficiently and are generally responsive to the needs of the military services as well as to the policymakers on the national level.

Defense intelligence must respond to a range of consumers—policymakers in Washington, defense and technical analysts, and operational commanders in the field—yet the primary mission of defense intelligence is to supply the armed services with the intelligence necessary for their operations. This overriding departmental requirement creates a major problem in the overall allocation of intelligence resources throughout the intelligence community. In promulgating Executive Order 11905, the Administration has decided on a greater centralization of authority in the Director of Central Intelligence. The Committee notes that this will require some changes in the Secretary of Defense's authority over allocating defense intelligence resources. With regard to intelligence resources management within the Department of Defense, the Committee found that the establishment of a Deputy Secretary of Defense for Intelligence should enable more effective management of defense intelligence resources and help the Defense Department play an appropriate role in the new centralized interagency structure under the Director of Central Intelligence.

Increasingly, technological intelligence systems have grown capable of serving both the interests of national policymakers and planners and of field commanders. Thus, it is often difficult to distinguish between "national" and "tactical" intelligence assets, collection, or production. It is the Committee's view that while the effect of the President's Executive Order giving the DCI more authority will be to bring national intelligence assets and budgets under the DCI's control and guidance, the defense intelligence programs which are tactical

in nature and integral to the military's operational commands should remain under the control of the Secretary of Defense. The precise line drawn between the tactical and military intelligence at any given time will have a significant impact on the definition of national intelligence and on the purview of any oversight committee(s) of Congress.

2. *The Defense Intelligence Agency*

Even though the Defense Intelligence Agency has been the principal agency for the production of intelligence in the Defense Department, Secretaries of Defense and other key DOD officials have frequently looked to other intelligence sources rather than to DIA. For example, Robert McNamara relied heavily on the CIA; Melvin Laird sought analyses from the Defense Department's Directorate of Defense Research and Engineering; and James Schlesinger used a special Net Assessment Group. This tendency of Secretaries of Defense to rely on analytic resources outside of DIA is partly but not entirely, related to dissatisfaction with DIA's performance (see the detailed report on DIA). Another factor is the obvious difference between the role of the Defense Department as *manager* of military intelligence collection systems and the role of the Secretary of Defense as a *consumer* of intelligence products. For example, the Secretary's requirements for political and economic intelligence are considerably different from the intelligence needs of the operating forces and the Joint Chiefs of Staff, who are the primary military customers of DIA.

Historically, DOD has managed the bulk of all technical intelligence collection systems, but the CIA has managed many important national technical collection systems and has been in charge of much of the analytic function and is the primary producer of *national* intelligence. The largest proportion of intelligence needed by the military establishment, however, is *tactical*. Therefore, national intelligence is a secondary mission of DIA. Much of DIA's effort is directed toward producing intelligence needed by the JCS, the Unified and Specified Commands, and force planners and technical analysts in the services. The Secretary of Defense, on the other hand, is equally or more concerned with national intelligence. In this context, it is not surprising that DOD's civilian leadership has complemented DIA's product with analyses from sources in other agencies.

The Committee is of the view that the Secretary of Defense has a continuing need for a strong analytical intelligence capability within the Department of Defense. The Committee found that DIA has met this need better than the service intelligence organizations which preceded it, but that DIA has not fulfilled expectations that it would provide a coordinating mechanism for all defense intelligence activities and information.

The essential problem of the Defense Intelligence Agency was summed up in one study commissioned by the executive branch as "too many jobs and too many masters."⁵⁰ These problems have not

⁵⁰ The Report to the President and Secretary of Defense on the Department of Defense by the Blue Ribbon Defense Panel (Fitzhugh Report), 7/1/70.

been solved by the reorganizations undertaken thus far, nor has the DIA's existence led to a diminution in the size of the separate military intelligence services that was hoped for.

The Committee finds that the Defense Intelligence Agency faces serious impediments to improving the quality of, and opportunities for, its civilian and military staff. The Agency's personnel and command structure, its lack of high-level grades, and the relatively short tours for military officers are factors which make it difficult for DIA to develop and retain the high-quality analytic personnel essential for a high-quality finished product.

3. The National Security Agency

The National Security Agency is one of the largest and most technically oriented components of the United States intelligence community. Its basic function is collecting and processing foreign communications and signals for intelligence purposes. NSA is also responsible for creating and supervising the cryptography of all United States Government agencies, and has a special responsibility for supervising the military services' cryptologic agencies. Another major responsibility is protecting the security of American communications.

The Committee regards these functions as vital to American security. NSA's capability to perform these functions must be preserved. The Committee notes that despite the fact that NSA has been in existence for several decades, NSA still lacks a legislative charter. Moreover, in its extensive investigation, the Committee has identified intelligence community abuses in levying requirements on NSA and abuses by NSA itself in carrying out its functions. These abuses are detailed in the domestic portion of the Committee report. The Committee finds that there is a compelling need for an NSA charter to spell out limitations which will protect individual constitutional rights without impairing NSA's necessary foreign intelligence mission.

4. Civilian or Military Leadership

DIA and NSA have always been headed by professional military officers. In the case of DIA, Deputy Directors have also been military. This past practice should not stand in the way of appointment of any individuals, whether civilian or military, best qualified to administer these sensitive agencies.

5. Special Issues

Several important issues concerning NSA have been revealed during the course of the Committee's investigation which require regular reviews by both the intelligence oversight committee(s) of Congress and by the executive branch.

- How can the risks involved in the operations of collection systems be balanced against the value of positive intelligence information acquired through those operations?
- How far in the research/development process of collection systems should the competition between agencies continue

before it leads to unwarranted duplication? Should those who develop a system also manage its acquisition and subsequent operation, or should all operations be consolidated, for example, under the Department of Defense?

—How can the technology of advanced intelligence collection systems be better utilized to assist the civilian and domestic agencies of the Government without compromising the principal mission or security of these intelligence systems, or the open character of these portions of American government?

Recommendations

67. In order to implement the Committee's and the President's recommendations for expanding the DCI's resource-allocation responsibility appropriate adjustments should be made in the Secretary of Defense's general authority regarding Defense intelligence activities and in the Department's internal budgeting procedures. At the same time, there should be provision for the transfer to the Secretary of Defense of responsibilities, particularly tasking intelligence agencies, in the event of war.

68. By statute, the intelligence oversight committee(s) of Congress, in consultation with the Executive, should establish a charter for the Defense Intelligence Agency which would clearly define its mission and relationship to other intelligence agencies. The Committee recommends that the charter include the following provisions:

A. In order to encourage close coordination between consumers and producers of national intelligence, DIA should be a part of the Office of the Secretary of Defense, and should report directly to the Deputy Secretary of Defense for Intelligence. A small J-2 staff should be reconstituted to provide intelligence support, primarily of an operational nature, to the Joint Chiefs of Staff. The Secretary of Defense should ensure full coordination and free access to information between the two groups.

B. The Director of the DIA should be appointed by the President and subject to Senate confirmation. Either the Director or Deputy Director of the Agency should be a civilian.

C. The Congress must relieve DIA from certain Civil Service regulations in order to enable the quality of DIA personnel to be upgraded. In addition, more supergrade positions must be provided for civilians in DIA.

69. By statute, a character for the National Security Agency should be established which, in addition to setting limitations on the Agency's operations (see Domestic Subcommittee Recommendations), would provide that the Director of NSA would be nominated by the President and subject to confirmation by the Senate. The Director should serve at the pleasure of the President but not for more than ten years. Either the Director or the Deputy Director should be a civilian.

70. The Department of Defense should centralize the service counterintelligence and investigative activities within the United States in the Defense Investigative Service (DIS) in order to reduce wasteful duplication.

M. THE DEPARTMENT OF STATE AND AMBASSADORS

The Department of State and the Foreign Service have an important role in the intelligence operations of the United States Government. Because of its responsibilities in formulating and conducting U.S. foreign policy, the State Department is a principal customer for intelligence. Abroad, the Foreign Service, operating overtly, is the principal collector of political intelligence and is a major collector of economic intelligence.⁵¹

Because of its foreign policy responsibilities and its worldwide complex of diplomatic and consular installations, the Department of State is the only Washington agency potentially able to oversee other U.S. Government activities abroad—including those of the CIA. In the field, this responsibility clearly falls on the Ambassador by law. Indeed, Ambassadors are the sole mechanism available outside of the CIA itself to assure that NSC decisions are appropriately carried out by the Clandestine Service. The Committee found that the role of the Department of State and the Ambassadors constitute a central element in the control and improvement in America's intelligence operations overseas. However, the Committee also found that Ambassadors are often reluctant to exercise their authority in intelligence matters. The Department has not encouraged them to do so, and the administration has not issued directives to implement existing law covering the authority of Ambassadors.

The Committee found that in general the Department of State exercised substantial high-level influence over decisions to undertake major covert action programs. In the field, Ambassadors are generally knowledgeable and often involved in significant covert activities projects. There were, however, notable exceptions, such as the effort to prevent Salvador Allende from coming to power in Chile by means of a military coup which was concealed from the Department, the Secretary of State and the American Ambassador to Chile.

In contrast to covert action, the Committee found that neither the State Department nor U.S. Ambassadors are substantially informed about espionage or counterintelligence activities directed at foreign governments. Such coordination as exists in this respect is at the initiative of the Central Intelligence Agency and is infrequent. The Committee found that there is no systematic assessment outside the CIA of the risks of foreign espionage and counterespionage operations and the extent to which those operations conform with overall foreign policy.

In general, Ambassadors in the field are uninformed about specific espionage activities within their countries of assignment. Unlike the case of covert action, Ambassadors are not asked to appraise the risks of espionage activities, nor to assess their benefits. Often Ambassadors do not want to know the specifics of such operations, and what coordination as exists in their cases is based on a general injunction from them to the Station Chiefs that they not be confronted with any "surprises."

⁵¹ The Department has often indicated in budget documents relating to intelligence as having a budget of \$10 million, particularly for the Bureau of Intelligence and Research. However, the intelligence community staff estimates the costs attributable to the function of overt intelligence collection by the Foreign Service at \$80 million.

That is not always enough if an Ambassador wishes to participate in policy decisions. For example, a shift of resources toward recruitment of internal targets in a Western country was under consideration between Washington and the field, and the U.S. Ambassador had not been informed. In this connection, the Committee believes it would be unrealistic to use clandestine recruitment to try to establish the kind of intimate relationship with political elites in friendly countries which we have enjoyed as a result of the shared experience of WWII and its aftermath.

The Committee finds that more than a year after enactment of a statute making Ambassadors responsible for directing, coordinating, and supervising all U.S. Government employees within their country of assignment,²² instructions implementing this law have still not been issued by any quarter of the executive branch. A former Under Secretary of State told the Committee that the law, in effect, had been "suspended" in view of Presidential inaction. Moreover, the CIA has not modified its practices pursuant to this law. The Committee finds this thwarting of the United States law unacceptable.

The Committee finds that Ambassadors cannot effectively exercise their legal responsibilities for a wide variety of intelligence activities within their jurisdiction without State Department assistance on the Washington aspects of the activities. Such support is particularly important in the case of intelligence operations aimed at a third country. An Ambassador may be able to judge the local risks of an espionage effort, but if it is directed toward a third country the Ambassador may not be able to assess the importance or value of the effort without Washington support.

In the past, the Department of State, at least, has not had a parallel responsibility nor the right of access to information necessary to enable it to provide support to an Ambassador seeking to exercise his statutory responsibility over CIA espionage and counterespionage operations. The Committee notes section 4 in Executive Order No. 11905 of February 18, 1976 which may be intended to provide such State Department back-up for Ambassadors.

At present, the CIA handles both State Department and its own communications with overseas posts. Under this arrangement, the Ambassador's access to CIA communications is at the discretion of the CIA. The Committee finds that this is not compatible with the role assigned to the Ambassador by law; the Ambassador cannot be sure that he knows the full extent and nature of CIA operations for which he may be held accountable.

The Committee finds that Ambassadors' policies governing intelligence activities have sometimes been interpreted in a manner which vitiated their intent. For example, one Ambassador prohibited any electronic surveillance by his Embassy's CIA component. The head of the CIA component interpreted this to proscribe only CIA electronic surveillance and believed that such surveillance could be conducted in cooperation with local security services.

²² 22 U.S.C. 2680a. The instructions prepared by the State Department and forwarded to the NSC have been opposed by the CIA on the grounds that the CIA still has a responsibility to protect sources and methods from unauthorized disclosure. The NSC has not acted on the proposed instructions.

The Committee found evidence that CIA Station Chiefs abroad do not always coordinate their intelligence reporting on local developments with their Ambassadors. The Committee does not believe that Ambassadors should be able to block CIA field reports. However, it found that there was no standard practice for Ambassadors to review and comment on intelligence reporting from the field.

The Committee finds that the Foreign Service is the foremost producer in the United States Government of intelligence on foreign political and economic matters. The Committee believes, however, that the State Department does not adequately train Foreign Service personnel, particularly in political reporting. Nor does the Department fund their collection operations, nor manage their activities so as to take full advantage of this extremely important intelligence capability. In effect, the Department, despite being a major source of intelligence, considers this function secondary to its principal task of diplomatic representation and negotiations.

From discussions in nearly a dozen foreign service posts, the Committee established that there is inadequate funding for Foreign Service reporting officers to carry out their responsibilities. The funds available are considered "representation funds" and must be shared with the administration and consular sections of most embassies. Such representation funds have been a favorite target for congressional cuts in the State Department budget.

Recommendations

71. The National Security Council, the Department of State, and the Central Intelligence Agency should promptly issue instructions implementing Public Law 93-475 (22 U.S.C. 2680a). These instructions should make clear that Ambassadors are authorized recipients of sources and methods information concerning all intelligence activities, including espionage and counterintelligence operations. Parallel instructions from other components of the intelligence community should be issued to their respective field organizations and operatives. Copies of all these instructions should be made available to the intelligence oversight committee(s) of Congress.

72. In the exercise of their statutory responsibilities, Ambassadors should have the personal right, which may not be delegated, of access to the operational communications of the CIA's Clandestine Service in the country to which they are assigned. Any exceptions should have Presidential approval and should be brought to the attention of the intelligence oversight committee(s) of Congress.

73. By statute, the Department of State should be authorized to take the necessary steps to assure its ability to provide effective guidance and support to Ambassadors in the execution of their responsibilities under Public Law 93-475 (22 U.S.C. Sect. 2680a).

74. Consideration should be given to increasing and earmarking funds for Foreign Service overt collection of foreign political and economic information. These funds might be administered jointly by the State Department's Bureau of Intelligence and Research and the Bureau of Economic Affairs.

75. The NSC should review the question of which U.S. Government agency should control and operate communications with over-

seas diplomatic and consular posts, including the CIA, and other civilian agencies operating abroad.

76. The Department of State should establish specific training programs for political reporting within the Foreign Service Institute, and place greater emphasis on economic reporting.

N. OVERSIGHT AND THE INTELLIGENCE BUDGET

The Committee finds that a full understanding of the budget of the intelligence community is required for effective oversight. The secrecy surrounding the budget, however, makes it impossible for Congress as a whole to make use of this valuable oversight tool.

Congress as a body has never explicitly voted on a "budget" for national intelligence activities. Congress has never voted funds specifically for CIA, NSA, and other national intelligence instrumentalities of the Department of Defense.⁵⁴

The funding levels for these intelligence agencies are fixed by subcommittees of the Armed Services and Appropriations Committees of both Houses. Funds for these agencies are then concealed in the budget of the Department of Defense. Since this Departmental budget is the one Congress approves, Congress as a whole, and the public, have never known how much the intelligence agencies are spending or how much is spent on intelligence activities generally. Neither Congress as a whole, nor the public can determine whether the amount spent on intelligence, or by the intelligence agencies individually, is appropriate, given the priorities.

Because the funds for intelligence are concealed in Defense appropriations, those appropriations are thereby inflated. Most members of Congress and the public can neither determine which categories are inflated nor the extent to which funds in the inflated categories are being used for purposes for which they are approved.

Finally, the Committee believes there is serious question as to whether the present system of complete secrecy violates the constitutional provision that:

No Money shall be drawn from the Treasury out in Consequence of Appropriations made by Law; and a regular Statement and Account of the Receipts and Expenditures of all public Money shall be published from time to time.⁵⁵

The Committee believes that the overall figure for national intelligence activities can be made public annually without endangering national security or revealing sensitive programs.⁵⁶ The Committee carefully examined the possible impact of such disclosure on the sources and methods of intelligence gathering and believes it to be minimal. The Committee found that the primary concern about this

⁵⁴ Funds for the intelligence activities of the Department of State, ERDA, and the FBI are reviewed by the appropriate congressional committees and are voted upon by Congress as a whole, when Congress appropriates funds for these agencies.

⁵⁵ United States Constitution, Art. I, Sec. 9 Cls. 7.

⁵⁶ The Committee noted that the Special Senate Committee to Study Questions Related to Secret and Confidential Government Documents, chaired by Senators Mansfield and Scott concluded that the aggregate figure for each intelligence agency should be made public.

level of disclosure was that it would lead to pressure for even more detailed revelation which would compromise vital intelligence programs.

The Committee believes that disclosure of an aggregate figure for national intelligence is as far as it is prudent to go at this stage in reconciling the nation's constitutional and national security requirements. Public speculation about overall intelligence costs would be eliminated, the public would be assured that funds appropriated to particular government agencies were in fact intended for those agencies, and both Congress and the public would be able to assess overall priorities in governmental spending.

The Committee's analysis indicated that ----- billion constitutes the direct costs to the United States for its national intelligence program for FY 1976. This includes the total approved budgets of CIA, DIA, NSA and the national reconnaissance program.⁵⁷ If the cost of tactical intelligence by the armed services and indirect support costs⁵⁸ which may be attributed to intelligence and intelligence-related activities is added, the total cost of U.S. Government intelligence activities would be twice that amount. This represents about three percent of the total federal budget, and about eight percent of controllable federal spending.

It should be stressed that this larger estimate represents a full cost and includes activities which also fulfill other purposes. Thus the entire amount could not be "saved" if there were no intelligence activities funded by or through the Defense Department.

The CIA's budget for the fiscal year is contained in the Defense Department budget. The Committee found that the CIA spends approximately 70 percent more than it is appropriated, with the additional funds coming from advances and transfers from other agencies. These transfers and advances are made with the knowledge and approval of OMB and the appropriate congressional committees. The use of advances and transfers between agencies is a common governmental practice. In this case the CIA receives funds as the contracting agent for agencies in the Defense Department as well as other intelligence community agencies.

Recommendations

77. The intelligence oversight committee(s) of Congress should authorize on an annual basis a "National Intelligence Budget," the total amount of which would be made public. The Committee recommends that the oversight committee consider whether it is necessary, given the Constitutional requirement and the national security demands, to publish more detailed budgets.

78. The intelligence oversight committee(s) of Congress should monitor the tactical and indirect support accounts as well as the national activities of intelligence agencies in order to assure that they are kept in proper perspective and balance.

⁵⁷ The direct costs of the intelligence activities of the ERDA, FBI, and State Department are contained in their respective budgets.

⁵⁸ Indirect support costs include costs for personnel, operations and maintenance which support intelligence activities. Examples are the operation of training facilities, supply bases, and commissaries.

79. At the request of the intelligence oversight committee(s) of Congress and as its agent, staff members of the General Accounting Office should conduct full audits, both for compliance and for management of all components of the intelligence community. The GAO should establish such procedures, compartmentation and clearances as are necessary in order to conduct these audits on a secure basis. In conducting such audits, the GAO should be authorized to have full access to all necessary intelligence community files and records.

O. CHEMICAL AND BIOLOGICAL AGENTS AND THE INTELLIGENCE COMMUNITY

The Committee investigated the testing and use of chemical and biological agents by agencies within the intelligence community. The testing programs originated in response to fears that countries hostile to the United States would use chemical and biological agents against Americans or our allies. Initially, this fear led to defensive programs. Soon this defensive orientation became secondary as the possibility of using these chemical and biological agents to obtain information from, or to gain control of, enemy agents, became apparent.

The Committee found that United States intelligence agencies engaged in research and development programs to discover materials which could be used to alter human behavior. As part of this effort, testing programs were instituted, first involving witting human subjects. Later, drugs were surreptitiously administered to unwitting human subjects.

The Agency considered the testing programs highly sensitive. The Committee found that few people within the agencies knew about them; there is no evidence that Congress was informed about them. These programs were kept from the American public because, as the Inspector General of the CIA wrote, "the knowledge that the Agency is engaging in unethical and illicit activities would have serious repercussions in political and diplomatic circles and would be detrimental to the accomplishment of its [CIA's] mission."

The research and development program and particularly the testing program involving unwitting human subjects involved massive abridgements of the rights of individuals, sometimes with tragic consequences. The deaths of two Americans resulted from these programs; other participants in the testing programs still suffer residual effects. While some controlled testing for defensive purposes might be defended, the nature of the tests, their scale, and the fact that they were continued for years after it was known that the surreptitious administration of LSD to unwitting subjects was dangerous, indicate a disregard for human life and liberty.

The Committee's investigation of the testing and use of chemical and biological agents also raised serious questions about the adequacy of command and control procedures within the CIA. The Committee found that the Director waived the CIA's normal administrative controls for this development and testing program in order to assure its security. According to the head of the CIA's Audit Branch, the waiver produced "gross administrative failures." The waiver prevented the internal review mechanisms of the Agency—the Office

of the General Counsel, the Inspector General, and the Audit Staff—from exercising adequate supervision of the program. The waiver had the paradoxical effect of providing looser administrative controls and less effective internal review of this controversial and highly sensitive project than existed for normal Agency activities.

The Committee found that the security of the program was protected not only by the waiver but also by a high degree of compartmentation within the CIA. This resulted in excluding the CIA's Medical Staff from the principal research and testing program involving the effect of chemical and biological agents on human subjects.

The Committee also found that within the intelligence community there were destructive jurisdictional conflicts over drug testing. Military testers withheld information from the CIA, ignoring their superiors' suggestions for coordination. The CIA similarly failed to provide information on its programs to the military. In one case the military attempted to conceal its overseas operational testing of LSD from the CIA and the CIA attempted surreptitiously to discover the details of the military's program.

Recommendations

80. The CIA and other foreign and foreign military intelligence agencies should not engage in experimentation on human subjects utilizing any drug, device or procedure which is designed, intended, or is reasonably likely to harm the physical or mental health of the human subject, except with the informed consent in writing, witnessed by a disinterested third party, of each human subject, and in accordance with the guidelines issued by the National Commission for the Protection of Human Subjects for Biomedical and Behavioral Research. Further, the jurisdiction of the Commission should be amended to include the Central Intelligence Agency and the other intelligence agencies of the United States Government.

81. The Director of the Central Intelligence Agency and the Secretary of Defense should continue to make determined efforts to locate those individuals involved in human testing of chemical and biological agents and to provide follow-up examinations and treatment, if necessary.

P. GENERAL RECOMMENDATIONS

82. *Internal Regulations*—Internal CIA directives or regulations regarding significant Agency policies and procedures should be waived only with the explicit written approval of the Director of Central Intelligence. Waiver of any such regulation or directive should in no way violate any law or infringe on the constitutional right and freedom of any citizen. If the DCI approves the waiver or amendment of any significant regulation or directive, the NSC and the appropriate congressional oversight committee(s) should be notified immediately. Such notification should be accompanied by a statement explaining the reasons for the waiver or amendment.

83. *Security Clearances*—In the course of its investigation, the Committee found that because of the many intelligence agencies participating in security clearance investigations, current security clearance procedures involve duplication of effort, waste of money, and inconsistent patterns of investigation and standards. The intelli-

gence oversight committee(s) of Congress, in consultation with the intelligence community, should consider framing standard security clearance procedures for all civilian intelligence agencies and background checks for congressional committees when security clearances are required.

84. *Personnel Practices*—The Committee found that intelligence agency training programs fail to instruct personnel adequately on the legal limitations and prohibitions applicable to intelligence activities. The Committee recommends that these training programs should be expanded to include review of constitutional, statutory, and regulatory provisions in an effort to heighten awareness among all intelligence personnel concerning the potential effects intelligence activities may have on citizens' legal rights.

85. *Security Functions of the Intelligence Agencies*—The Committee found that the security components of intelligence agencies sometimes engaged in law enforcement activities. Some of these activities may have been unlawful. Intelligence agencies' security functions should be limited to protecting the agencies' personnel and facilities and lawful activities and to assuring that intelligence personnel follow proper security practices. (See the Committee's Final Report on Domestic Intelligence, section on Intelligence Activities and the Rights of American Citizens, p. 304.)

86. *Secrecy and Authorized Disclosure*—The Committee has received various administration proposals that would require persons having access to classified and sensitive information to maintain the secrecy of that information. The Committee recommends that the issues raised by these proposals be considered by the new legislative intelligence oversight committee(s) of Congress and that, in recasting the 1947 National Security Act and in consultation with the executive branch, the oversight committee(s) consider the wisdom of new secrecy and disclosure legislation. In the view of the Committee any such consideration should include carefully defining the following terms:

- national secret;
- sources and methods;
- lawful and unlawful classification;
- lawful and unlawful disclosure.

The new legislation should provide civil and/or criminal penalties for unlawful classification and unlawful disclosure. The statute should also provide for internal departmental and agency procedures for employees who believe that classification and/or disclosure procedures are being improperly or illegally used to report such belief. There should also be a statutory procedure whereby an employee who has used the Agency channel to no avail can report such belief without impunity to an "authorized" institutional group outside the agency. The new Intelligence Oversight Board is one such group. The intelligence oversight committee(s) of Congress would be another. The statute should specify that revealing classified information in the course of reporting information to an authorized group would not constitute unlawful disclosure of classified information.

87. *Federal Register for Classified Executive Orders*—In the course of its investigation, the Committee often had difficulty locating classi-

fied orders, directives, instructions, and regulations issued by various elements of the executive branch. Access to these orders by the intelligence oversight committee(s) of Congress is essential to informed oversight of the intelligence community.

The Committee recommends that a Federal Register for classified executive orders be established, by statute. The statute should require the registry, under appropriate security procedures, of all executive orders—however they are labeled—concerning the intelligence activities of the United States. Among the documents for which registry in the Classified Federal Register should be required are all National Security Council Intelligence Directives (NSCIDs), and all Director of Central Intelligence Directives (DCIDs). Provision should be made for access to classified executive orders by the intelligence oversight committee(s) of Congress. Classified executive orders would not be lawful until filed with the registry, although there should be provision for immediate implementation in emergency situations with prompt subsequent registry required.

APPENDIX I

CONGRESSIONAL AUTHORIZATION FOR THE CENTRAL INTELLIGENCE AGENCY TO CONDUCT COVERT ACTION

In recent years the CIA has spent millions of dollars in countries all over the world for "covert action." Covert action, as the Central Intelligence Agency has defined it, is any "clandestine activity designed to influence foreign governments, events, organizations, or persons in support of the United States foreign policy conducted in such a manner that the involvement of the U.S. Government is not apparent."¹ In its purpose to influence events, covert action is distinguished from clandestine intelligence gathering—often referred to as espionage.²

In the last several years controversy has surrounded the conduct of covert action by the Central Intelligence Agency. Since covert action is not listed as a mission of the CIA in either its basic charter, the National Security Act of 1947, or in the Central Intelligence Agency Act of 1949, questions arise regarding the authority by which the Agency undertook it. This report addresses the question of congressional authorization for covert action. It does not attempt to analyze the inherent power of the President to make covert action the responsibility of one of the executive branch agencies.

At the outset, it should be noted that Congress is, in part, responsible for the ambiguity which clouds the CIA's authority. The National Security Act was designed to provide flexibility to the newly created CIA so that it could meet unforeseen challenges. Flexibility was provided through an undefined and apparently open-ended grant of authority to the National Security Council, and through it, to the CIA. Without any indication in the Act's history that the Congress anticipated covert action or intended to authorize it, and without any executive branch attempt to obtain from Congress specific authority for the conduct of covert actions such as sabotage or paramilitary activities, the NSC directed CIA to undertake these activities. Until 1974, Congress did not attempt to clarify the Agency's authority in this area, even after learning about such well-publicized covert actions as the invasion of the Bay of Pigs.

An analysis of congressional authorization for the conduct of covert action goes far beyond the study of 30-year-old legislative debates. It provides evidence of changes in the roles of the President and the Congress in the formulation, implementation, and review of foreign policy.

¹ Testimony of Mitchell Rogovin, Special Counsel to the Director of Central Intelligence, House Select Intelligence Committee, 12/9/75, p. 1780. Covert action was originally defined by the National Security Council as "secret action to influence events in foreign countries which is so designed that, if discovered, official U.S. Government participation can be plausibly denied."

² Covert action also differs from clandestine collection and espionage in that the latter are designed to obtain intelligence without affecting the source or revealing the fact that the information has been collected.

It examines the procedures by which the President and the Congress have delegated power to the NSC and the CIA and the effect of those procedures. It illuminates the way the executive branch has interpreted undefined provisions of law. It raises questions about congressional oversight of covert action and particularly the ability of Congress, in the interest of security, to deny itself information. The result of the denial has been to allow small numbers of senior members to exercise the oversight function and to determine how much money the CIA was to receive and for what purposes.

Hopefully, this report will not only be useful to those interested in the past. An examination of the question of congressional authorization for the conduct of covert action may contribute to a better understanding of the relationship between the need for secrecy and the processes of constitutional government. Such an understanding is necessary as the United States moves into its third century.

Before turning to the National Security Act of 1947, two caveats are in order. The first and most important is that any attempt to understand the relationship between Congress and the executive branch in this area must be based on the evidence available, which is often quite sparse. For example, the Select Committee was able to locate the transcript of only one executive session of a congressional committee considering the National Security Act of 1947, although weeks of such sessions were held on this important legislation.

Covert action is now a well-defined and understood term. The second caveat is for the reader to remember that although the U.S. did undertake what would now be called covert action during World War II, the term, and its possible scope, were not clearly understood in the late 1940's.

A. THE NATIONAL SECURITY ACT OF 1947

Although it has been cited as authority for the CIA to engage in covert action, the National Security Act of 1947 does not specifically mention covert action. A review of the hearings, committee reports and floor debates on the Act reveals no substantial evidence that Congress intended by passage of the Act to authorize covert action by the CIA. In addition, a contemporaneous analysis of the Act by the General Counsel of the CIA concluded that Congress had no idea that, under the authority of the National Security Act, the CIA would undertake covert action such as subversion or sabotage.

Congress did intend to provide the newly created CIA with sufficient flexibility so that it would be able to respond to changing circumstances. There is no evidence, however, that that flexibility was intended to allow the creation of a peacetime agency engaged in activities such as paramilitary action or attempted assassination.

Although the evidence strongly suggests that the executive branch did not intend through the language of the National Security Act to obtain authorization from Congress for the conduct of covert action, the record is not absolutely clear. Whether it did or did not so intend, the executive branch soon seized upon the broad language of the Na-

tional Security Act. Facing what was perceived as an extraordinary threat from the Soviet Union and her allies, coming to believe that the only possible course of action for the United States was to respond to covert action with covert action, the NSC authorized the CIA to conduct covert action.

1. Textual Analysis

Nowhere in the National Security Act is covert action specifically authorized. Section 102(d)(5) of the Act, however, has been cited as authority for covert action.⁴ That clause authorizes the CIA to "perform such other functions and duties related to intelligence affecting the national security as the National Security Council may from time to time direct."⁵

This clause was cited in NSC-4-A and NSC 10/2, the early directives from the National Security Council to the Central Intelligence Agency which directed the CIA to conduct covert action.⁶ The Director of the CIA has cited the same section in claiming authorization for covert paramilitary activity.⁷

On its face, the clause might be taken to authorize an enormous range of activities not otherwise specified in the National Security Act.⁸ An important limitation on the authorization, however, is that

⁴ Section 102(d)(4), which authorizes the CIA to "perform for the benefit of existing intelligence agencies, such additional services of common concern as the National Security Council determines can be more efficiently accomplished centrally," appears on its face to be applicable to covert action to the same extent as Section 102(d)(5). Both represent an effort to provide the Agency with some flexibility in intelligence matters. Section 102(d)(4), however, has not been cited by either the NSC or the CIA as authorizing covert action.

A provision similar to Section 102(d)(4) in the Presidential Directive establishing the Central Intelligence Group, the CIA's predecessor agency, was cited as the CIG's authority to engage in clandestine collection of intelligence; Section 102(d)(4) was cited by the National Security Council in directing the CIA to engage in the same activity.

⁵ 50 U.S.C. 403(d)(5).

⁶ While the CIA has consistently invoked the President's power to authorize covert action, neither NSC 4-A or NSC 10/2 mentioned that power; both referred to the authority conveyed by the National Security Act.

⁷ The General Counsel of the CIA wrote the DCI commenting on his testimony before the Subcommittee on Security Agreements and Commitments Abroad of the Senate Committee on Foreign Relations as follows:

"As for the authority of this Agency to engage in [covert paramilitary activity], I think you were probably exactly right to stick to the language of the National Security Act of 1947, as amended, particularly that portion which says that the Agency shall 'perform such other functions and duties related to intelligence affecting the national security as the National Security Council may from time to time direct.' Actually, from 1947 on my position has been that this is a rather doubtful statutory authority on which to hang our paramilitary activities."

(Memorandum from the CIA General Counsel to the Director, Subject: Symington Subcommittee Hearings, 10/30/69.)

⁸ One of the witnesses appearing before the executive session of the House Committee on Expenditures in the Executive Departments on June 27, 1947, described the function of section (d)(5) as being to allow the CIA to go beyond its enumerated functions during an emergency. (Peter Vischer testimony, House Committee on Expenditures in the Executive Departments, Hearings on H.R. 2619, 6/27/47, p. 78.)

the activities must be "related to intelligence affecting the national security." As Clark Clifford told the Senate Select Committee:

You will note that the language of the Act provides that this catch-all phrase is applicable only in the event that the national security is affected. This was considered to be an important and restricting clause.⁹

Some covert actions are at least arguably "related to intelligence affecting the national security." As an individual in the CIA's Office of the General Counsel noted in a memorandum to the General Counsel:

. . . it can be argued that many covert activities assigned to the Agency by the National Security Council are at least "related" to intelligence affecting the national security . . . in the sense that their performance often is intimately dovetailed with clandestine intelligence operations, use the same operations and methods and yield important intelligence results.¹⁰

Not all covert actions, however, have the characteristics suggested in the above quotation. Many covert operations, such as the invasion of the Bay of Pigs, have, at best, only the most limited relationship to intelligence affecting the national security.¹¹ As the General Counsel of the CIA wrote in 1947:

Taken out of context and without knowledge of its history, these Sections [102(d)(4) and (5)] could bear almost unlimited interpretation, provided that the services performed could be shown to be of benefit to an intelligence agency or related to national intelligence.

Thus black propaganda, primarily designed for subversion, confusion, and political effect, can be shown incidentally to benefit positive intelligence as a means of checking reliability of informants, effectiveness of penetration, and so forth. Even certain forms of S.O. [special operations] work could be held to benefit intelligence by establishment of W/T [wireless telegraph] teams in accessible areas, and by opening penetration points in confusion following sabotage or riot. *In our opinion, however, either activity would be an unwarranted extension of the functions authorized in Sections 102(d)(4) and (5).* This is based on our understanding of the intent of Congress at the time these provisions were enacted.¹² [Emphasis added.]

The General Counsel concluded again in 1962 that certain forms of covert action are not "related to intelligence." In a memorandum to the DCI he wrote, "some of the covert cold war operations are related to intelligence within a broad interpretation of Section 102(d)(5). It

⁹ Clark Clifford testimony, 12/4/75, Hearings, Vol VII, p. 51.

¹⁰ Memorandum from the CIA Office of the General Counsel to the General Counsel, 2/6/74, p. 1.

¹¹ The secrecy which surrounded the invasion of the Bay of Pigs may well have interfered with the CIA's mission to correlate and evaluate intelligence related to the national security. Analysts in the Directorate of Intelligence were neither informed about, nor asked to evaluate, the invasion plans.

¹² Memorandum from the CIA General Counsel to the Director, 9/25/47, p. 1.

would be stretching that section too far to include a Guatemala or a Cuba even though intelligence and counterintelligence are essential to such activities."¹² In this same memorandum, the General Counsel suggested that, in order for the National Security Act to provide authority for the conduct of the wide range of covert action engaged in by the CIA, Section 102(d) (5) would have to read, "perform such other functions and duties related to the national security" as the NSC might from time to time direct, and not "perform such other functions and duties related to intelligence affecting the national security."¹⁴ After this interpretation was given by the General Counsel, no attempt was made by the executive branch to have the National Security Act amended.¹⁵

Only the most strained interpretation of "intelligence affecting the national security" would allow certain covert actions by the CIA such as paramilitary activities or the attempted assassination of foreign leaders to come under Section 102(d) (5). As some covert actions are more directly "related to intelligence affecting the national security," however, it is important to examine the legislative history¹⁶ of the Na-

¹²Memorandum from the CIA General Counsel to the Director, 1/15/62, p. 2. While the CIA has recently stated that "intelligence" was intended to have a broader interpretation than the General Counsel indicated in the memorandum. (See Rogovin, HSIC 12/9/75, p. 175) there is no evidence that Congress intended the phrase "related to intelligence" to cover such activities as the attempted assassination of foreign leaders. Under the CIA's expansive interpretation even this would be authorized as the agents involved in the assassination attempt might have previously provided intelligence to the CIA.

¹³General Counsel memorandum, 1/15/62, p. 2

¹⁴In the same memorandum the General Counsel argued that the CIA was authorized by Congress to conduct covert action as "Congress as a whole knows that money is appropriated to CIA and knows that generally a portion of it goes for clandestine activities." Given presidential direction and congressional appropriation he advised that additional statutory authority is "unnecessary and, in view of the clandestine nature of the activities, undesirable." (*Ibid.* p. 3.)

¹⁶Legislative history includes review of the pre-enactment history, including a history of the predecessor agencies, the history of the enactment, and subsequent interpretation of the act. Legislative history is used as an aid to statutory construction where the language of the statute is unclear [*United States v. Donrus Co.*, 393 U.S. 297 (1965); *United States v. Public Utilities Commission, California*, 345 U.S. 205 (1953)], where placing the "plain language" of a particular provision in the context of the whole statute creates an ambiguity [*Mastro Plastic Corp. v. National Labor Relations Board*, 350 U.S. 270 (1956); *Richards v. United States*, 369 U.S. 1 (1962)], or where it can be shown that an application of the literal words would bring about a result plainly at variance with their purpose [*Johansen v. United States*, 343 U.S. 427 (1952); *United States v. Dickerson*, 310 U.S. 554 (1940)]. It is pertinent only to show legislative intent and, thus, the various kinds of legislative history—hearings, reports, floor debates—are considered significant according to the likelihood that they indicate the purpose of the legislature as a whole. For instance, if Congress as a whole is not, or cannot be, aware of the evidence that a bill would have a particular effect, or remedy a particular evil, it cannot be assumed that Congress intended the statute to have that effect. In construing statutes courts will, therefore, consider whether the history manifested in the hearings, reports and floor debates was made available to the legislators, whether they were actually aware of it, and the credence which the legislators themselves may have given to it.

In certain instances, an examination of executive session may illuminate the intent of individual members of Congress. Such testimony might also clarify the Executive's interpretation of a particular piece of legislation.

tional Security Act to determine if these forms of covert action were within the range of activities which Congress intended to authorize or whether they represent what the CIA's former General Counsel called "an unwarranted extension of the functions authorized in Sections 102 (d) (4) and (5)." Congressional intent is particularly important in this instance as Congress required the language of Section 102 to be written into law rather than incorporating an earlier Presidential Directive by reference. This was done because several Members of Congress believed that if the CIA's missions were not set out in the statute, the President could change them at any time simply by amending the Directive.¹⁷

Before turning to the legislative history of the National Security Act, however it is important to note that Section 102(d) (5) sets out a second condition—the CIA must be directed by the NSC to perform the "other functions and duties." The authority of NSC to direct the CIA to undertake activities has recently come under attack.¹⁸ The question of whether the NSC must specifically approve each covert action or whether it can delegate its authority or provide approval in advance for whole categories—or programs—of covert action has also been raised. General Vandenberg, who headed the Central Intelligence Group, the CIA's predecessor body, expressed to the drafters of the National Security Act his belief that the CIA should not have to come continually to the NSC for approval for action. According to a CIA legislative history of the Act, Vandenberg was told that the CIA would need to come to the NSC only on such specific matters as the NSC required.¹⁹

Over time the practice developed that all politically risky or costly covert action projects would be brought before the 40 Committee of the National Security Council, or its predecessors, for approval. However, low-risk projects could be approved within the CIA. During some periods of time only a quarter of all covert action projects undertaken by the CIA—the high-risk, high-cost covert actions—were approved by the NSC 40 Committee.²⁰ In at least one instance, the 40

¹⁷ Hearings before the House Committee on Expenditures in the Executive Department on H.R. 2319, National Security Act of 1947 April–July, 1947, p. 171. See also Transcript, House Committee on Expenditures in the Executive Department, Hearings on H.R. 2319, 6/27/47, pp. 57–58. Another reason given for enumerating the CIA's purpose was that the public would not have access to the *Federal Register* and thus would be ignorant of the Agency's missions.

¹⁸ See Committee on Civil Rights and the Committee on International Rights of the Association of the Bar of the City of New York, "Central Intelligence Agency: Oversight and Accountability," p. 13; and Central Intelligence Agency response to "Central Intelligence Agency: Oversight and Accountability," p. 21.

For a discussion of the President's authority to direct the CIA to undertake various forms of covert action in the absence of congressional authorization, or when Congress has spoken, see chapt. III.

¹⁹ See CIA Legislative Counsel memorandum, "Legislative History of the Central Intelligence Agency: the National Security Act of 1947," 5/25/67, p. 30 (hereinafter cited as "CIA's Legislative History").

²⁰ A 1963 study showed that of the 550 existing covert action projects of the CIA, which according to the CIA's own internal instruction should have been submitted to the Special Group (the 40 Committee's predecessor), only 86 were separately approved (or reapproved) by the Special Group between January 1 and December 1, 1962. Memorandum for the Record, C/CA/PEG, Subject: "Policy Coordination of CIA's Covert Action Operations," 2/21/67.

Committee was not informed about a major covert action—the Track II attempt in Chile to foment a coup.²¹

If Congressional authorization is claimed then the procedures established by Congress must be honored. If Congress intended covert actions to be undertaken on an ad hoc basis as specifically directed by the NSC then that procedure must be followed. As Chief Justice Marshall wrote, once Congress has “prescribed . . . the manner in which the law shall be carried into execution” the President is bound to respect the limitation.²²

2. Preenactment History²³ of the National Security Act of 1947:

The CIA's Predecessor Agencies

Some of the language of the National Security Act, in particular Section 102(d) (5), closely resembles provisions of the Presidential Directive which established the CIA's predecessor agency, the Central Intelligence Group, in 1946. The CIG in turn grew out of the wartime experience with the Office of Strategic Services and its predecessor, the Office of Coordinator of Information.

The evolution from the Office of the Coordinator of Information to the Central Intelligence Agency may indicate what the Executive intended to accomplish through submission of the Central Intelligence Agency section of the National Security Act of 1947. To the extent to which Congress was familiar with this evolution, and with the roles played by the Coordinator of Information, the OSS, and the CIG, it could be said that Congress understood the meaning of the legislation which the Executive proposed and shared in the Executive's expectation of what the legislation would accomplish.

The Office of the Coordinator of Information was established by a Presidential Directive of July 11, 1941. The Directive was preceded by a memorandum to the President by William J. Donovan on June 10, 1941, proposing a centralized intelligence organization with psychological warfare among its functions.²⁴ The Directive did not

²¹ See Senate Select Committee, “Alleged Assassination Attempts Against Foreign Leaders.”

²² *Little v. Barreme*, 2 Cranch 170, 178 (1805). If it is Presidential power which is delegated, then the procedures established for the delegation cannot be disregarded.

²³ Preenactment history is the term given to events occurring prior to the introduction of legislation. Sutherland, *Statutory Construction*, § 48.03 (4th ed. 1973). It encompasses events to which the legislation in question was apparently a response.

Preenactment history is considered by the courts, in some cases, to be significant in determining legislative intent. The challenge is to determine the mischief which particular legislation is meant to remedy. Generally, the courts look to events or patterns of abuse which were well publicized and which Congressmen would most likely know about and have in mind when they enacted a particular law. See e.g. *Clark v. Hebersee Plantz-Korp.*, 322 U.S. 450 (1947).

Thus the relationship between poor coordination of intelligence and the successful bombing of Pearl Harbor by the Japanese could be considered as extrinsic evidence of Congressional intent in passing the National Security Act of 1947.

²⁴ Memorandum from William J. Donovan to the President, 6/10/41. Physical subversion and guerrilla warfare were not mentioned in Donovan's memorandum, but they were discussed with Cabinet officers involved and were felt by Donovan to be implicit with his plan.

mention psychological warfare, but authorized the Coordinator of Information to "collect and analyze all information and data which may bear upon national security" and to "carry out when requested by the President such supplementary activities as may facilitate securing of information important for national security." Like the National Security Act of 1947, the 1941 Directive was designed for flexibility.

The Presidential Directive establishing the COI made no distinction between overt and clandestine collection. Within the month, the COI established a unit to collect intelligence from overt sources, and by October the COI had begun the collection of information by undercover agents outside the Western Hemisphere.²⁵ On October 10, 1941, the "Special Activities" unit was established in COI to take charge of sabotage, subversion, and guerrilla warfare. Thus a Directive which authorized the collection and analysis of information, together with supplementary activities "to facilitate securing of information important for national security" was interpreted within the executive branch as authorizing what is now known as covert action.

All of these events preceded the outbreak of World War II. Following the outbreak of hostilities, President Roosevelt established the Office of Strategic Services (OSS) by military order dated June 13, 1942. Among the functions assigned to the OSS was to "collect and analyze such strategic information as may be required by the United States Joint Chiefs of Staff" and to perform "such special services as may be directed by the Joint Chiefs of Staff." Pursuant to this order, the OSS undertook both clandestine collection of intelligence and covert action.²⁷ The assignment of both these functions to the OSS was opposed by various branches of the Armed Services.

In 1944, William Donovan, then head of OSS, wrote to the President proposing a permanent peacetime intelligence service. He suggested that the service should collect, analyze, and disseminate "intelligence on the policy or strategy level," and that it should be responsible for "secret activities," such as "clandestine subversive operations."²⁸ At roughly the same time that General Donovan made his recommendations, General Doolittle proposed an intelligence agency which would collect intelligence either directly or through existing agencies and perform subversive operations abroad. The Joint Chiefs of Staff and the Department of State eventually responded to the Donovan proposal.³⁰ The debate focused on the extent of the new agency's independence, to whom it should report, and its responsibility for clandestine collection of intelligence.

In September 1945, OSS was disbanded amid the struggle over the future shape of American intelligence activities. By an Executive Order dated September 20, 1945, the responsibility for the clandestine

²⁵ The FBI was responsible for information collected by overt and covert means in the Western Hemisphere.

²⁷ See generally R. Harris Smith, *OSS* (Berkeley: University of California Press, 1972).

²⁸ Memorandum from William Donovan to the President, October 1944, as cited in CIA Legislative History, pp. 12-13.

³⁰ CIA Legislative History, pp. 14-17.

collection of intelligence was transferred to the War Department, where the Strategic Services Unit (SSU) was established.³¹

Also transferred to SSU were the OSS sections responsible for covert psychological and paramilitary activities. In a significant break with wartime operations, however, these latter sections were to be liquidated, leaving only such assets as were necessary for peacetime intelligence.³²

In the absence of agreement among his advisers, President Truman directed Admiral Sidney Souers to prepare a plan for the establishment of a central intelligence organization. On January 22, 1946, President Truman issued a Presidential Directive³³ which established the National Intelligence Authority under the direction of the Director of Central Intelligence. The NIA was to include the Secretary of State, the Secretary of War, the Secretary of the Navy, and the personal representative of the President. Under the Directive, the NIA was to be "assisted by" the Central Intelligence Group, a coordinating body which drew funds and personnel from other agencies of the executive. The CIG was to collect, evaluate, and disseminate intelligence relating to the national security, plan for the coordination of intelligence agencies, and perform "such services of common concern" as the National Intelligence Authority determines can be more efficiently accomplished centrally.³⁴ The CIG was also to perform "such other functions and duties related to intelligence affecting the national security as the President and the National Intelligence Authority may from time to time direct."³⁵

Although the House Select Intelligence Committee was told in 1975 that the CIG was assigned the "function of conducting covert action"³⁶ the former General Counsel of the CIA noted that at the time of the CIG draft directive "there was really . . . no contemplation whatsoever of a program of what might be called covert action."³⁷ In fact, the CIG does not appear to have been engaged in any covert action abroad.³⁷ The covert action capability of the government which had been lodged in OSS and then transferred to SSU in the War Department had been, in early 1946, almost totally liquidated.³⁸ The absence of a covert action program and the decline of the capability

³¹ For the following nine months, until the clandestine intelligence function was transferred to the Central Intelligence Group, SSU was responsible for clandestine intelligence gathering.

³² Testimony of Lawrence Houston, former CIA General Counsel, 6/17/75, p. 6.

³³ Presidential Directive, 1/26/46; 11 *Fed Reg.* 1337, 2/5/46.

³⁴ The Presidential Directive made no explicit mention of clandestine collection of intelligence. It has been suggested that this function was omitted solely to avoid mention of intelligence collection in a published document. (See CIA's Legislative History, 7/25/67, p. 19.)

On July 8, 1946, the NIA issued NIA-5 authorizing the CIG to conduct clandestine intelligence collection outside the United States under the authority of the CIG to perform "services of common concern." NIA-5 resulted in the transfer of SSU to the CIG and the establishment within the CIG of the Office of Special Operations (OSO) to conduct espionage abroad.

³⁵ Rogovin, HSIK Hearings, 12/9/75, p. 1733.

³⁶ Houston, 6/17/75, p. 7.

³⁷ See interviews with Arthur Macy Cox and Lawrence Houston on file at the Center for National Security Studies.

³⁸ Houston, 6/17/75, p. 8.

suggests that a covert action mission for the CIA was not clearly anticipated by either the executive or the Congress.

3. *The Enactment of the National Security Act of 1947*

Efforts to draft legislation for a central intelligence organization began almost immediately after the Presidential Directive of January 22, 1946. Statutory authorization was required by the Independent Offices Appropriation Act of 1944, which provided that no office could receive funding for more than one year without specific authorization and appropriation by Congress. A June 7, 1946 report to the NIA by Admiral Souers, who drafted the 1946 Presidential Directive and who was the first Director of Central Intelligence, indicated the CIG's need for its own budget and personnel as well as for the authority to make certain kinds of contracts.

Lawrence Houston and John Warner,³⁹ both then with the CIG, began to work on a draft which would have established an organization far removed from the coordinating group concept of the CIG. The draft included provisions for an independent budget, direct hiring of personnel, and other administrative authorities which would allow the new agency to be autonomous and flexible. The provisions were drawn up after Houston and Warner had analysed the problems encountered by the OSS during the war, and were designed to avoid these difficulties.⁴⁰ As Houston noted, there was "no specific [covert action] program" under consideration at that time⁴¹ but the aim of the draft was to "provide the Agency with the maximum flexibility for whatever it would be asked to do."⁴²

In January 1947, another drafting group consisting of Clark Clifford, Charles Murphy, Vice Admiral Forest Sherman, and Major General Lauris Norstad, began to consider proposals for an agency to supercede the CIG, this time in the context of a proposal which would unify the Armed Services. On February 26, 1947, President Truman submitted to the Congress a draft entitled, "The National Security Act of 1947." Title 2 of Section 202 provided for a Central Intelligence Agency (CIA), which would report to a National Security Council (NSC). The NSC was to take over the duties of the NIA while the CIA was to have the functions, personnel, property, and records of the CIG.

The section in the draft legislation dealing with the CIA did not spell out, in any detail, its relationship to the rest of the executive branch or its functional responsibilities. As the framers were primarily concerned with the unification of the armed services,⁴³ the draft legislation, according to a memorandum from General Vandenberg to Clark Clifford, eliminated "any and all controversial material insofar as it referred to central intelligence which might in any way

³⁹ Both individuals later served as General Counsel to the CIA. Mr. Houston occupied that post from 1947 until 1974, and Mr. Warner has occupied it since.

⁴⁰ Houston, 6/17/75, p. 9.

⁴¹ *Ibid.*, p. 10.

⁴² *Ibid.*

⁴³ CIA's Legislative History, p. 25.

hamper the successful passage of the Act."⁴⁴ The legislation incorporated by reference the functions of the CIG as set out in the Presidential Directive of January 22, 1946.⁴⁵

S. 758, the Senate version of the draft legislation was referred to the Armed Services Committee, while H.R. 4214 was referred to the House Committee on Expenditures in the Executive Department. The Senate Committee held hearings for ten weeks, went into executive session on May 20, 1947, and reported out an amended version which was approved by voice vote. The House Committee held hearings from early April until July 1. On July 19, the House approved the amended bill and upon receipt of S. 758, amended it in accordance with the language of H.R. 4214. S. 758 emerged from Conference Committee with the functions of the CIA spelled out rather than incorporated by reference; the bill was approved by the Senate on July 24, 1947, and by the House on July 25, 1947.

There is little in the public record of this process to indicate congressional intent with respect to the CIA's authority to engage in covert action. The records of public hearings and floor debates on the National Security Act, as well as the proceedings of a committee meeting in executive session, support the view that Congress as a whole did not anticipate that the CIA would engage in such activities.

The record is ambiguous, however, in part because the legislators and witnesses were concerned that United States security might be compromised by too full and frank a discussion of American intelligence needs on the floor of Congress. As Representative Manasco stated:

Many witnesses appeared before our Committee. They were sworn to secrecy. I hesitate to even discuss this section, as I am afraid that I might say something because the *Congressional Record* is a public record, divulge something here that we received in that Committee that would give aid and comfort to any potential enemy we have.⁴⁶

Related to this point is the possibility that ambiguous language was expressly chosen in order not to offend world opinion. The former General Counsel of the CIA recalled that some Members of Congress sought to put in the statutory language the authorization to conduct espionage and counterespionage. But this we defeated, in "light

⁴⁴ Memorandum from General Vandenberg to Clark Clifford, cited in CIA's Legislative History, p. 27.

Administrative provisions for the CIA were omitted from the proposed legislation in order that unification of the armed services would not be stalled and because there was some concern that the drafting of these could not be completed in time. (*Ibid.*, pp. 26, 32.)

According to the CIA's Legislative History, "There was a general feeling that any unnecessary enlargement of the CIA provision would lead to controversy" and would affect the legislative processing of the National Security Act of 1947. (*Ibid.*, p. 32.)

⁴⁵ These functions had been expanded by NIA-5 to include the clandestine collection of intelligence.

⁴⁶ 93 Cong. Rec. 9605 (1947).

of the argument that they didn't want it advertised that this country was going to engage in such activities."⁴⁷

An additional problem in interpreting the available evidence is that in 1947 no term was clearly understood to mean covert action as the term is used today. Members of Congress and witnesses used terms such as "operational activities," "special operations," or and "direct activities," but these remarks were as likely to have meant clandestine collection of intelligence as covert action. The following exchange between Representative Busbey and Secretary Forrestal in public hearings before the House Committee on Expenditures in the Executive Departments illustrates this problem:

Mr. BUSBEY. Mr. Secretary, this Central Intelligence Group, as I understand it under the bill, is merely for the purpose of gathering, disseminating, and evaluating information to the National Security Council, is that correct?

Secretary FORRESTAL. That is a general statement of their activity.

Mr. BUSBEY. I wonder if there is any foundation in the rumors that have come to me to the effect that through the Central Intelligence Agency, they are contemplating *operational activities*?

Secretary FORRESTAL. I would not be able to go into the details of their operations, Mr. Busbey. The major part of what they do, their major function, as you say, is the collection and collation and evaluation of information from Army Intelligence, Navy Intelligence, the Treasury, Department of Commerce, and most other intelligence, really. Most intelligence work is not of a mystical or mysterious character; it is simply the intelligence gathering of available data throughout this Government. . . . As to the nature and extent of any *direct operational activities*, I think I should rather have General Vandenberg respond to that question.⁴⁸ [Emphasis added.]

Another example is contained in a letter, printed in the hearing record, from Allen Dulles, then a private citizen but later Director of Central Intelligence, to the Senate Armed Services Committee. Dulles recommended that the CIA have its own appropriations, but be able to supplement these with funds from other agencies, "in order to carry on *special operations* which may, from time to time, be deemed necessary by the President, the Secretary of State, and the Secretary of National Defense." [Emphasis added.]⁴⁹

⁴⁷ Houston, 6/17/75, p. 17. See also, memorandum from the CIA General Counsel to the Director, 5/7/48. In 1974, an individual in the CIA's Office of General Counsel wrote that additional statutory authority for covert action was "unnecessary and in view of the delicate nature of the activities, undesirable." (Memorandum from Stephen Hale to the General Counsel, 2/6/74.)

⁴⁸ James Forrestal testimony, House Expenditures in the Executive Departments Committee Hearings on H.R. 2319, 1947, p. 120. There is no record of any later statement by General Vandenberg on the subject.

⁴⁹ Letter from Allen Dulles to the Senate Armed Services Committee, Senate Armed Services Committee, Hearings on S. 758, 1947, p. 521.

Finally, Representative Patterson stated during the floor debates that while he clearly wanted "an independent intelligence agency working without direction by our armed services, with full authority in operation procedures," he knew that it was "impossible to incorporate such broad authority in the bill now before us. . . ." ⁵⁰

These exhaust the statements in open session—in hearings or on the floor—which arguably deal with covert action—although as was previously noted, they may also be read to refer to clandestine intelligence gathering. There is no clear explanation of or proposal for covert action. No justification for covert action was presented by the Executive. ⁵¹ It would be difficult, based upon these statements, to argue that Congress intended to authorize covert action by the CIA.

The legislating committees met extensively in executive session to consider the bill and to discuss the Central Intelligence Agency portions of it. The Select Committee has been able to locate a transcript for only one of these sessions, a June 27, 1947 meeting of the House Committee on Expenditures in the Executive Departments. At that meeting the wisdom of centralizing the clandestine intelligence collection function in the CIA was discussed in some detail. Although the Members and witnesses could put aside the security constraints which might have inhibited them in open session, this record too is ambiguous. It does, however, tend to support the proposition that Congress did not intend to authorize covert action by the CIA.

The CIA has cited two exchanges at this executive session for the proposition that the House Committee on Expenditures "had full knowledge of the broad implications" of the Presidential Directive and understood it to authorize the CIA to engage in covert action. Therefore, according to the CIA, by adapting the National Security Act, which contained the same broad language as the Directive, Congress was authorizing the CIA to conduct covert action. ⁵²

The first exchange quoted was between Representative Clarence Brown and General Hoyt S. Vanderberg, Director of Central Intelligence. The full context of the remarks which the Agency quoted, however, clearly indicates that the broad language of the 1946 Directive had been read to authorize clandestine collection of intelligence. ⁵³

⁵⁰ 83 Cong. Rec., H9447 (1947).

⁵¹ "In none of the formal . . . explanations or justifications did we, so far as I can recall, set forth any program for covert action." (Houston, 6/17/75, p. 10.)

⁵² Rogovin, HSIC, 12/9/75, p. 1734-35.

⁵³ The exchange quoted by the CIA's Special Counsel is italicized in the following quote:

"General VANDENBERG. In 'd' of the President's letter (the Presidential Directive of January 22, 1946), which you read, is the following:

'Perform such other functions and duties related to intelligence affecting the national security as the President and the National Intelligence Authority may from time to time direct.'

That was the basis. The Intelligence Advisory Board, which consists of the Chief of the three departmental intelligence organizations, State, War and Navy, in consultation with the Director of Central Intelligence, made an exhaustive study of the best way to centralize, both from the point of view of efficiency of operations and cost, certain phases of the national intelligence.

Continued

The CIA also cited the executive session testimony of Peter Vischer, who opposed the "other functions and duties" clause. He urged its defeat, calling it a loophole "because it enabled the President to direct the CIG to perform almost any operations."⁵⁴ The CIA notes this opposition, implies that Vischer opposed the clause as it authorized covert action, and claims congressional authorization for covert action because the clause was included in the National Security Act.⁵⁵ The full record shows, however, that Vischer spoke specifically in opposition to centralizing clandestine collection in the CIA. He objected to the "other functions and duties" language as it would authorize such collection.⁵⁶ His objection might have alerted the Committee to "broad implications" in the language, but not to its potential as authorization for covert action.

The only clear reference to the activities which are now referred to as covert action took place in the executive session during an exchange between Representative Rich and General Vandenberg. Representative Rich asked, "Is this agency [the CIG] used in anyway as a propaganda agency?" General Vandenberg responded, "No, sir."⁵⁷

Continued

"They all felt, together with myself, who was Director at that time, that a very small portion, but a very important portion, of the collection of intelligence should be centralized in one place. Now, the discussion went on within the Intelligence Advisory Board as to where that place should be.

Mr. BROWN. May I interrupt just a moment there? In other words, you proceeded under the theory that this Central Intelligence Agency was authorized to collect this information and not simply to evaluate it?

General VANDENBERG. We went under the assumption that we should inform the National Intelligence Authority, with the setting up of the Central Intelligence Group, on an efficient basis, as was required from us from time to time to advise, because we were the Advisory Board for the National Intelligence Authority; and that part that says that we should "perform such other functions and duties as the President and the National Intelligence Authority may from time to time direct" and "recommend to the National Intelligence Authority the establishment of such overall policies and objectives as will assure the most effective accomplishment of the National Intelligence mission" gave us that right.

Mr. BROWN. Then, you did not consider that the word "evaluate" was a limitation on your duty, but *this other section was so broad that you could do about anything that you decided was either advantageous or beneficial, in your mind?*

General VANDENBERG. Yes, sir.

Mr. BROWN. *In other words, if you decided you wanted to go into direct activities of any nature, almost, why, that would be done?*

General VANDENBERG. *Within the Foreign Intelligence field, if it was agreed upon by all the three agencies concerned.*

Mr. BROWN. And that you were not limited to evaluation?

General VANDENBERG. That is right, sir.

(Transcript, House Committee on Expenditures in the Executive Department, Hearings on H.R. 2310, 0/27/47, pp. 9-11.)

Walter Pforzheimer has told one interviewer that General Vandenberg testified in the executive session about intelligence collection because Army Intelligence opposed any intelligence gathering by the CIA. Covert action, according to Pforzheimer, was not mentioned. Interview on file at the Center for National Security Studies.

In addition, as was noted earlier, there is no evidence that the Central Intelligence Group did engage in covert action.

⁵⁴ Rogovin, HSIC, 12/0/75, p. 1735.

⁵⁵ *Ibid.*

⁵⁶ Transcript, House Committee on Expenditures in the Executive Departments, Hearings on H.R. 2310, 0/27/47, p. 37.

⁵⁷ *Ibid.*, p. 37.

These statements and the discussions in the executive session about the CIA's role in clandestine intelligence gathering suggest that the ambiguous references in the public hearings referred to clandestine collection operations.

Because the Select Committee has been unable to locate transcripts of the other executive sessions, it is impossible to state conclusively that covert action was not explicitly mentioned during these meetings. However, none of the participants queried recalled any such discussions and none of the committee reports contain any references to covert action.

A memorandum by the CIA's General Counsel, written soon after the passage of the Act, noted that "We do not believe that there was any thought in the minds of Congress that the Central Intelligence Agency, under this authority, would take positive action for subversion and sabotage." In that September 25, 1947 memorandum to the Director, the General Counsel wrote:

A review of debates indicates that Congress was primarily interested in an agency for coordinating intelligence and originally did not propose any overseas collection activities for CIA. The strong move to provide specifically for such collection overseas was defeated, and, as a compromise, Sections 102(d) (4) and (5) were enacted, which permitted the National Security Council to determine the extent of the collection work to be performed by CIA. We do not believe that there was any thought in the minds of Congress that the Central Intelligence Agency under this authority would take positive action for subversion and sabotage. A bitter debate at about the same time on the State Department's foreign broadcast service tends to confirm our opinion. Further confirmation is found in the brief and off-the-record hearings on appropriations for CIA. . . . It is our conclusion, therefore, that neither M.O. [morale operations] nor S.O. [special operations] should be undertaken by CIA without previously informing Congress and obtaining its approval of the functions and the expenditure of funds for those purposes.⁶⁸

All of this is not to suggest that Congress or any Members of Congress specifically intended that covert action should be excluded from the authorized missions of the CIA. The issue of covert action simply was not raised in the course of the legislation's enactment. As the CIA's former General Counsel told the Senate Select Committee, there is "no specific legislative history supporting covert action as part of the functions assigned" to the CIA.⁶⁹ Rather than authorizing covert action, the broad language of 102(d) (5) appears to have

⁶⁸ Memorandum from the CIA General Counsel to the Director. 8/25/47.

This memo may have been the result of an inquiry by Admiral Hillenkoetter, who had been asked by Secretary Forrestal if the CIA would be able to conduct covert and cold war activities such as black propaganda and sabotage in support of guerrilla warfare. Admiral Hillenkoetter, who had doubts about the CIA's authority to undertake such activities, asked his General Counsel for his opinion. (Houston, 6/17/74, p. 18-15.)

⁶⁹ Houston, 6/17/76, p. 10.

been intended to authorize clandestine collection of intelligence⁶⁰ and to provide the CIA with the "maximum flexibility"⁶¹ necessary to deal with problems which, due to America's inexperience with a peacetime intelligence agency, might not be foreseen.

D. Post Enactment History

As previously noted, the executive branch presented no justification to the Congress for the conduct of covert action by the CIA. Yet even while the National Security Act of 1947 was being drafted, introduced, debated, and passed the Coordinating Committee of the Departments of State, War, and the Navy (SWNCC) prepared a paper establishing procedures for psychological warfare during peacetime as well as wartime. On April 30, 1947, SWNCC established a Subcommittee on Psychological Warfare to plan and execute psychological war.

These plans took on new importance as the United States became concerned over the course of events in Western Europe and the Near East. Tension soon became so high that in December of 1947, the Department of State advised the NSC that covert operations mounted by the Soviet Union and her allies threatened the defeat of American foreign policy objectives. The Department recommended that the U.S. supplement its own foreign policy activity with covert action.

At its first meeting in December, 1947, the National Security Council approved NSC-4, which empowered the Secretary of State to coordinate information activities designed to counter communism. A top secret annex took cognizance of the "vicious psychological efforts of the USSR, its satellite countries, and Communist groups to discredit and defeat the activities of the U.S. and other Western powers." The NSC determined that "in the interests of world peace and U.S. national security the foreign information activities of the U.S. government must be supplemented by covert psychological operations."

The CIA was already engaged in clandestine collection of intelligence and, as the NSC put it, "The similarity of operational methods involved in covert psychological and intelligence activities and the need to ensure their secrecy and obviate costly duplication renders the CIA the logical agency to conduct such operations." Therefore, acting under the authority of section 102(d)(5) of the National Security Act of 1947, the NSC instructed the Director of Central Intelligence to initiate and conduct covert psychological operations that would counteract Soviet and Soviet-inspired covert actions and which would be consistent with U.S. foreign policy and overt foreign information activities.⁶²

In the following months the CIA was involved in a number of covert actions. As the Soviet threat loomed larger and larger, the need for covert action, beyond psychological operations, seemed more pressing. On June 18, 1948, the NSC issued NSC-10/2 which superseded NSC-4-A, and vastly expanded the range of covert activities. The CIA was

⁶⁰ Memorandum from the CIA General Counsel to the Director, 5/7/48.

⁶¹ Houston, 6/17/75, p. 10.

⁶² Pursuant to the NSC's instruction, the Special Procedures Group was established in the Office of Special Operations (OSO) of the CIA to conduct covert psychological operations.

authorized to undertake economic warfare, sabotage, subversion against hostile states (including assistance to guerrilla and refugee liberation groups), and support of indigenous anti-communist elements in threatened countries.

The NSC noted that CIA was already charged with espionage and counterespionage abroad.⁶³ Because of this, according to the NSC, it was "desirable" for "operational reasons" to assign covert action authority to the CIA rather than to create a new unit. Therefore, under the authority of 50 U.S.C 403 (d) (5), the NSC ordered the establishment in CIA of the Office of Special Projects (OSP), to conduct covert action. The Chief of OSP was to receive policy guidance from the Secretary of State and the Secretary of Defense. OSP (later, OPC) was to operate independently of all components of the CIA to the maximum degree consistent with efficiency.⁶⁴

Thus even though the CIA's General Counsel could find no authority in the legislative history of the National Security Act, the NSC relied upon the Act to direct the CIA to initiate covert action. Language intended to authorize clandestine intelligence gathering and to provide flexibility for unforeseen circumstances was broadened by the executive to cover sabotage, subversion and paramilitary activities. The executive branch did not heed the advice offered by the CIA's General Counsel in 1947 that congressional authorization was still "necessary."⁶⁵ This may well have been due to a belief in the power of the President to direct such activities.⁶⁶

It is impossible to prove conclusively that Congress intended or did not intend to authorize covert action by the CIA through the passage of the National Security Act of 1947. It is possible, however, after reviewing the hearings, committee reports, and floor debates, to say that there is no substantial evidence supporting the existence of Congressional intent to authorize covert action by the CIA through the enactment of the National Security Act.

This conclusion is supported by the following:

- (1) The absence of any explicit provision in the Act itself.
- (2) The absence of any reference to covert action in the committee reports.
- (3) The absence of any clear statement by a Member of Congress, in the hearings or debates, which demonstrates the intent to authorize covert action.
- (4) The absence of any reference to a program of covert action in the justifications and explanations by the executive branch of the Act.

⁶³ The CIA had also been charged with conducting covert psychological operations under the authority of NSC 4-A.

⁶⁴ Both NSC 4-A and NSC 10/2 cited 50 U.S.C. (d) (5); neither invoked the President's authority, if any, to order covert action in the absence of congressional authorization.

⁶⁵ Memorandum from the CIA General Counsel to the Director, 9/25/47, p. 2.

⁶⁶ The General Counsel of the CIA noted his belief that "if [the CIA got] the proper directive from the executive branch and the funds from the Congress to carry out that directive, these two together are the true authorization." (Memorandum from the General Counsel of the CIA to the Director, 10/30/60, at p. 2.)

(5) The absence of any discussion in the hearings or debates of the threats which would suggest the need for a covert action capability.

(6) The conclusion of the CIA's General Counsel, immediately following the Act's passage, that the CIA lacked statutory authority for covert action and that sections (d) (4) and (5) were intended by Congress to authorize clandestine intelligence gathering by the CIA.

B. THE CIA ACT OF 1949

Passage of the CIA Act of 1949 has also been cited as support for the view that Congress has authorized covert action by the CIA. A careful analysis of the Act's legislative history does not support this view.

Two years after the enactment of the National Security Act and after the NSC had directed the CIA to engage in various covert activities, Congress passed the Central Intelligence Agency Act of 1949.⁶⁸ The 1949 legislation was an enabling act containing administrative provisions necessary for the conduct of the Agency's mission.⁶⁹ As such, it did not add to the missions of the Agency. The events surrounding its passage, however, may shed light upon what Congress believed it had authorized in the National Security Act of 1947.

The Act included a number of administrative provisions which clearly were designed to assure the security of some sort of clandestine activity by the CIA. These included the waiver of normal restrictions placed on governmental acquisition of materiel, hiring and, perhaps more important, accounting for funds expended. The General Counsel of the Central Intelligence Agency wrote that:

Provision of unvouchered funds and the inviolability of such funds from outside inspection is the heart and soul of covert operation.⁷⁰

The Central Intelligence Agency has argued that passage of the Central Intelligence Agency Act of 1949 "clearly reflects Congress' determination that the Agency be able to conduct activities such as covert action, similar to those conducted by the OSS."⁷¹ Although members of the House Armed Services Committees were aware that the Central Intelligence Agency was conducting covert operations and that the administrative provisions would be "essential to the flexibility

⁶⁸ 50 U.S.C. 408a-408j.

⁶⁹ The administrative provisions had been included in a draft of the National Security Act of 1947 shown to Members of the House of Representatives. In order to avoid having to detail administrative provisions for all of the organizations set up under the National Security Act, these provisions were removed from the draft to be presented later as a separate act.

⁷⁰ Memorandum from the CIA General Counsel to the Director, 5/25/49, p. 2.

⁷¹ Rogovin. HSC, 12/0/75, p. 1736.

and security"⁷² of these operations, there is no evidence that Congress as a whole knew the range of clandestine activities, including covert action, which was being undertaken by the CIA. The committee reports on the Central Intelligence Agency Act include no reference to covert action. The floor debates contain only one reference to covert action, and strongly suggest that the Congress knew only that clandestine intelligence gathering was going on.

In addition, the provisions of the 1949 Act are not uniquely designed to facilitate covert action. They would serve the needs of an organization performing espionage equally well; Members of Congress, in fact, described the Act as an "espionage bill."⁷³ Thus even a careful reader of the Act would not infer from its provisions that the Agency was conducting covert action.

Given these facts, it is difficult to find in the Act's passage congressional intent to authorize covert action or a congressional belief that the National Security Act of 1947 had authorized it.

The bill which was to become the Central Intelligence Agency Act of 1949 was first introduced in Congress in 1948. The Director of Central Intelligence appeared before the House Armed Services Committee on April 8, 1948, to discuss the bill. The Director noted:

It was thought when we started back in 1946, that at least we would have time to develop this mature service over a period of years—after all, the British, who possess the finest intelligence in the world, have been developing their system since the time of Queen Elizabeth. Unfortunately, the international situation has not allowed us the breathing space we might have liked, and so, as we present this bill, we find our-

⁷² The CIA General Counsel described the provisions of the Central Intelligence Agency Act of 1949 as follows:

"Administrative authorities of the Agency are contained in the Central Intelligence Agency Act of 1949, as amended. This has provided us with all the authorities and exemptions needed to carry out the wide variety of functions assigned to the Agency during the past twenty years. It enables us to have an effective and a flexible personnel program, ranging from the normal desk officer in headquarters to persons in a relationship so remote that they do not know they are working for the Agency. It enables us to exercise all the techniques required for clandestine activities, from traditional agent operations through proprietary and other more sophisticated types of machinery. It has enabled us to undertake major unforeseen projects, such as the U-2 operation.

"Two provisions of the Act are particularly important. The unique authority in Section 5 to transfer to and receive from other government agencies sums as may be approved by the Bureau of the Budget. This has given us great flexibility and security in our funding. The other, Section 8, with its wide authority for utilization of sums made available to the Agency, particularly subsection (b) thereof which allows us to make any expenditures required for confidential, extraordinary, or emergency purposes, and these expenditures will be accounted for solely on the certificate of the Director. This has been essential to the flexibility and security of our covert activities." (Memorandum from the CIA General Counsel to the Deputy Director for National Intelligence Programs Evaluation 10/9/68, p. 3.)

⁷³ 95 Cong Rec. 1046 (1949).

selves in operations up to our necks, and we need the authorities contained herein as a matter of urgency.⁷⁴

It is clear that the operations that the Director referred to were understood by the executive branch to include covert action. In describing the provision of the bill which would eliminate the normal government advertising requirements, the Director stated that there were urgent requests from overseas which required immediate operational response. As an example, he provided: "Any possible action in connection with the Italian election."⁷⁵ In later remarks on the same section,⁷⁶ the Director cited the need to avoid advertising for contracts for the production of certain matériel, listing among his examples explosives and silencers.⁷⁷ Such matériel was clearly not for the purposes of clandestine intelligence gathering and reporting.

In his 100-page statement, the Director also explained the provision for unvouchered funds, the provision which the General Counsel of the Central Intelligence Agency described as the "heart and soul of covert operations." The Director stated:

In view of the nature of the work which must be conducted by the CIA under the National Security Act and applicable directives of the National Security Council, it is necessary to use funds for various covert or semi-covert operations and other purposes where it is either impossible to conform with existing government procedures and regulations or conformance therewith would materially injure the national security. It is not practicable, and in some cases impossible, from either a record or security viewpoint to maintain the information and data which would be required under usual government procedures and regulations. In many instances, it is necessary to make specific payments or reimbursements on a project basis where the background information is of such a sensitive nature from a security viewpoint that only a general certificate, signed by the Director of CIA, should be processed through even restricted channels. To do otherwise would obviously increase the possibilities of penetration with respect to any specific activity or general project. The nature of the activities of CIA are such that items of this nature are recurring and, while in some instances the confidential or secret aspects as such may not be of primary importance, the extraordinary situations or the exigencies of the particular transaction involved warrant the avoidance of all normal channels and procedures.⁷⁸

On the basis of this presentation, it can be concluded that at least the House Armed Services Committee, one of the committees which had jurisdiction over the CIA, knew that the CIA was conducting or would in the future conduct covert action. The Committee also knew that

⁷⁴ Statement of Adm. Roscoe Hillenkoetter, Director of Central Intelligence, House Armed Services Committee, 4/8/48, pp. 6-7 (statement on file at the CIA).

⁷⁵ *Ibid.*, p. 21.

⁷⁶ Sect. 3 (a) of H.R. 5871, 80th Cong., 2d Session.

⁷⁷ Hillenkoetter, 4/8/48, p. 27. These examples were drawn by the Director from the history of the OSS.

⁷⁸ *Ibid.* pp. 111-118.

the administrative provisions would enhance the Agency's covert action capability.⁷⁹

The evidence, however, is not entirely clear. While the present day reader may interpret "covert or semicovert operations" to mean covert action, the Members had had little exposure to these terms. Covert or semicovert operations could easily have been interpreted to mean clandestine intelligence gathering operations; the CIA's role in clandestine intelligence gathering had been discussed in a hearing before the same committee,⁸⁰ as well as in the press.⁸¹

Even if it were assumed, moreover, that the House and Senate Armed Services Committees fully understood that the CIA was engaging in covert action, there is no evidence that the Congress as a whole knew that the CIA was engaged in covert action or that the administrative provisions were intended to facilitate it. The hearings on the CIA Act of 1949 were held almost entirely in executive session. The committee reports on the Act did not mention covert action at all. They were bland and uninformative—the provision to provide the secret funding of the CIA through transfers from appropriations to other government agencies was described as providing "for the annual financing of Agency operations without impairing security."⁸² They were strikingly incomplete. As the House Armed Services Committee report itself noted, the report:

does not contain a full and detailed explanation of all of the provisions of the proposed legislation in view of the fact that much of such information is of a highly confidential nature.⁸³

The floor debates contain only one indication that covert action, as opposed to clandestine intelligence gathering, was being, or would be undertaken by the CIA.⁸⁴ The debates strongly suggest that rather than approving covert action by the CIA, Congress was attempting to facilitate clandestine intelligence gathering by the Agency.

Prior to the passage of the Act there had been discussion in the press of CIA involvement in clandestine intelligence gathering. Clandestine intelligence gathering was mentioned on the floor; as noted previously, Members referred to the CIA Act of 1949 as an "espionage bill."⁸⁵ Senator Tydings, the Chairman of the Senate Armed Services Committee, stated, "The bill does not provide for new activity, but what it does particularly is to seek to safeguard information procured by

⁷⁹ It is quite likely that the Senate Armed Services Committee was presented with a similar statement from the Director, although the Senate Select Committee has been unable to locate any transcripts of executive sessions held by the Senate Armed Services Committee.

⁸⁰ Testimony of Gen. Hoyt S. Vandenberg before House Armed Services Committee Hearing on H.R. 5871, 4/8/48 (statement on file at the CIA).

⁸¹ "The X at Bogatá," *The Washington Post*, 4/13/48; Hanson W. Baldwin, "Intelligence—II," *The New York Times*, 7/22/48.

⁸² S. Rep. No. 725, 81st Cong., 1st Sess. 4 (1949).

⁸³ H. Rep. No. 160, 81st Cong., 1st Sess. 6 (1949). See also 95 Cong. Rec. 1046 (1949), remarks of Rep. Marcantonio.

⁸⁴ It was remarked in the House debates, in the context of a discussion of intelligence gathering that "in spite of all our wealth and power and might we have been extremely weak in psychological warfare, notwithstanding the fact that an idea is perhaps the most powerful weapon on this earth." (95 Cong. Rec. 1047 (1949).)

⁸⁵ 95 Cong. Rec., 1046 (1949).

agents of the government so that it will not fall into the hands of enemy countries or potential enemy countries who would use the information to discover who the agents were and kill them."⁶⁶ Thus there is ample evidence to suggest that the full legislature knew that the functions of the CIA included espionage; but there is no evidence to suggest that more than a few Members of Congress knew that the CIA was engaged in covert action. Without such knowledge Congress could hardly be said to have authorized it.⁶⁷

Another factor undercutting the theory that passage of the CIA Act constituted congressional authorization for covert action is that the argument confuses implementing authority with statutory authority. Congress had set out the CIA's statutory authority in the National Security Act of 1947. The CIA Act of 1949 did not provide any additional non-administrative or non-fiscal powers to the CIA.⁶⁸ It simply provided the means for the CIA to implement the authorities already granted it.

C. THE PROVISION OF FUNDS TO THE CIA BY CONGRESS

There is no evidence that Congress intended, by the passage of the National Security Act of 1947, to authorize covert action by the CIA. Passage of the Central Intelligence Agency Act of 1949 did not add the covert action mission to those already authorized by the National Security Act. Nevertheless, the National Security Council had in 1947 directed the CIA to engage in covert activities; by the early 1950s the Central Intelligence Agency was involved in covert action around the world.

In 1962 the General Counsel summarized the early developments in the CIA's undertaking of covert action:⁶⁹

The National Security Council did develop a Directive (NSC 10/2) setting forth a program of covert cold-war activities and assigned it to the Office of Policy Coordination under the Director of Central Intelligence with policy guidance from the Department of State. The Congress was asked for and did appropriate funds to support this program, although, of course, only a small number of Congressmen in the Ap-

⁶⁶ 95 Cong. Rec. 6955 (1949). This quote, indicating Chairman Tydings' interpretation of the Act, seems to undercut the argument that he and the Senate Armed Services Committee understood that the CIA was conducting covert action and that the provisions of the CIA Act of 1949 were designed to facilitate this.

⁶⁷ Without such knowledge a Member reading the Act would not be likely to infer that it was designed to facilitate covert action. As the provisions of the Act were not uniquely designed for covert action but were equally applicable to clandestine intelligence gathering, an activity which Congress knew about and approved, Members would be unlikely to realize from reading the Act that the CIA conducted covert action.

⁶⁸ S. Rep. No. 100, 81st Cong., 1st Sess. 1 (1949).

⁶⁹ In a September 25, 1947 memorandum to the Director, the General Counsel advised that no covert action "should be undertaken by CIA without previously informing Congress and obtaining its approval of the functions and expenditure of funds for those purposes." He further noted that even if the NSC were to assign the covert action function to the CIA it would still be necessary for the CIA to "go to Congress for authority and funds." (Memorandum from the CIA General Counsel to the Director, 9/25/47).

appropriations Committees knew the amount and purpose of the appropriations.⁹²

The Office of Legislative Counsel of the Department of Justice argued in 1962 that this provision of funds for covert action, even though known only to a few members of Congress, constituted congressional ratification of the CIA's conduct of covert action.

Congress has continued over the years since 1947 to appropriate funds for the conduct of such covert activities. We understand that the existence of such covert activities has been reported on a number of occasions to the leadership of both houses, and to members of the subcommittees of the Armed Services and Appropriations Committees of both houses. It can be said that Congress as a whole knows that money is appropriated to CIA and knows generally that a portion of it goes for clandestine activities, although knowledge of specific activities is restricted to the group specified above and occasional other members of Congress briefed for specific purposes. In effect, therefore, CIA has for many years had general funds approval from the Congress to carry on covert cold-war activities, which the Executive Branch has the authority and responsibility to direct.

It is well-established that appropriations for administrative action of which Congress has been informed amount to a ratification of or acquiescence in such action. *Brooks v. Dewar*, 313 U.S. 354, 361; *Fleming v. Mohawk Co.*, 331 U.S. 111, 116; see also *Ivanhoe Irrig. Dist. v. McCracken*, 357 U.S. 275, 293-294; *Power Reactor Co. v. Electricians*, 367 U.S. 396, 409. Since the circumstances effectively prevent the Congress from making an express and detailed appropriation for the activities of the CIA, the general knowledge of the Congress, and specific knowledge of responsible committee members, outlined above, are sufficient to render this principle applicable. [Citations omitted.]⁹³

And in December 1975 the House Select Committee on Intelligence was told by the CIA that given "CIA reporting of its covert action programs to Congress, and congressional appropriation of funds for such programs" the "law is clear that, under these circumstances.

⁹² Memorandum from the CIA General Counsel to the Director, 1/15/62, p. 2.

⁹³ Memorandum re: "Constitutional and Legal Basis for So-called Covert Activities of the Central Intelligence Agency," prepared by the Office of Legislative Counsel, Department of Justice, 1/17/62, pp. 12-13.

The Office of Legislative Counsel apparently placed considerable weight on the knowledge of the subcommittee members of the committees having jurisdiction over the CIA (*Ibid.*, p. 12 n. 4) and implied "close contact" between the CIA and "its committees," (*Ibid.*, p. 13 n. 5) For example, the memorandum cited a letter dated May 2, 1967, from Mr. Allen W. Dulles, Director, CIA, to Sen. Hennings, in *Freedom of Information and Secrecy in Government*, Hearing before the Subcommittee on Constitutional Rights of the Senate Committee of the Judiciary, 85th Cong., 2d Sess., pp. 376, 377:

"The Director of the Central Intelligence Agency appears regularly before established subcommittees of the Armed Services and Appropriations Committees of the Senate and of the House, and makes available to these subcommittees complete information on Agency activities, personnel and expenditures. No information has ever been denied to their subcommittees."

Congress has effectively ratified the authority of the CIA to plan and conduct covert action under the direction of the President and the National Security Council.⁹⁵

In order to analyze the claim that congressional provision of funds to the CIA constitutes congressional ratification of the CIA's authority to conduct covert action, the general question of congressional ratification by appropriation must be examined. The general rule has been stated as follows: "Ratification by appropriation is not favored and will not be accepted where prior knowledge of the specific disputed action cannot be demonstrated clearly."⁹⁶ In the same opinion the Court noted that:

ratification by appropriation, no less than ratification by acquiescence, requires affirmative evidence that Congress actually knew of the administrative policy. . . . Moreover, to constitute ratification, an appropriation must plainly show a purpose to bestow the precise authority which is claimed."
[Citations omitted.]

Appropriations do not convey authority or ratify agency acts without proof that Congress knew what the agency was doing. For instance, in *Green v. McElroy*, 360 U.S. 474, the Supreme Court held that an appropriation to the Department of Defense for its security program did not constitute ratification of a procedure which denied the right of an individual to confront the witnesses against him. On the other hand, if appropriations are enacted after objections have been made to the appropriations committees that no legal authority exists to carry out a particular project, congressional acknowledgment or ratification of the authority to perform the specified act can be inferred.⁹⁷

In sum, general appropriations for an agency cannot be deemed to be ratification of a specific activity of that agency in the absence of congressional knowledge of the specific activity and congressional intent that the specific activity be funded from the general appropriation.⁹⁸

The argument that through the provision of funds to the CIA Congress has effectively ratified the authority of the CIA to conduct covert action rests on the assumption that since the founding of the Agency, Congress has known that CIA was engaged in covert action and has provided funds to the CIA with the knowledge and intent that some of the funds would be used for covert action.

The CIA's conduct of covert action was not known by Congress as a whole during the early years of the CIA. In the interest of security, few Members were informed about covert actions—a situation which

⁹⁵ Rogovin, HSIC, 12/0/75, p. 1736.

⁹⁶ *D.C. Federation of Civic Associations v. Airls*, 301 F.2d 478, 482 (D.C. Cir. 1963).

⁹⁷ *United States ex rel Tennessee Valley Authority v. Two Tracts of Land*, 456 F.2d 264 (6th Cir. 1972). Appropriations for the Vietnam War, in combination with other congressional actions, were held by most courts to constitute congressional authorization for the war. See e.g., *Berk v. Laird*, 317 F. Supp. 715 (E.D. N.Y. 1970). But see, *Mitchell v. Laird*, 488 F. 2d 611 (D.C. Cir. 1973).

⁹⁸ *Thompson v. Clifford*, 408 F.2d 154 (D.C. Cir. 1968); Sutherland, *Statutory Construction* (Sands ed. 1974) sec. 40.10.

continued until Congress mandated disclosure to six congressional committees of CIA activities not intended solely for intelligence gathering.⁹⁹ Even prior to this mandate, many Members of Congress not briefed on covert action by the executive branch probably knew that the CIA had engaged in covert actions such as the Bay of Pigs; this knowledge was not official being based neither on declarations of official U.S. policy nor on briefings of the Congress as a whole, but rather on information gained from other sources.¹⁰⁰ One of the reasons offered for the 1974 Amendment to the Foreign Assistance Act was that it would ensure that Congress would have sufficient information about covert action to determine if such activities should continue.¹⁰¹

It is difficult to fix a point in time in the past when it could be said with assurance that Congress as a whole "clearly" had the knowledge of covert action required for congressional ratification.¹⁰² Congress certainly has that knowledge today.

The first requirement, congressional knowledge of covert action by the CIA, is, at least now, met. In the future appropriation to the CIA without any provision prohibiting the use of funds for covert action would ratify the CIA's authority. But did the provision of funds to the CIA in the past, or will the provision of funds in the future under present arrangements constitute "appropriations" which "plainly show a purpose to bestow the precise authority which is claimed"?

The answer would be a clear yes if the funding had been or were to be by open appropriations to the CIA. The answer would be yes if Congress as a whole had voted the appropriations to the CIA in executive session. This has not been the case.

The funds provided to the CIA are concealed in appropriations made to other agencies. They are then transferred to the CIA, pursuant to the provisions of the CIA Act of 1949,¹⁰³ with the approval of

⁹⁹ 22 U.S.C. 2422.

¹⁰⁰ Under the system of plausible denial the U.S. Government would not officially confirm that it engaged in covert action and would seek to avoid acknowledging a U.S. Government role in any particular covert action. Therefore, the knowledge imputed to Members of Congress not officially briefed on the CIA's covert actions would have to be based on other sources.

¹⁰¹ Cong. Rec., S18005, daily ed., 10/2/74 (remarks of Senators Baker and Symington).

¹⁰² It might be argued that Congress chose to limit knowledge of covert action to selected Members and that *their* knowledge, combined with that congressional decision, would be sufficient. J. Edwin Dietel, of the Office of General Counsel of the CIA, in a 11/20/73 memorandum for the record, in fact wrote: "We would also note that, while the specific activities that the Agency's appropriations are used for is limited to only a few Members of Congress, the whole Congress chose to adopt that procedure for reviewing the Agency's activities and appropriations."

First, it must be noted that until Congress "knew" about covert action, Congress could not delegate to a small group of Members the responsibility for overseeing it. When Congress reached that point of knowledge—and as noted it is impossible to say when that was—it arguably could delegate although there may be limits to that delegation.

Given the presumption against ratification by appropriation, the difficulty in fixing a time when Congress "knew," as well as the small number of knowledgeable Members, and the question of whether Congress could delegate to these Members the congressional knowledge required for ratification, it cannot be concluded that the knowledge of these few Members met the test cited for ratification by appropriation.

¹⁰³ 50 U.S.C. 403 f.

the OMB and selected members of the Appropriations Committee. Congress, as a whole, never specifically votes on funds for the CIA. Congress, as a whole, does not know how much money the CIA will receive in a given year.¹⁰⁴ This secret funding undercuts the argument that the Congress has notified the CIA's conduct of covert action by knowingly appropriating funds to be used for covert action. In fact, there is some doubt that the CIA is even "appropriated" funds pursuant to the constitutional requirement.¹⁰⁵

Even if the provision of funds is constitutionally valid, in the absence of a vote by Congress on the funding, it can hardly be said to "plainly" demonstrate a congressional intent to ratify the CIA's authority to conduct covert action.

The CIA ignored the questionable nature of Congress' knowledge of covert action and the secret funding of the CIA in claiming that "the law is clear that, under these circumstances, Congress has effectively ratified the authority of the CIA to plan and conduct covert action under the direction of the President and the National Security Council."¹⁰⁶ In support of its position, the Central Intelligence Agency cited what was described as "the leading case on this point," *Brooks v. Dewar*, 313 U.S. 354 (1941). According to the Central Intelligence Agency, "the Brooks case requires the conclusion that Congress has ratified the CIA's authority to plan and conduct covert action."¹⁰⁷

Brooks involved a challenge to a licensing scheme established by the Secretary of the Interior under a statute providing him with broad responsibility for the administration of livestock grazing districts. Although the act in question did not explicitly authorize him to require persons wishing to utilize the land to purchase licenses, the Court found congressional ratification of his actions. The Court, in upholding the Secretary's argument that Congress had ratified his action wrote, "The information in the possession of Congress was plentiful and from various sources."¹⁰⁸ The Court cited annual reports of the

¹⁰⁴ For a fuller discussion of the funding of the CIA, see Chap. XVI, p. 307.

¹⁰⁵ Article I, Sec. 9, Clause 7 of the Constitution provides that "No Money shall be drawn from the Treasury but in Consequence of Appropriations made by Law." Appropriations are, by definition, specific amounts of money set aside for designated purposes [*Geddes v. United States*, 39 Ct. Claims, 428, 444 (1908)] It is not required to particularize each item in order for an appropriation to be valid [*United States v. State Bridge Commission*, 109 F. Supp. 690 (E. D. Mich. 1953)] but the appropriation must be sufficiently identifiable to make clear the intent of Congress. [*Ibid.*] As Congress votes on appropriations for other agencies from which CIA funds are secretly transferred rather than setting aside a specific sum of money for the CIA for a specific purpose, it can be argued that there is no constitutionally valid appropriation to the Agency. If the public accounting required by Article 1, Sec. 9, Clause 7 is a necessary condition for a constitutionally valid appropriation, it would be even harder to argue the validity of the present funding scheme as the statement published pursuant to the constitutional requirements do not reflect receipts and expenditures of the CIA.

The argument might be made that congressional establishment of the transfer provisions of the CIA Act of 1949 manifested a congressional purpose to authorize the CIA to conduct covert action. However, nothing in the debates supports this argument. Moreover, the transfer provision was equally applicable to any clandestine activity, including the clandestine collection of intelligence.

¹⁰⁶ Rogovin, H.SIC, Hearings, 12/9/75, p. 1786.

¹⁰⁷ *Ibid.*

¹⁰⁸ 313 U.S. at 360.

Secretary, testimony at Appropriation Committee hearings, and statements on the floor of Congress. The Court found that the "repeated appropriations of the fees thus covered and to be covered into the Treasury . . . constitutes a ratification of the action. . ." ¹⁰⁹

Given the special treatment of the CIA, the relevance of *Brooks* seems questionable. "Plentiful" information is not available. No annual reports are issued by the Director of Central Intelligence. Until recently there have been few open hearings or floor debates on the activities of the CIA. Congress as a whole has never voted on appropriations for the CIA, nor designated funds for covert action.

Brooks and several other cases are also cited by a Justice Department memorandum written in 1962 and presented to the House Select Committee on Intelligence in 1975. The memorandum argues that:

Since the circumstances effectively prevent the Congress from making an express and detailed appropriation for the activities of the CIA, the general knowledge of the Congress, and specific knowledge of responsible committee members . . . are sufficient to render this principal [ratification] applicable. ¹¹⁰

Given the presumption against ratification by appropriation, the small number of knowledgeable Members, the uncertainty as to whether congressional knowledge required for ratification could be imputed from the knowledge of these few Members, and the question of whether a congressional appropriation can be imputed from the approval of secret transfers of funds to the CIA by subcommittees of the House and Senate Appropriations Committees, there is substantial doubt as to the validity of this position.

As was previously noted, the actual state of congressional knowledge about covert action prior to the 1970s is unclear. Congress, however, now knows that the CIA conducts covert action. Congress also knows that the Executive claims Congress has authorized the Agency to do so. ¹¹¹ Finally, Congress knows that the CIA receives its funds through secret transfers of funds appropriated to the Department of Defense ¹¹² and that some of the transferred funds are used to finance cover action. In the future the failure by Congress to prohibit funds from being used for covert action by the CIA would clearly constitute congressional ratification of the CIA's authority, eliminating any ambiguity. ¹¹³

¹⁰⁹ *Ibid.*

¹¹⁰ Rogovin, HSIC, 12/9/75, p. 1730.

¹¹¹ Congressional acquiescence, with notice, of long-standing executive policy, creates a presumption in favor of that policy's validity (*United States v. Midwest Oil Co.*, 236 U.S. 459 (1915)). See also, *Sibaoh v. Wilson & Co.*, 312 U.S. 1 (1941).]

¹¹² Cong. Rec., H9359-70, daily ed., 10/1/75.

¹¹³ Congress clearly has the authority to attach conditions to the use of the funds appropriated by it. [*Ohio v. United States Civil Service Commission*, 65 F. Supp. 776 (S.D. Ohio 1946); *Spalding v. Douglas Aircraft Co.*, 60 F. Supp. 985, 988 (1945) *aff'd* 154 F. 2d 419 (9th Cir. 1946).]

Such ratification, however, like ratification by acquiescence,¹¹⁴ would still be disfavored.¹¹⁵ As the Supreme Court has cautioned, "it is at best treacherous to find in congressional silence alone the adopting of a controlling rule of law."¹¹⁶ It would seem that important activities of the United States Government deserve direct and specific authorization from Congress.

D. THE HOLTZMAN AND ABOUREZK AMENDMENT OF 1974

In 1974 Congress directly addressed the issue of the Central Intelligence Agency's conduct of covert action. In September, the House of Representatives defeated an amendment which would have forbidden the Central Intelligence Agency to spend funds "for the purpose of undermining or destabilizing the government of any foreign country." In October, the Senate defeated an amendment to the Foreign Assistance Act of 1974, which would have forbidden any agency of the United States Government to carry out "any activity within any foreign country which violates or is intended to encourage the violation of, the laws of the United States or of such countries," except for activities "necessary" to the security of the United States and intended "solely" to gather intelligence.

While both amendments would have limited the ability of the Central Intelligence Agency to conduct covert action, the failure of Congress to adopt them does not clearly constitute congressional ratification of the CIA's authority to conduct covert action.¹¹⁷ Neither dealt with covert action in general. Strong opposition to even their consideration prior to hearings and committee reports was voiced. The amendments, however, did signal an increasing congressional concern over covert action and marked the beginning of attempts by Congress as a whole to regulate and obtain information on covert action.

In September 1974, Representative Holtzman proposed a joint resolution which would have amended the Supplemental Defense Appropriations Act as follows:

After September 30, 1974, none of the funds appropriated under this joint resolution may be expended by the Central Intelligence Agency for the purpose of undermining or destabilizing the government of any foreign country.

¹¹⁴ The theory that congressional acquiescence constitutes ratification that can be easily stretched. J. Edwin Dietel, Assistant General Counsel of the Agency, wrote a memorandum for the record dated May 7, 1974. In it he described a question submitted by Senator Proxmire to Director Colby during Mr. Colby's nomination hearing which concerned the Agency's secret financing of political parties. Mr. Dietel wrote that in a classified response Mr. Colby stated that the CIA has, over the last twenty-five years of its existence, provided secret financial assistance to political parties in a number of foreign countries. "As there have been no reverberations from this statement, there is, at least, tacit approval for 'his type of activity.'"

¹¹⁵ *Thomas v. Clifford*, 408 F. 2d 134, 160. (D.C. Cir. 1968). See also, Norman Dorsen testimony, House Select Intelligence Committee, Hearings, 12/9/75, p. 1741.

¹¹⁶ *Clouard v. United States*, 328 U.W. 61, 60 (1940).

¹¹⁷ For a contrary view See Rogovin, HSC, 12/9/75, pp. 1730-1737.

Ms. Holtzman introduced the amendment in response to revelations about the efforts of the CIA to "destabilize and undermine the government in Chile" and as a "beginning" in "restoring congressional prerogatives over the activities of the Government of this country."¹¹⁸ Ms. Holtzman stressed her opposition to such activities directed against foreign governments with whom the United States was not at war "especially in an atmosphere of virtually complete secrecy, without approval by the Congress, or approval by the people of this country."¹¹⁹

The amendment was supported by Representative Giaino, who noted:

Since we have been informed of the improper activities of the CIA in Chile, and perhaps in other countries—and we have certainly been informed of its wrongful activities in Chile—this is the first opportunity which we have had in Congress to voice either approval or disapproval of the actions of our Government as they relate to the CIA. This is the first bill before us which presents us that opportunity. It is too late for us as a practical matter to do anything in the defense appropriation bill, but it is not too late now for us to approve this amendment, and to show to the world that the U.S. Congress will not sanction these nefarious and covert activities of the CIA, that the people of the United States will not approve and ratify the improper and wrongful acts of the CIA in Chile."¹²⁰

The amendment was opposed by Representative Mahon who argued that the bill was "irrelevant" because the defense appropriation bill would be signed into law within a few days,¹²¹ and because the legislation contained no proposal to undermine or destabilize any government.¹²² He described as "indefensible" the presentation of the amendment as there had not been sufficient hearing by any of the committees of the House.¹²³ He was joined in his opposition by Representative Cederberg, a member of one of the CIA oversight subcommittees in the House, who indicated his belief that U.S. activities in Chile were taken "in the best interest of the United States,"¹²⁴ and by Representative Conlan who argued that the amendment would lead to the identification of all our intelligence agents throughout the world and the destruction of the "basic defenses" of the United States. A vote for the amendment, Representative Conlan cautioned, would "cut off our covert intelligence operations" and "would be a vote for national suicide."¹²⁵

The proposal was defeated by the House of Representatives on September 30, 1974, by a vote of 291-108.

Given this debate the defeat of the amendment cannot be read as congressional ratification of the CIA's authority to conduct covert ac-

¹¹⁸ Cong. Rec. H9492-9493, daily ed., 9/24/74. (remarks of Rep. Holtzman).

¹¹⁹ Cong. Rec. H9492, daily ed., 9/24/74.

¹²⁰ *Ibid.*, p. H9493 (remarks of Rep. Giaino).

¹²¹ *Ibid.*, (Remarks of Rep. Mahon).

¹²² *Ibid.*

¹²³ *Ibid.*

¹²⁴ *Ibid.*, p. H9404 (remarks of Mr. Cederberg).

¹²⁵ *Ibid.*, (remarks of Rep. Conlan).

tion. The absence of hearings, the possible "irrelevance" of the amendment noted by both supporters and opponents of the bill, and the fact that the amendment only dealt with activities the purpose of which was the "undermining or destabilizing the government of any foreign country," all undercut an expansive reading of Congress' failure to adopt it.

On October 2, 1974 Senator Abourezk introduced an amendment (#1922) to the Foreign Assistance Act of 1974 which read as follows:

Illegal activities in foreign countries. — (a) no funds made available under this or any other law may be used by any agency of the United States Government to carry out any activity within any foreign country which violates or is intended to encourage the violation of, the laws of the United States or of such countries.

(b) The provision of this section should not be construed to prohibit the use of such funds to carry out any activity necessary to the security of the United States which is intended solely to gather intelligence information.

The amendment triggered a more extended floor debate than that generated by the Holtzman amendment.¹²⁶ During the debate Senator Abourezk asserted that his amendment would "abolish all clandestine or covert operations by the Central Intelligence Agency."¹²⁷ He argued that even the Director of the CIA had indicated that the national security would not be endangered if covert action were abolished.¹²⁸ Some of the opponents of the amendment argued that improved congressional oversight would be preferable to banning covert action. Senator Church noted that he could envision situations where threats to the national security would require covert activities.¹²⁹

The amendment failed of passage. It might be argued that this failure like that of the Holtzman amendment, constituted congressional ratification of the CIA's conduct of covert action.

The logic of this is undercut by a number of factors. One is that the amendment was not directed to all covert action, although the comments of some of the members implied that it was.¹³⁰ It was directed to activity abroad "which violates or is intended to encourage the violation of, laws of the United States or of such country." Thus, if failure to pass the amendment is to be read as congressional ratification of the actions which the amendment sought to prohibit, the Congress would have ratified only those foreign activities by the CIA which are illegal or intended to encourage the violation of law.

¹²⁶ See Cong. Rec. S18051-18056, daily ed., 10/2/74.

¹²⁷ *Ibid.*, p. 18051 (remarks of Sen. Abourezk).

¹²⁸ *Ibid.*

¹²⁹ *Ibid.*, (remarks of Sen. Church).

¹³⁰ Senator Abourezk stated that the amendment would "abolish all clandestine or covert operations," while Senator Church argued that increased oversight would be better than a complete prohibition. On the other hand, Senator Hatfield opposed the amendment as it did not go far enough in merely prohibiting the use of funds to carry out illegal foreign covert action; he argued that the capacity for any covert action should be taken away from the CIA. Senator Metzenbaum argued for the amendment's passage precisely because it was aimed only at illegal activities abroad by the CIA.

Whether the amendment passed or failed, it left unchanged whatever authority, if any, the CIA then had to conduct covert actions abroad which were illegal neither at home nor overseas.

Finally, the question of whether the amendment's failure should be read as congressional ratification of the CIA's authority to conduct such activities as would have been banned must be viewed in the light of other, and telling, arguments raised by those opposed to the amendment. Several Senators including Senators Humphrey, Stennis, and Goldwater objected to the fact that the amendment had not had the benefit of analysis by the committees with proper jurisdiction. Without the benefit of consideration by the Armed Services Committee, the amendment would be, according to Senator Stennis, "a shot in the dark."¹⁵¹

Using a different argument in opposition, Senator Baker stated that there existed "an insufficient state of information" by which to judge whether covert operations were or were not properly conducted. In place of the amendment he suggested that a proposed joint committee on intelligence oversight be established; Congress could then be supplied with sufficient information on covert action to make a judgment as to whether it should be banned or controlled by some other device.¹⁵²

Given the fact that the amendment would prohibit only those foreign activities by the CIA which were illegal, the lack of explicit authorization for the CIA to conduct any covert action, the opposition of a substantial number of Senators to the amendment's consideration before it was examined by the committees with appropriate jurisdiction, and the statements by certain Senators that not enough was known about covert action to take a position on its continuance, the amendment's failure can hardly be given much weight in determining whether Congress has ratified the CIA's authority to conduct covert action.

E. THE HUGHES-RYAN AMENDMENT

In 1974 Congress passed a significant amendment to the Foreign Assistance Act. The amendment provided that no funds might be expended by the CIA for operations not intended solely for obtaining necessary intelligence, in the absence of a Presidential finding that the operation is important to the national security of the United States, and a timely report to the appropriate committees of the Congress.

The amendment does not specifically authorize covert action by the CIA or unambiguously demonstrate congressional intent to provide such authorization. It does provide support for the position that Congress has authorized the CIA to conduct covert action or, more specifically, activities that are not intended solely for intelligence gathering. The debates indicate, however, a desire on the part of some Senators to withhold a decision on whether to authorize covert action until the reporting requirement provided Congress with more information.

¹⁵¹ See Cong. Rec. S-18052, daily ed., 10/2/74 (remarks of Sen. Stennis).

¹⁵² *Ibid.*, p. S18065 (remarks of Sen. Baker).

In December 1974, the Congress passed a set of amendments to the Foreign Assistance Act. The amendments provided inter alia:

Limitations on intelligence activities—(a) no funds appropriated under authority of this or any other Act may be expended by or on behalf of the Central Intelligence Agency for operations in foreign countries, other than activities intended solely for obtaining necessary intelligence, unless and until the President finds that each such operation is important to the national security of the United States and reports, in a timely fashion, a description and scope of such operation to the appropriate committees of Congress, including the Committee on Foreign Relations of the United States Senate and the Committee on Foreign Affairs of the United States House of Representatives (b) the provisions of subsection (a) of this section shall not apply during military operations initiated by the United States under a declaration of war approved by the Congress or an exercise of powers by the President under the War Powers Resolution.¹⁸³

The statute does not explicitly authorize covert action by the Central Intelligence Agency. On its face it leaves the question of congressional authorization for covert action by the Central Intelligence Agency in the same position as existed prior to its passage, with two exceptions:

(1) For the first time a statute passed by Congress and signed by the President acknowledges that the Central Intelligence Agency might, in fact, conduct operations which were not intended solely for intelligence-gathering purposes; and

(2) The statute required that if such operations were to be carried out the President must first find that they are important to the national security of the United States. If such a finding is made, the operations must then be reported in a "timely fashion" to the appropriate committees of Congress.¹⁸⁴

The amendment does not on its face provide any new authority for the President or the CIA. Nowhere in the public record is there any suggestion that the amendment might, in itself, serve as a new delegation by Congress of authority to the President to order any action by the CIA. If the amendment were read as a new delegation of powers to the President, the delegation would cover an enormously wide range of activities—all those activities not intended solely for intelligence gathering.¹⁸⁵

While there is no evidence in the public record that Congress intended to delegate new powers to the President or the CIA, it might

¹⁸³ Appendix D, Hearings, Vol. 7, p. 230.

¹⁸⁴ There is some question as to the meaning of a "timely fashion." It is not clear whether it means prior to, at the same time as, or within a reasonable time after, the initiation of such an operation. The Central Intelligence Agency has, on occasion, notified the appropriate congressional committees before initiation of a project. The Senate Select Committee has recommended that the appropriate congressional committees be notified prior to the initiation of any significant covert action projects.

¹⁸⁵ This would be limited, to some extent, by the requirement of a presidential finding.

be argued that passage of the amendment constitutes congressional acknowledgment that the CIA did have authority to conduct those covert actions consonant with the Presidential finding. The CIA has, in fact, taken the position that passage of the amendment "clearly implies that the CIA is authorized to plan and conduct covert action."¹³⁶ Two committees of the Association of the Bar of the City of New York concluded that passage of the amendment serves as a "clear congressional authorization for the CIA to conduct covert activities."¹³⁷ This argument has considerable merit.

While certain restrictions were placed on the conduct of covert action, it was not prohibited as it might have been. The amendment was described in the floor debates as permitting the CIA to engage in many activities and "authorizing" even covert activities such as those designed to "subvert or undermine foreign governments."¹³⁸

Congressional ratification or authorization, however, as demonstrated by the floor debates, was hardly unambiguous. A substantial number of the proponents of the amendment saw it as a temporary measure. As Senator Hughes, its sponsor, stated:

. . . the amendment I offer should be regarded as only a beginning toward the imperative of imposing some order and structure to the means by which the American people, through their elected representatives, can exercise a measure of control over the cloak-and-dagger operations of the intelligence agencies of the U.S. government.¹³⁹

He went on to say that the amendment "provides a temporary arrangement, not a permanent one, recognizing that a permanent arrangement is in the process of being developed."¹⁴⁰

The development of this "permanent arrangement" depended on the effectiveness of the reporting requirement. Senator Baker, who had opposed the Abourezk amendment because there existed "an insufficient state of information" by which to judge covert operations, and Senator Symington both described the Hughes amendment as an important step in providing Congress with much-needed information about the activities of the intelligence agencies.¹⁴¹ Thus the amendment might be seen not as congressional authorization for the CIA to conduct covert action but as a temporary measure placing limits on what the CIA would do anyway, while at the same time requiring reporting to Congress so that Congress as a whole, traditionally deprived of knowledge about covert action, could determine what action to take with respect to this activity.¹⁴²

¹³⁶ Rogovin, HSIC, 12/9/76, p. 1787.

¹³⁷ "The Central Intelligence Agency: Oversight and Accountability," prepared by the Committee on Civil Rights and the Committee on International Human Relations, of the Association of the Bar of the City of New York (1975) p. 15.

¹³⁸ Cong. Rec. H11027, daily ed., 12/11/74. (remarks of Rep. Holtzman.)

¹³⁹ Cong. Rec., S18062, daily ed., 10/2/74. (remarks of Sen. Hughes.)

¹⁴⁰ *Ibid.*

¹⁴¹ *Ibid.*, p. S18065 (remarks of Sen. Baker and Sen. Symington).

¹⁴² There is no evidence to support the view that Congress intended the amendment to serve as a *post hoc* ratification for all previous CIA activities not intended solely for intelligence gathering.

Proponents of this interpretation of the amendment can argue that a measure designed to gather information about an activity cannot be construed as congressional ratification of that activity. If it were, Congress would be powerless to seek regular reports about a controversial subject on which it had been ill-informed without such action being cited as congressional ratification for the subject of the reports.

The amendment did not directly address the question of congressional authorization for the CIA to conduct covert action. Its passage did not unambiguously demonstrate a congressional intent to authorize covert action. However, its passage supports the position that Congress has either provided the CIA with implied authority or ratified whatever authority the CIA possessed.

Congress clearly could have eliminated covert action. It chose, instead, to place certain limits on the CIA and to require reporting on covert actions to Congress. The reports to Congress should facilitate an informed legislative response to the issues raised by covert action. They also have the effect of preventing Congress from plausibly denying its own knowledge of covert action by the United States if questions of congressional authorization of covert action arise in the future.

Given the passage of the amendment and subsequent developments, particularly the hearings and reports of the House Select Committee on Intelligence, and the Senate Select Committee on Intelligence, there is little doubt that Congress is now on notice that the CIA claims to have the authority to conduct, and does engage in, covert action. Given that knowledge, congressional failure to prohibit covert action in the future can be interpreted as congressional authorization for it.

F. CONCLUSION

There is no explicit statutory authority for the CIA to conduct covert action. There is no substantial evidence that Congress intended by the passage of the National Security Act of 1947 to authorize covert action by the CIA or that Congress even anticipated that the CIA would engage in such activities. The legislative history of the CIA Act of 1949 similarly provides no indication of congressional intent to authorize covert action by the CIA.

The 1974 Amendment to the Foreign Assistance Act recognizes that the CIA does engage in activities other than those solely for the purpose of intelligence-gathering, i.e. covert action. Enacted following disclosures of CIA covert action in Chile, the amendment does provide support to the argument that Congress has authorized covert action by the Agency or has ratified the Agency's authority. (One of the purposes of the amendment, however, was to assure Congress the information about covert action necessary to decide what to do about it.)

Additional support for the argument that Congress has ratified the CIA's authority to conduct covert action would be provided by the continuing provision of funds to the CIA when it is clear that such funds will be used, in part, for covert action. Some support for the position may also be found in the continuing acquiescence of Congress in the executive branch's claim that court action has congressional authorization. While neither ratification by appropriation nor ratification by acquiescence are favored by the courts, they cannot be disre-

garded. In the past such claims were weak. A few individual members of Congress were kept informed about covert action but there were doubts about the knowledge of Congress as a whole. The claims are now more powerful because of the notoriety of the executive branch's claim of authorization by Congress and because Congress, in part due to the reports required since 1974 and House and Senate investigations, can no longer claim ignorance of covert action.

Given the present state of congressional knowledge any remaining ambiguity will be resolved—whether Congress acts directly or not.

Views of the inherent power of the President and the rightful role for Congress in the formulation, initiation, and review of U.S. actions abroad have changed since the establishment of the CIA and the enactment of the National Security Act in 1947. These changes are reflected in such legislation as the 1974 amendment to the Foreign Assistance Act. Whatever role evolves for the Congress in the future it must now take responsibility for the CIA's conduct of covert action, and for its results.

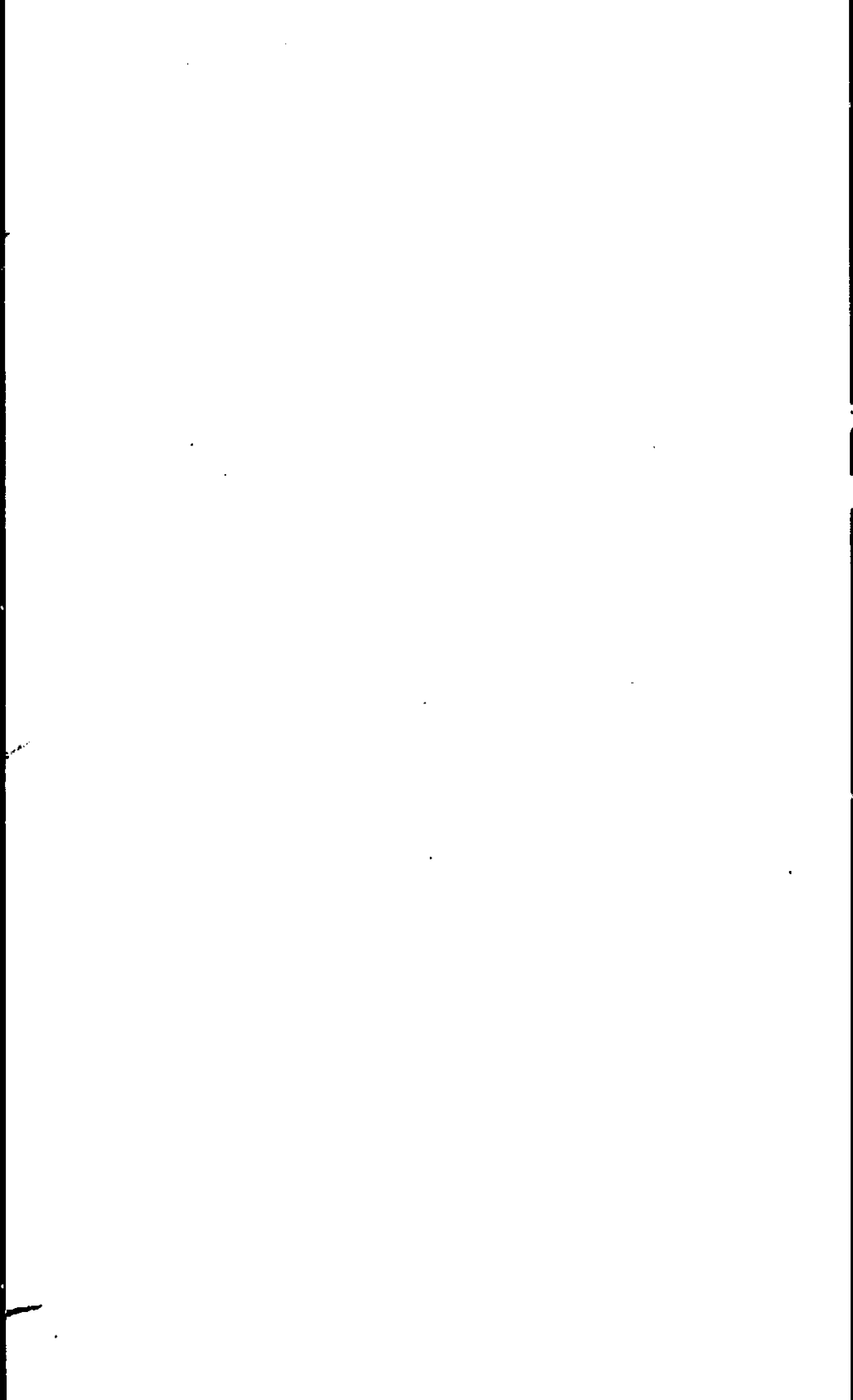

APPENDIX II

ADDITIONAL COVERT ACTION RECOMMENDATIONS

Throughout its inquiry, the Committee received numerous recommendations concerning covert action from many individuals and groups, including:

(a) Clark Clifford, former Counsel to President Truman, former Member and Chairman of the President's Foreign Intelligence Advisory Board, former Secretary of Defense;

(b) Cyrus Vance, former General Counsel, Department of Defense; former Secretary of the Army; former Deputy Secretary of Defense; former Special Representative of the President; former Member of U.S. Delegation to Paris Peace Negotiations;

(c) Morton Halperin, Director, Project on National Security and Civil Liberties; former Deputy Assistant Secretary of Defense for International Affairs; former Assistant for Planning, National Security Council Staff; former Senior Fellow, Brookings Institution;

(d) David Phillips, former Central Intelligence Agency employee; President, Association of Retired Intelligence Officers;

(e) Harvard University Institute of Politics, Study Group on Intelligence Activities. This group was established in September 1975, on the basis of an understanding between the Institute of Politics and the staff of the Select Committee to examine aspects of the National intelligence community's mission and structure. Its endeavor was an entirely voluntary one, with neither party having any former obligations to the other. The group met approximately 11 times between October 1975 and January 1976, and included Graham Allison, Philip Areeda, Francis Bator, Robert Bowie, John Bross, Morton Halperin, Philip Heyman, Ernest May, Jonathan Moore, Robert Pursley, Walter Slocombe, J. T. Smith, and Franklin Lindsay.

(f) The House Select Committee on Intelligence Activities;

(g) The Commission on the Organization of the Government for the Conduct of Foreign Policy (the Murphy Commission).

The Committee also considered suggestions made in numerous journal and magazine articles.

Selected statements, suggestions and recommendations from these sources follow.

A. STATEMENT OF CLARK M. CLIFFORD

I welcome your invitation to appear here today to discuss with your committee the problems surrounding the conduct of covert activities. The public has given much attention to this subject and a national dialogue has ensued. Some contend that it is necessary in the preservation of our democratic form of government to have a full disclosure of operations in this delicate area to ascertain if abuses have occurred. Others contend, with equal sincerity, that such an inquiry damages our country's image in the world and adversely affects the ability of our intelligence services to perform their tasks.

It is my opinion that the inquiry being conducted by this committee became absolutely necessary as the result of certain disclosures which demonstrated that gross abuses had occurred. Our country may sustain some temporary reduction in the effectiveness of its intelligence operations, but I consider this temporary in nature, and an appropriate price to pay in presenting the facts to the American people and in making progress toward the goal of preventing repetition of such abuses in the future. With the right kind of machinery, our country can take those actions which it believes necessary to help maintain freedom in the world and, at the same time, avoid the opprobrium that has been directed toward us as the result of improper activities in the field of clandestine and covert operations.

In 1946, President Truman stated that we must have a formalized intelligence agency. The lessons learned as the result of Pearl Harbor and increased tensions following World War II convinced him that we needed an institutionalized peacetime intelligence agency. As a result, the Central Intelligence Agency was created in the National Security Act of 1947.¹

Because those of us who were assigned to this task and had the drafting responsibility were dealing with a new subject with practically no precedents, it was decided that the act creating the Central Intelligence Agency should contain a "catch-all" clause to provide for unforeseen contingencies. Thus, it was written that the CIA should "perform such other functions and duties related to intelligence affecting the national security as the National Security Council may from time to time direct." It was under this clause that, early in the operation of the 1947 Act, covert activities were authorized. I recall that such activities took place in 1948 and it is even possible that some planning took place in late 1947. It was the original concept that covert activities undertaken under the act were to be carefully limited and controlled. You will note that the language of the act provides that this catch-all clause is applicable only in the event that the national security is affected. This was considered to be an important limiting and restricting clause.

¹ Appendix B, Hearing, Vol. 7, p. 210.

However, as the cold war continued and Communist aggression became the major problem of the day, our Government felt that it was necessary to increase our country's responsibilities in protecting freedom in various parts of the world. It seems apparent now that we also greatly increased our covert activities. I have read somewhere that as time progressed we had literally hundreds of such operations going on simultaneously.

It seems clear that these operations have gotten out of hand. The knowledge regarding such operations has become so widespread that our country has been accused of being responsible for practically every internal difficulty that has occurred in every country in the world. Our reputation has been damaged and our capacity for ethical and moral world leadership has been impaired. The need to correct this unfortunate development is long past due.

As one attempts to analyze the difficulty, and hopefully offer constructive suggestions for improvement, he finds much confusion existing within the system. It is clear that lines of authority and responsibility have become blurred and indistinct.

The National Security Council, under the Act of 1947, is given the responsibility of directing our country's intelligence activities. My experience leads me to believe that this function has not been effectively performed. The members of the NSC already have full-time jobs and do not have the time to oversee meticulously the actions of the intelligence community. Even though special committees have been set up from time to time to perform this task, we learn that many covert activities are undertaken without the knowledge of the National Security Council or its special committee. In the staff report on covert action in Chile,² the startling statement is made that only one-fourth of all covert action projects are considered by the 40 Committee.

Another condition exists that helps explain the unfortunate predicament in which we find ourselves. I believe, on a number of occasions, a plan for covert action has been presented to the NSC and authority is requested for the CIA to proceed from point A to point B. The authority will be given and the action will be launched. When point B is reached, the persons in charge feel that it is necessary to go to point C, and they assume that the original authorization gives them such a right. From point C, they go to D and possibly E, and even further, this has led to some bizarre results, and, when an investigation is started, the excuse is blandly presented that authority was obtained from the NSC before the project was launched.

I believe that the present system is no longer adequate to meet the task. The lack of proper controls has resulted in a freewheeling course of conduct on the part of persons within the intelligence community that has led to spectacular failures and much unfortunate publicity. A new approach is obviously needed for it is unthinkable that we can continue to commit the egregious errors that have caused such consternation to our friends and such delight to our enemies.

This inquiry today is part of the broad investigation conducted by this committee to ascertain the facts. This is a preliminary phase which hopefully will lead to recommendations that will help elimi-

² Appendix A, Hearings. Vol. 7, p. 144.

nate the errors of the past, and provide the country with the expectation that we can operate successfully in the future in this sensitive area with dignity and effectiveness. I know that this committee will be considering the means by which we can attain the improvement that is so necessary and is so desired by our people.

In this connection, permit me to present to the committee a brief five-point plan that I believe would make progress toward achieving our goal.

First, the 1947 law creating the CIA should be substantially amended and a new law should be written covering intelligence functions. We have had almost 30 years of experience under the old law and have learned a great deal. I believe it has served us reasonably well, but its defects have become increasingly apparent. A clearer, more definitive bill can be prepared that can accomplish our purposes. By creating clearer lines of authority and responsibility and by carefully restricting certain activities, we can hopefully prevent the abuses of the past.

Second, the creation of an effective joint House-Senate Committee to oversee intelligence operations. I consider this the most important function of a new law. Proper congressional oversight has been sadly lacking. I would hope that a small oversight committee of possibly five members of each chamber might be created. It should be considered an assignment of outstanding importance and the members should be willing to give the necessary time to it. By keeping the committee small, security can be maintained and the possibility of disclosures can be minimized.

With reference to covert activities, I believe it would be appropriate for this committee to be informed in advance by the executive branch of the Government before a covert project is launched. The committee should be briefed and, if it approves, then the activity can go forward. If the committee disapproves, it should inform the President of its disapproval so that he will have the benefit of the joint committee's reaction. If necessary, the President and the committee can confer, after which the President may decide to abandon the project or possibly modify it. If he persists in going ahead despite the committee's disapproval, then the committee might choose to withhold funds necessary to finance the activity in question. It is my feeling that the importance of the decisionmaking process in this very delicate field is such that there should be a joint effort by the executive and legislative branches.

I would assume that this committee will have questions in that regard, and I'm sure it will be valuable for us to discuss it.

Third, a new position of Director General of Intelligence should be created. This man would be the chief intelligence officer of the United States. It would be his responsibility to correlate and synchronize the activities of the various agencies within the intelligence community. Under this concept there would still be a director of the CIA, but his duties would be confined to the day-by-day operation of that agency. The Director General would be responsible for the product that would be produced by the intelligence community, and he would be the chief adviser to the President on intelligence matters.

The Director General would also be charged with the duty of seeing that the various agencies operated effectively and complied with the law. In this connection, he would have under him a number of inspectors who would assist him in carrying out this function.

Fourth, the decision regarding the undertaking of covert projects should be made by the Director General of Intelligence and the National Security Council, and he would have the responsibility of seeing that such covert projects were properly carried out by the CIA and other members of the intelligence community.

In the beginning, there was a separation between the CIA and the group charged with covert activities. In the early 1950's, they were consolidated. I believe that there should be much stricter control over the launching of covert projects, but that after the basic decision is made, then all the assets possessed by the CIA and other agencies should be utilized.

The close supervision provided for in this concept will inescapably diminish the number of covert operations. In my opinion, this is a highly desirable result. Many of the plans launched in the past should have been vetoed at their inception. I am sure that decisions have been made in the field that never would have been made in higher levels of our government. The guiding criterion should be the test as to whether or not a certain covert project truly affects our national security.

Fifth, the new intelligence agency should be forbidden to undertake any domestic operations except to police its own employees. There should not be any type of catch-all provision in the new law which would permit the intelligence agency to spy on American citizens. All domestic operations of this nature should be handled by the FBI. It is equipped to do it and a close cooperation between the CIA and the FBI is desirable and necessary. Certainly one agency charged with the responsibility of domestic surveillance activities is enough.

We have a big job to do in this country. Our people are confused about our national goals and cynical about our institutions. Our national spirit seems to have been replaced by a national malaise. It is my conviction that the efforts of this committee will assist us in regaining confidence in our national integrity, and in helping to restore to our Nation its reputation in the world for decency, fair dealing and moral leadership.

B. STATEMENT OF CYRUS VANCE

Mr. VANCE. I would like to speak briefly to what I believe is the central thrust of this committee's investigation: should there be any covert action? If so, what kinds and under what restraints?

At the outset, I think it is important to underscore the distinction between covert collection of intelligence and covert actions other than collection. I believe that with respect to covert collection of intelligence, the continuation of such collection should be permitted as I believe it is essential to the national security.

With respect to covert actions, I would not recommend that all covert actions be prohibited by law. I believe it is too difficult to see that clearly into the future. I believe it would be wise to enact legislation prohibiting involvement in assassinations, as has been suggested by this committee. In addition, I would be in favor of legislation prohibiting interference with the electoral processes in other countries. I would note that the drafting of such legislation is a complex business, and it would have to be so drafted as not to block covert intelligence collection.

Now, with respect to other covert actions, I believe it should be the policy of the United States to engage in covert actions only when they are absolutely essential to the national security.

The statutes, as now drafted, use the words "affect" or "are important to."³ I think those words are inadequate. I think covert actions should be authorized only when they are essential to the national security. Under such a test, I believe that the number of covert actions would be very, very small.

As to procedures to insure that such a policy would be carried out, I would suggest the following, and in the connection I might note that I agree with most of the recommendations that Mr. Clifford has made.

First, I believe that any proposal for a covert action should first go to the National Security Council, not a sub-Cabinet level committee. The highest level of the Government should focus upon the question, and therefore it should go before the National Security Council.

I would further suggest that the Attorney General of the United States be made a member of the National Security Council. This would insure that the chief legal officer of the United States would be one of those who would be passing upon the recommendation that goes to the President if it is in the affirmative.

I would also recommend that the President be required to give his approval in writing, certifying that he believes the proposed action is essential to the national security. After the President's approval, I would suggest that a full and complete description of the proposed action be communicated immediately to a joint Congressional oversight committee along the lines which Mr. Clifford has suggested. I believe that such a step would then put the committee or any of its members

³ Appendix B Hearings, Vol. 7, p. 210.

in a position to express their disapproval or concerns about the proposed action, and to communicate them to the President of the United States.

I am not suggesting that the committee should have a veto. I do not believe that is necessary. I am suggesting that the committee or its individual members would be able to communicate with the President, thus giving him the benefit of the committee's advice or of the advice of individual members.

I believe this is and would be important to Presidents. I do not believe there would be inevitable leaks from such a committee. I know that the Congress can safeguard security matters which are essential to our national security.

Finally, I believe it's necessary that a monitoring system be set up which would require frequent reports. I would suggest at least monthly to the highest level; namely, the National Security Council and the Congress and to the joint oversight committee as to the progress of any action which has been authorized to go forward. I think this would tend to help in meeting the problem that Mr. Clifford suggested with respect to a covert operation moving from A to B and then from B to C and so on.

Again, Mr. Chairman, I would stress that I believe such actions should and would be very rare and that under such a set of procedures there would be adequate oversight to control such activities.

C. STATEMENT OF DAVID A. PHILLIPS

Mr. PHILLIPS. Mr. Chairman and Senators, for the record I would like to make it clear that any viewpoints that I express today are personal ones. They do not represent the Association of Retired Intelligence Officers, an organization of intelligence people from all services, of which I happen to be President.

I would like to discuss covert action and covert activity. There's nothing new about covert action, the term which describes a variety of hugger-mugger gambits which can be taken to influence another nation's actions, attitudes, or public opinion.

What is new is the current controversy as to whether our country should engage in covert action. This is a valid subject for debate. Even though covert operations have been drastically reduced, American intelligence personnel realize that many of the problems which beset the intelligence community result from historical slips on the banana peels of covert action. The biggest banana peel of all is that vague phrase in the charter of CIA which reads "and other such functions and duties . . ." an ambiguous instruction which should be omitted from future legislation.

There are two dimensions to covert operations. The first is the major political or paramilitary endeavor, such as an attempt to change a government--Guatemala, for instance--or to finance a secret army in Southeast Asia. You might call this covert action with a capital "C," capital "A." King-size.

There is a second level of covert action, in the lower case; covert action with a small "c," small "a." I call this "covert activity." Little money, sometimes none, is spent on covert activity, where cooperative friends are persuaded to influence a foreign government or some element of it. The friend might be a government official responsive to an ambassador's off-the-record request, that the local government tighten up its laws concerning illegal narcotics traffic to the United States. When the friend is met clandestinely by CIA, he is called an "agent of influence." He might be a radio commentator or a local Bernard Baruch whose park bench opinions carry political weight. The agent of influence might be the foreign minister's mistress. Most covert activities utilizing the agent of influence are useful to American ambassadors in achieving low-key but important objectives of U.S. foreign policy. These activities are known in intelligence jargon as "motherhood," and revelations concerning them would not shock or disturb the American public. To proscribe CIA operations in covert activities would be imprudent.

Covert action, capital "C," capital "A", is another matter. In 25 years as a practitioner of covert action and covert activity in seven countries I have found that most of our mistakes occur when we attempt to persuade foreigners to do something which the United States wants more than they do.

The most successful operations have been those in which we were requested to intervene--the percentage of such operations, when a

foreign leader has asked for secret assistance, has been quite high. Some aspects of covert operations are anachronistic. Dirty tricks, such as besmirching the reputation of an individual, have been abandoned and should not be revived. The expensive accessories of covert action in the past, such as airlines and paramilitary units, should not and need not be maintained as secret capabilities.

There is a basic question to be answered: Given the distemper of the times, and the lack of credibility in government following Watergate, can covert operations remain covert? If not, they should be terminated. Macy's window is not the place for secret operations.

Some sort of compromise seems to be in order. If American intelligence operators demand secrecy as essential in covert operations, executive and congressional overseers have the even more important duty of knowing what intelligence agencies are doing.

I am convinced that the CIA is the organization best suited to carry out covert action operations. Despite this, I have reluctantly come to the conclusion that the charter for covert action should rest elsewhere. I say this more in sorrow than anything else. Effective and responsible accountability override practical operational considerations. This will be best achieved in the conduct of covert action by the creation of a new, very small bureau or office. By statute this organization would be staffed by no more than 100 persons.

Some 60 would be in a support role; perhaps 40 officers would be engaged in the planning for and, on request, the execution of covert action operations. All U.S. covert action eggs then, would be in one small basket, a basket which could be watched very carefully. Even if not utilized, such an office would be justifiable in terms of money and effort as a war plans unit, expandable in case of international conflict. A joint congressional committee should find such a unit easy to monitor, and the intelligence personnel working in it could then expect a reduced number of congressional overseers, as opposed to the six committees now observing covert operations.

The office I propose would call on expertise derived from experience. It would not employ airlines or mercenaries or exotic paraphernalia, but would need the capability to provide friends with imaginative advice and what British intelligence officers have sometimes called "King George's cavalry"—money.

Covert action is a stimulating business, a heady experience for those who sponsor it and for its practitioners. If not used in moderation it is as dangerous as any stimulant. But to suggest that covert action be abandoned as a political option in the future is, in my opinion, injudicious, if not frivolous. Some say that covert action should be abolished because of past mistakes. This would be as foolish as abolishing the Office of the President because it has been once abused, or to disband our army in peace time would be.

The committee is aware of the 2-year study recently conducted by the Murphy commission.⁴ A conclusion of this review that:

Covert action should not be abandoned but should be employed only where such action is clearly essential to vital U.S. purposes, and then only after careful high level review.

⁴ Report of the Commission on the Organization of the Government for the Conduct of Foreign Policy, June 1975.

D. PREPARED STATEMENT OF MORTON H. HALPERIN

Mr. Chairman, I consider it an honor and a privilege to be invited to testify before this committee on the question of covert operations. From this committee's unprecedented review of the activities of our intelligence agencies must come a new definition of what the American people will permit to be done in their name abroad and allow to be done to them at home. No problem is more difficult and contentious than that of covert operations.

It appears that I have been cast in the role of the spokesman on the left on this issue. It is an unaccustomed position and one that I accept with some discomfort. It should be clear to the committee that there are a great many thoughtful and articulate Americans whose views on this question are considerably to the left of mine, at least as these terms are normally used. I would not presume to speak for them. Nor, Mr. Chairman, am I speaking for the organizations with which I am now affiliated. I appear, as you requested, as an individual to present my own views.

I believe that the United States should no longer maintain a career service for the purpose of conducting covert operations and covert intelligence collection by human means.

I believe also that the United States should eschew as a matter of national policy the conduct of covert operations. The prohibition should be embodied in a law with the same basic structure as the statute on assassinations which the Committee has already recommended.

These proposals are not put forward because I believe that no covert operation could ever be in the American interest or because I could not conceive of circumstances where the capability to conduct a covert operation might seem to be important to the security of the United States. I can in fact envision such circumstances. However, I believe that the potential for covert operation has been greatly overrated and in my view the possible benefits of a few conceivable operations are far outweighed by the costs to our society of maintaining a capability for covert operations and permitting the executive branch to conduct such operations.

The revelations made by this Committee in its report on assassinations are in themselves sufficient to make my case. I will rely on these illustrations not because there are not many others of which we are all aware but rather to avoid any dispute over facts.

The case against covert operations is really very simple. Such operations are incompatible with our democratic institutions, with Congressional and public control over foreign policy decisions, with our constitutional rights, and with the principles and ideals that this Republic stands for in the world.

Let me begin with the last point. The CIA operations described in this Committee's assassination report are disturbing not only because murder was planned and attempted, but also because the operations went against the very principles we claim to stand for in the world. In Cuba, the Congo and Chile we intervened in the internal affairs of other countries on our own initiative and in the belief that we had the right to determine for others what kind of government their country needed and who posed a threat to their welfare. We acted not because we believed those that we opposed were the tools of foreign powers kept in office by outside intervention; rather we acted in the face of assertions by the intelligence community that the leaders we opposed were popular in their own lands.

In the Congo our efforts were directed at keeping Lumumba from speaking and keeping the parliament from meeting because we believed that allowing him to speak or allowing the parliament to meet would have meant that Lumumba would be back in office. In Chile we preached to the military the need to ignore the constitution and to overthrow a democratically elected government. We warned that the alternative was deprivation and poverty for the Chilean people.

All of these things were undertaken in the name of the United States but without the knowledge or consent of the Congress or the public. Nor could such consent have been obtained. Can you imagine a President asking the Congress to approve a program of seeking to reduce the people of Chile to poverty unless their military, in violation of the constitution, seized power; or the President seeking funds to be used to keep the Congolese Parliament out of session so that it could not vote Lumumba back into office; or the authority to promise leniency to Mafia leaders if they would help to assassinate Castro. These programs were kept covert not only because we would be embarrassed abroad, but also because they would not be approved if they were subjected to the same Congressional and public scrutiny as other programs. That is one major evil of having a covert capability and allowing our Presidents to order such operations. The assassinations themselves may have been an aberration; the means and purposes of our interventions were not.

Another inevitable consequence of conducting covert operations is that it distorts our democratic system in ways that we are only beginning to understand. Covert operations by their nature cannot be debated openly in ways required by our constitutional system. Moreover, they require efforts to avoid the structures that normally govern the conduct of our officials. One obvious area is lying to the public and the Congress.

We should not forget that the erosion of trust between the government and the people in this Republic began with the U-2 affair and has continued through a series of covert operations including Chile. Whether or not perjury was committed—and I see little doubt that it was—it is surely the case that the Congress and the public were systematically deceived about the American intervention in Chile. Such deception must stop if we are to regain the trust needed in this nation; it cannot stop as long as we are conducting covert operations. Given the current absence of consensus on foreign policy goals, such operations will not be accorded the deference they were given in the

past. Critics will press as they do now on Angola and Portugal. And administrations will feel the need and the right to lie.

Surely at this point in time it is not necessary to remind ourselves of the certainty that the techniques that we apply to others will inevitably be turned on the American people by our own intelligence services. Whether that extends to assassination has sadly become an open question but little else is.

The existence of a capability for covert operations inevitably distorts the decision making process. Presidents confronted with hard choices in foreign policy have to face a variety of audiences in framing a policy. This is in my view all to the good. It keeps us from straying far from our principles, from what a majority of our citizens are prepared to support, from a policy out of touch with reality. The overt policies of the American government ultimately come under public scrutiny and Congressional debate long before that they have been subject to bureaucratic struggles in which the opposition of the policy have their day in court.

Our intelligence analysts are free to explain why the policy will not work. With covert policies none of this happens. Intelligence community analysts were not told of the plans to assassinate Castro and so they did not do the careful analysis necessary to support their view that it would make no difference. The Assistant Secretary of State for Latin America was kept in the dark about Track II in Chile so he was not able to argue against it and inadvertently deceived the public.

In fact, I would argue that the route of covert operations is often chosen precisely to avoid the bureaucratic and public debate which our Presidents and their closest advisers come to despise. That is precisely what is wrong with them. Our Presidents should not be able to conduct in secret operations which violate our principles, jeopardize our rights, and have not been subject to the checks and balances which normally keep policies in line.

You will hear, I am sure, various proposals to cure these evils by better forms of control. Such proposals are important, well-intentioned and certainly far better than the status quo, but I have come to believe that they cannot succeed in curing the evils inherent in having a covert capability. The only weapon that opponents of a Presidential policy, inside or outside the executive branch, have is public debate. If a policy can be debated openly, then Congress may be persuaded to constrain the President and public pressure may force a change in policy. But if secrecy is accepted as the norm and as legitimate, then the checks put on covert operations can easily be ignored.

Let me conclude by violating my self-imposed rule to draw only on cases in the assassination report and discuss some rumored current covert operations. I ask you to assume (since I assume that the Committee is not prepared to confirm) that the United States now has underway a major program of intervention in Angola and a plan to create an independent Azores Republic should that prove "necessary". I ask you to consider how the Congress and the public would treat these proposals if they were presented openly for public debate. Congress could, in principle, vote publicly to send aid to one side in the Angolan civil war as other nations are doing and we could publicly invite the people of the Azores to choose independence and gain our support.

But because we maintain a covert operations capability and because such operations are permitted, the President can avoid debate in the bureaucracy and with the Congress and the public. We can be drawn deeply into commitments without our consent and have actions taken on our behalf that we have no opportunity to stop by public pressure or to punish at the polls.

Mr. Chairman, in response to the position I have outlined briefly this morning, one is confronted with a parade of hypothetical horrors—the terrorists with the nuclear weapons, a permanent oil embargo and the like. To these I would reply in part that such scenarios seem implausible and should they occur the likelihood that covert capabilities could make an important difference also seems remote. As to the consequences of legislating a total prohibition in light of the possible unexpected catastrophe, I am content to call your attention back to the committee's excellent treatment of this issue in your assassination report.

This country is not, in my view, in such dangerous peril that it need continue to violate its own principles and ignore its own constitutional system to perpetuate a capability which has led to assassination attempts, to perjury, and to the subversion of all that we stand for at home and abroad. We are secure and we are free. Covert operations have no place in that world.

E. RECOMMENDATIONS OF THE HARVARD UNIVERSITY INSTITUTE OF POLITICS, STUDY GROUP ON INTELLIGENCE ACTIVITIES, FOR REFORM IN THE CONDUCT OF COVERT OPERATIONS AND SECRET INTELLIGENCE TO PROTECT THE BASIC INTEREST AND INTERNATIONAL STANDING OF THE UNITED STATES

Additional safeguards are needed to govern intelligence collection and covert operations in respect to activities that can discredit (1) the United States' objectives, principles and interests; (2) private individuals and institutions within the United States (in addition to constitutional protections); and (3) foreign and international institutions and persons important to the United States. Because of the secret character of these activities, a "surrogate" system of safeguards must be established for the normal safeguards of public scrutiny and open debate accompanying overt government activities. These surrogate procedures include the promulgation of basic guidelines, the strengthening of review and approval procedures within the executive branch, and the proper functioning of the congressional oversight function.

We believe that some capacity for covert operations needs to be preserved and available in suitable circumstances.¹ Thus, such operations should not be abolished or prohibited completely, but should be better regulated and supervised. It is not easy to prescribe rigid rules regarding covert operations. Within limits what is suitable or even permissible will vary with circumstances. Measures which should not be undertaken in peace time or against a democratic state might be permissible during actual or threatened hostilities or against a totalitarian regime. Thus, it would be unwise to freeze safeguards by the rigidity of legislative prohibitions. There is need for some flexibility to adjust to circumstances and to modify rules and procedures according to changes in conditions and experience. Guidelines to govern covert operations should thus be incorporated into executive orders in preference to legislation. The Congress should direct the executive branch to promulgate such orders and might propose the areas they should cover.

1. *Principles to Govern Covert Operations, and to Govern Secret Intelligence and Counterintelligence to the Extent That the Principles Are Applicable*

a. Covert operations must be consistent with, and in support of, openly announced policies and objectives which have been established by the normal processes of government.

b. At best, covert operations can provide tactical support for long-term national policies openly arrived at and openly executed.

¹ Morton Halperin believes that no clandestine operations should be permitted.

c. Covert operations must not be used as a convenient escape from public review, nor to circumvent overt procedures for policy approval where it is possible to accomplish the objective by overt means.

d. Covert operations in peace time should ordinarily be directed to actions which will basically contribute to the strengthening of open societies and to the resolution of international conflicts.

e. Some covert operations can only be justified in war or near-war situations where the security of the United States is directly involved, and where both the probability of exposure and the price of exposure are much less than in peace time.

f. In the present situation, large-scale operations, such as the support of guerrilla forces, which can neither be kept secret nor plausibly denied, should not be undertaken covertly.

g. No covert operations shall be undertaken with the objective of assassination, murder, terrorism or mass destruction (such as creating epidemics or causing food shortages). No clandestine support shall be given knowingly to political or other groups for such purposes, and positive efforts shall be made to prevent any support provided by the United States from being used by others for such purposes. No covert support, advice or assistance will be given to police or other forces used for internal security purposes that systematically use torture, concentration camps, etc. On the other hand, covert relationships have in the past been used to moderate the activities of foreign security forces, and this should not be prohibited. The receipt of information from foreign security forces would not, of course, be barred, but the provision of information to them about their "targets" would be. There is not a consensus on this point; some believe that it is too narrow in application (since funds given covertly or overtly for other purposes would free resources for the tortures); others believe it is impractical, given the need to exchange information and contacts with foreign services regardless of their unsavory domestic practices.

h. Covert operations shall not be used to subvert the results of the democratic processes of other countries. (1) This principle would not, in itself, bar covert funding of open political parties or organizations where the opposition is receiving foreign funds. However, in countries with democratic processes, covert operations should be restricted to backing organizations with genuine prior existence and support within the country; they shall not be used to create groups which would not exist on any significant scale without U.S. backing. (2) This principle will not, in itself, bar covert operations where the government in power—though initially democratically installed—is clearly engaged in destroying those processes. However, the other limitations on covert activities would remain in force.

i. Covert acts of war (coup-staging, guerrilla support, terrorism, training of mercenaries, aerial bombing) should not be undertaken except with congressional approval exercised through the Oversight Committee or Committees (since War Powers Act requires Congressional approval of overt acts of war).

j. Members or employees of private organizations whose integrity can be regarded as major independent national assets should not be used to provide cover for covert agents; nor should such organizations

themselves be used as vehicles for covert operations. The losses, through compromise, in the public acceptance of these groups as independent private activities or as overt government activities, is almost always far greater than the gain from using them as cover for intelligence agents. The types of organizations which should be included in such prohibition are:

- religious organizations;
- the press;
- charitable and educational foundations;
- universities and colleges;
- the Peace Corps and similar government agencies; and,
- any person who is abroad as a scholar, teacher or adviser with overt U.S. Government support.

This prohibition should not exclude such organizations or individuals from transmitting information to overt or covert agencies of the government when it is gained through the normal activities of these organizations.

2. Procedures for Approval of Covert Operations by the Executive Branch

The procedures of the executive branch for review and approval of covert activities must be strengthened. Since it is recognized that in the world in which we live, not all activities of the government can or should be conducted in the full light of public disclosure, a "surrogate" must be established for the normal public scrutiny and open debate accompanying over government actions.

The surrogate procedures must be rigorously defined and followed, and must be equivalent to the impartial scrutiny and judgment that is applied to overt policies through executive branch review and public consideration, congressional debate and legislative action. We recommend that no clandestine action (including not only covert operations but also major secret intelligence projects) should be undertaken except pursuant to the following:

a. The President should appoint a permanent Special Committee to examine and advise on all clandestine activities. The members of the committee should be publicly identified and the Chairman should be appointed by the President and confirmed by the Senate. It should have a small, independent staff.

b. This Special Committee should be composed of persons of broad international or public policy judgment and experience, or both. They should have the freedom from personal political commitments and ambitions and should have sufficient time available to examine any proposed action with whatever degree of time and attention is required to evaluate both the likelihood and the long-term and short-term implications of either success or failure. Further, they should be able to review in whatever depth necessary the intelligence estimates underlying the proposed action and independently assess the likelihood of success and the likelihood of exposure. They need not be full time but they should not have other government responsibilities.

c. All proposals for covert operations should be submitted to the Special Committee in writing and should:

- (1) state the objectives and the specific actions planned;
- (2) show the conformity to the executive order guidelines and overt U.S. policies;
- (3) assess alternative overt means available;
- (4) appraise the prospects for success and the consequences of either success or failure.

d. Any such proposal should be submitted to the Special Committee for appraisal before submission to the President. He should not authorize any such action before he receives the report from the Special Committee showing those approving, those dissenting, and those absent. The Report should make specific findings as to compliance with the guidelines. No proposed action should be undertaken until specifically approved by the President in writing. If he decides to approve the proposal, despite the objection of the majority of a Special Committee, he should set forth his reasons for acting contrary to their advice.

e. The Special Committee shall periodically review all on-going covert operations and major secret intelligence activities to ensure that the original justifications remain valid and that the activities shall conform to the executive order guidelines and should report their findings to the President. The committee should be required to approve continuation, at each review, failing which approval, the President would be required to re-authorize the operation, and should advise the Special Committee of his reasons.

f. Exceptions: When the United States is engaged in hostilities, or is endangered by imminent hostilities or other major threats to its security, the President may approve of specific covert operations directed against the enemy, potential enemy, or other source of threat contrary to the guidelines if he makes explicit findings in writing regarding the conditions justifying the action and files them both with the Special Committee and Oversight Committee of Congress.

3. The Role and Functions of Congressional Oversight Committee

a. The function of Congressional Oversight should ideally be centralized in a single joint committee of Congress, but at most in one committee in each branch of the Congress, in order to minimize duplicating or overlapping responsibilities with present standing committees.

b. Our study group believes that, in principle, the Oversight Committee should be informed of any proposed covert operation before it is undertaken and should be provided with the evaluation of the operation and recommendations of the Special Committee in the executive branch which is recommended above. However, the viability of the principle of advance notification will depend in the long run on the rules for secrecy the Congress imposes on itself and on the effectiveness of these rules in preventing unauthorized disclosure of secret and sensitive information.

Note by Robert Pursley: The Oversight Committee should attempt to ensure that the intelligence community is (1) doing the job effectively; (2) performing efficiently, i.e., costs and benefits are balanced; and (3) acting consistently with foreign policy.

Comment by the Chairman:

I believe all members of the study group would agree with this. However, since there was not time to consult them, the statement is included as a note rather than in the text.

4. *Organizational Alternatives for the Clandestine Services*

a. *Alternatives.*—There are four alternatives for location of the clandestine services (CS) of the CIA (in this outline the term clandestine services is used in preference to either DDO or DDP in order to avoid confusion):

1. State Department—The CS could be moved to the State Department and either be consolidated with State Department functions or be organized as a quasi-independent agency under a State Department umbrella (the ACDA model).

2. Department of Defense—The CS could be made a civilian operating agency of the Department of Defense reporting to the Secretary of Defense.

3. Independent Agency—The CS could be established as an entirely independent agency of Government reporting to the President through the National Security Council.

4. Status Quo—The CS could be maintained as part of a central intelligence function. Presumably its size and mission would be reduced.

b. *Assumptions.*—To discuss the above options rationally, one must make certain assumptions about the future need of the United States for CS. This outline assumes that we will want to maintain: a clandestine collection capacity; an international counterintelligence capability; and an ability to engage in some traditional covert action functions, but that the actual level of covert action will be drastically reduced. It also assumes that we will want our clandestine collection, counterintelligence and covert action capacities to be targeted as efficiently as possible and controlled as tightly as possible. Further, it is assumed that such functions will benefit from improved cover and other safeguards to clandestinity.

c. *A Note on the Clandestine Services.*—

1. General public opinion stimulated by the Agee book, etc., seems to be that the CIA has engaged in practically wanton intervention in the domestic political affairs of other countries and that this intervention has been a self-sustaining goal of our foreign policy. For the most part, America's "intervention" has been motivated by a desire to thwart real or predicted intervention by others—the Soviet Union, China, Cuba. Arguably our policy has been as much or more "counter-interventionist," as "interventionist."

2. It is often forgotten that the CS is not organized solely on geographic lines. A Soviet Bloc division has traditionally stationed case officers in any country there is a Soviet

"presence." The chief purpose of these "specialists" has been to monitor the activities of their KGB counterparts. Informed (though not necessarily unbiased) sources report that "detente" has brought no abatement of KGB activity in Europe, Japan or the less developed countries. This "KGB matching and monitoring" function should probably be at the core of any future CS.

3. Other appropriate roles for the CS include monitoring the activities of internationally operating terrorist groups and exploring third world political intentions regarding economic controls of scarce natural resources.

4. The above functions cannot readily or completely be carried out by overt United States representatives abroad. Such representatives are constrained, as a general proposition, to relations with established elements in the host country. Clandestine representatives can more readily explore the plans of opposition elements. Further, CS officers have carried out important liaison functions with intelligence services of host countries. It is assumed that such liaison should be continued through the CS.

d. A Note about Organization.—The CIA is frequently discussed as though it has two component parts—a CS and a directorate of intelligence, which does analysis, estimating and intelligence production (DDP/DDO and DDI). In point of fact, the Agency traditionally has operated with four directorates. In addition to the DDI and the CS, there have been a support directorate (DDS) and a directorate chiefly concerned with science and technology (DDS&T). The DDS contains a very substantial communications component which not only handles communications for the CIA but also, in many parts of the world, for the State Department. The DDI has contained two major "collection" functions—the Foreign Broadcast Information System (FBIS) and the Domestic Contact Service (DCS). The latter, which overtly contacts Americans who travel abroad in order to pick their brains regarding foreign technical and economic developments has been an important source of intelligence. Any rational plan for "divorcing" the CS and the DDI must perforce include consideration of disposition or re-creation of the functions and capacities which reside in the other two directorates (the DDS and the DDS&T), as well as the DDI collection functions (FBIS and DCS).

e. Goals or Principles.—Any scheme of organization for the CS should be based upon certain rational goals or principles, though it is impossible to define principles that are entirely consistent with one another. Some suggested principles are set forth below:

1. A responsive and effective intelligence analytic function is vital to the United States—the effectiveness and objectivity of this function should not be compromised by operational considerations; nor should its ability to gain the widest possible input be jeopardized by stigmatization which may result from proximity to covert activities.

2. The requirements of the analytic function should be readily communicated to the clandestine collector. Likewise, the

product of the clandestine collection system should be readily communicated to the intelligence analyst.

3. When appropriate, the President and other policymakers should receive raw clandestine intelligence from an agency that is as disinterested a conduit as possible.

4. The CS should be insulated from political misuse or from Presidential zeal, real or apparent.

5. Clandestine functions should be made as accountable as possible to public representatives, recognizing that secrecy can be a legitimate operational imperative.

6. The "cover" under which clandestine collectors operate should be preserved or improved.

7. The location of the CS should enable continuing evaluation of the relative merit of human intelligence as opposed to technical intelligence.

f. The following is an evaluation of the pros and cons of various alternative locations for the CS in light of the assumptions, organizational considerations and goals discussed above.

1. *The State Department Option—*

a. *Pro's*

(i) Might create better unity of foreign service and clandestine reporting, reducing redundancy of effort.

(ii) Might enable better integration of intelligence and foreign policy requirements in general.

(iii) Would enable establishment of independent intelligence analytic function without overlay of operational concerns.

(iv) Would involve placing State's communications back in the State Department.

b. *Con's*

(i) Traditional jealousy or suspicion of foreign service officers toward their CS counterparts might cause substantial bureaucratic friction.

(ii) Insulation from political aberration (*e.g.*, the McCarthy period) which in the past had not existed for the State Department might no longer exist for the CS.

(iii) To the extent the CS is called on to perform "covert" functions, the "taint" which these functions are said to place upon the intelligence analytic function could, in effect, be transferred to the entire foreign affairs establishment of the United States Government.

(iv) There may be a penalty in terms of responsiveness of collection to intelligence requirements if clandestine collectors and intelligence analysts are "divorced."

(v) To the extent the CS collects important intelligence information which contradicts DOD perceptions, DOD might claim CS is infected with a "State Department" bias.

2. *The Defense Department Option—*

a. *Pro's*

(i) In terms of size, the DOD could easily envelop the CS.

(ii) A considerable portion of CS cover is already military in nature. Thus there might be some marginal improvement in cover.

(iii) Location in the DOD would not result in a "tainting" of the DOD since it already engages in intelligence and counterintelligence functions.

(iv) Support and R&D functions for CS could readily be merged with DOD components.

b. *Con's*

(i) A Secretary of Defense's span of control is already very wide--query whether he would have the capacity to give adequate direction to the CS.

(ii) Might result in an increasing focus on military-to-military intelligence liaison as opposed to civilian lines of liaison. Such a change in focus may cause problems for command and control, and potentially can affect intelligence production.

(iii) Insulation from political zeal might very well be imperfect because of the traditional military attitude of "can do."

(iv) Civilian control at DOD of military functions is surprisingly "thin." Presumably the CS, if placed in the Pentagon, would be subject to civilian rather than military control and would tax an already overextended group of civilians.

(v) The intelligence reporting of the CS might become tainted by a military bias, real or perceived.

(vi) Because of the size of the DOD, the thinness of civilian control over DOD functions, etc., the net result of placing the CS in the Defense Department might well be to reduce, rather than enhance, CS accountability to the public and Congress.

3. *The Independent Agency Option--*

a. *Pro's*

(i) If it is deemed imperative to split the CS from the intelligence analytic functions of Government, the independent agency model would seem preferable to the State Department or Defense Department models in light of the "cons" outlined above.

(ii) The independent agency would presumably not be a large agency, at least in relative terms. It might give public assurance that the national policy is not being dominated by a clandestine intelligence colossus.

(iii) Tasking of this agency by the NSC directly might avoid the bias or inefficiency which might result in tasking it through the State Department on the one hand or the Defense Department on the other.

b. *Con's*

(i) Cover problems would result. Stateside cover would be difficult without a broader institutional envelop. The small size of the Agency might reduce "clout" in seeking cover slots from other Departments. This fact in turn could create incentives to use of commercial or even "media" cover with attendant societal costs.

(ii) The new agency would be less insulated from Presidential zeal.

(iii) An entire support mechanism would have to be created for this new agency.

(iv) Relationships of such an agency to the science and technology of intelligence collection would be unclear unless it were to have its own costly R&D function.

(v) It might require its own independent communications function.

4. *The Status Quo--*

a. *Pro's*

(i) Current location can assure closest tailoring of clandestine activities to intelligence analytic requirements assuming adequate direction and control.

(ii) The status quo is an evolutionary product which may reflect the wisdom of time.

(iii) It is hard to find a better location.

(iv) Present location is efficient from the point of view of using extant support, communications and R&D functions.

(v) Present location preserves independence of the clandestine function from potential military bias.

b. Con's

(i) The CS has been the dominant directorate in the agency and without a "divorce" this domination cannot be terminated.

(ii) History demonstrates that the present location inadequately insulates from the possibility of Presidential zeal.

(iii) Location of clandestine operations in the same agency charged with analytic and estimative functions may have warped and may continue to warp the intelligence product.

(iv) The status quo may be intolerable in light of the disclosures of the Senate Intelligence Committee. One can argue that a shake-up is needed for the sake of a shake-up.

g. Conclusions

1. On balance it seems that the status quo, however imperfect, is preferable than any of the three identified options for change. If the status quo is maintained, there nonetheless need to be serious changes within the current organizational arrangement:

a. By executive directive or by legislation, a career CS officer should be precluded from appointment as the principal intelligence officer of the U.S. Government.

b. Covert action should be dramatically circumscribed (if it has not already been as a practical result of the House and Senate intelligence committees' hearings and other recent disclosures and legislation).

c. The CS should be substantially reduced in size—the CS should be a more tightly focused operation, focusing on Soviet and Chinese targets and possible other targets of clear and continuing significance to the United States national security, such as resource cartels, and international terrorist activities.

d. To these ends, the CS must be given more rigorous intra- and inter-agency budget and planning scrutiny. Closer evaluation of the CS intelligence product needs to be made. DDI and DDS&T analysts should be required on a quarterly basis, to estimate the usefulness of CS reporting in terms of its percentage contribution to finished intelligence product.

**F. RECOMMENDATION OF THE HOUSE SELECT COMMITTEE ON
INTELLIGENCE CONCERNING COVERT ACTION**

1. The Select Committee recommends that all activities involving direct or indirect attempts to assassinate any individual and all paramilitary activities shall be prohibited except in time of war.

2. The Select Committee recommends that as to other covert action by any U.S. intelligence component, the following shall be required within 48 hours of initial approval.

a. The Director of Central Intelligence shall notify the Committee in writing, stating in detail the nature, extent, purpose, risks, likelihood of success, and costs of the operation.

b. The President shall certify in writing to the Committee that such covert action operation is required to protect the national security of the United States.

c. The Committee shall be provided with duplicate originals of the written recommendations of each member of the 40 Committee or its successor.

3. All covert action operations shall be terminated no later than 12 months from the date of affirmative recommendation by the 40 Committee or its successor.

G. AMERICA'S SECRET OPERATIONS: A PERSPECTIVE

By Harry Rositzke

[From Foreign Affairs Magazine, January, 1975]

I

Thirty-three years after William J. Donovan set up the first genuine American secret service, and as the first generation of American secret operations officers fades away into unclassified retirement, the American Intelligence Service, or AIS,¹ faces a new Administration, new tasks in a new non-confrontation world, and new, as well as old, suspicions. Its belated establishment led initially to a certain amount of hostility both within the foreign affairs establishment and vis-a-vis the internal security organization that had come into being after World War I, and these feelings have never wholly died out. And American secret operations have developed in their brief career an unenviable public image as well, both domestically and abroad.

Designed to cope with the Nazi, then the Stalinist, menace, the AIS has come to be regarded by liberal opinion at home as a haven for reactionaries and stunted cold warriors, as a sinister secret arm of our foreign policy, as a rapist of American civil rights and academic freedom, as co-conspirator with the White House in political skull-duggery. Abroad, "CIA" has become a symbol of American imperialism, the protector of dictators, the enemy of the Left, the mastermind of coups and counter-coups in the developing world. It is a strange and remarkable record for an official institution in a democratic society.

What is the action record of American secret intelligence? Where does it stand today? What lies ahead?

II

During World War II the Donovan organization attained, on the whole, a remarkable reputation. Kept out of the Southwest Pacific by a jealous General MacArthur, yielding Latin American responsibilities for the time being to the FBI, occasionally flawed by the high degree of individualism Donovan encouraged, the Office of Strategic Services (OSS) nonetheless rendered signal service in a host of situations. It left a large legacy not only of trained men but of senior officials convinced that such operations could be of great importance in supporting American foreign policy.

For two years after the war the survivors of OSS fought for their official lives. The former Research and Analysis Unit, essentially overt,

¹ I choose this simple term to distinguish the Service sharply from the Central Intelligence Agency (of which it is a lesser part) and to avoid the glut of titles by which it has been designated: Special Operations, Policy Coordination, Plans, Clandestine Services, Operations.

wound up briefly in the State Department, while the secret operations fended for themselves. In 1947 the two were brought back together under the umbrella of the Central Intelligence Agency, established by law in the summer of 1947, a marriage of covert and overt that persists to this day.

Those engaged in secret espionage operations found their main target within months of the end of the European war: Soviet military capabilities and intentions. By 1948, as the Berlin blockade signaled the intensification of the cold war, the overriding purpose of the AIS was to provide the White House with early warning of Soviet hostilities, both by strategic bombers and by ground troops through Poland.

In 1946 Washington knew virtually nothing about the U.S.S.R. Four years of concentration on the Germans and Japanese had left the Soviet files empty. Air Force researchers combed the Library of Congress to flesh out the bare outlines of bombing target dossiers. Tens of thousands of Eastern emigrés in Europe were interrogated for the simplest items of basic intelligence: roads, factories, city plans. Intelligence peddlers sprang up by the dozen to satisfy the American market. Any ship that visited a Soviet port was a gold mine.

Almost nothing came out of Moscow. A beleaguered embassy and a few sequestered Western journalists passed on official handouts, read the press, went nowhere, talked to no one. The Soviet Union, like Hitler's Fortress Europe, had become a "denied area." Only secret agent operations carried out by "illegal" entry could penetrate the target area to provide early warning of an attack and, later, information on Soviet progress in its atomic program.

For almost ten years, until the mid-1950s, the AIS dispatched agents into the Soviet Union by air, land and sea from almost every point on its outer periphery between Scandinavia and Japan. Most were equipped with radios and sent in by air, some to make contact with resistance groups in the Baltic States and in the Ukraine (where they survived until the mid-fifties), others to become observers at selected transportation points to give notice of unusual movement, or to collect or measure earth and water samples near suspect uranium-processing plants. A few tried to legalize themselves for permanent residence in urban areas. Agents without radios went on brief in-and-out missions on foot to observe, photograph, and exfiltrate.

At the same time hundreds of agents were being sent in to cover military targets in Eastern Europe from bases in adjacent areas. Border-crossing became the order of the day, easiest from Berlin, more and more dangerous elsewhere as the barbed wire, plowed strips, and alarm systems made the Iron Curtain more dense. Agents were sent in to observe specific airfields or factories, to make contact with old friends and recruit likely prospects, to establish themselves in strategic locations, to act as couriers, to service dead drops, etc.

These cross-border operations involved enormous resources of technical and documentation support, hundreds of training officers, thousands of safe-houses, and, above all, hundreds of courageous men who preferred to fight the Russians or the Communists rather than linger in the DP camps or emigrate to Brazil. Scores of agents paid with their lives for our concern. All this effort, however wasteful in retrospect, was demanded by the requirements of the Pentagon and the field com-

manders in Europe. Their demands reflected the almost frantic fear of a Soviet military move into Western Europe, especially after Korea.

With Stalin's death in 1953 and the easing of legal travel into the Soviet Union and Eastern Europe, the lessening urgency of ground military requirements, and the increased focus on Soviet political intentions, the emphasis in AIS operations shifted to the "legal" approach, the classic form of peacetime penetration. The Soviet official stationed abroad became one target, as his connection with Moscow and eventual reassignment to his headquarters made him a source of the greatest potential value: an in-place agent in or near the corridors of central power in the Party-government. The main agent source on Soviet matters during the fifties was a Soviet military officer whose reporting from 1953 to 1958 provided the U.S. government with detailed documentary information on strategic as well as tactical military matters, including the Berlin crisis. He was succeeded in the crucial years 1961-63 by Colonel Penkovsky, whose coverage of Soviet missile development was of vital strategic value.

From the late 1950s on, agent coverage of military-industrial targets within the Soviet Union was gradually superseded by both photographic and electronic coverage, which in terms of importance and volume far exceeded reporting through human sources.

American operations against Communist parties during the early years of the cold war were mainly designed to uncover their sources of secret funds, to ferret out their underground apparatus, and to establish their paramilitary capabilities and plans. On the political side, an occasionally valuable insight into the councils of Party leaders in Moscow came from their contacts with senior and respected Communist party leaders abroad.

After the 20th Party Congress in 1956, with the shift from direction to persuasion in Moscow's relations with foreign parties, more and more serious political discussions with foreign party leaders took place in Moscow. Senior party officials from Europe, Asia and Latin America became a useful source for the political views and regional intentions of the Soviet leadership. In the past 15 years the penetration of parties in these areas has served, for example, to supply details of the Sino-Soviet rift long before it became public, to record the underlying rationale of Soviet policy toward the Asian subcontinent, and to monitor the advice given the Arab parties during the various Near East crises.

From the late fifties the requirements for intelligence coverage broadened rapidly. Mideast tensions, troubles on the Indian subcontinent, heady events in Africa, the spurt of Chinese activity abroad in the mid-sixties, Castro's overseas programs, coups and counter-coups on four continents, the evolving situation in Indochina—all became grist for Washington's intelligence analysts and targets for agents' coverage.

The U.S. intelligence community soon became a global city desk to support the role of global policeman. The policy-makers wanted to know what was going on everywhere. The intelligence analysts set requirements and priorities that justified the collection of almost any information. Good researchers are omnivorous, and the man on "Paraguayan political" wants to know as much about goings-on in Asuncion as the Czech specialist about affairs in Prague. In the intelligence

sector, as in the public media, the information explosion brought fast communication of more information with lesser interest.

Washington intelligence became an all-source glut: millions of words daily from foreign radio broadcasts, thousands of embassy and attaché reports, a stream of communications intercepts, cartons of photographs, miles of recorded electronic transmissions—and a handful of agent reports. More and more, intelligence collection became devoted to current intelligence, to the minutiae of history that fill the daily and weekly bulletins to keep the policy-makers informed.

The AIS has not been immune to the pressures for such day-to-day coverage. More and more of its assets have been devoted to reporting from behind the scenes on current events, and a great deal of its effort has been expended on the coverage of internal affairs in countries of the most marginal importance to the U.S. interest. As the Service became more factual, and monthly production the yardstick of accomplishment, it has naturally devoted less time to the strategic operations that normally take years to develop.

III

Counterespionage operations are the hard core and essential resource of any intelligence service, for their primary purpose is to assist in guarding the nation's diplomatic and military secrets, including its own intelligence operations.

In 1946 AIS knowledge of the wartime Soviet intelligence services was confined to a scattering of names and operations culled from captured German and Japanese documents, a brief British organizational study, and a handful of wartime domestic spy cases. The counterespionage files were rapidly filled in the next ten years with the names of tens of thousands of Soviet "agents" that poured in from emigrés, intelligence mills, friendly security services, and AIS contacts. Anyone a "source" did not like became a Soviet agent: Soviet officials, Communist party members, hostile emigré leaders, leftist politicians, liberal journalists and labor leaders, etc. Most of this reporting was trash and treated as such.

During the 1950s hard information on the Soviet services and their operations was gradually built up from direct surveillance, arrested agents, intelligence defectors, and double-agent operations. Defectors were the richest source, and in the early sixties served not only to provide detailed information on Soviet intelligence personnel both at home and abroad and on the organization of the Soviet intelligence agencies and their methods of operation, but to identify hundreds of Soviet agents, mainly in Europe, many in NATO, who were arrested or monitored for further leads. The impressive list of exposures of Soviet penetrations of European intelligence services in the 1960s is directly traceable to leads, sometimes explicit, often vague, from both Polish and Soviet intelligence defectors.

The main counterespionage purpose of the AIS, however, is to detect and neutralize Soviet operations directed against strategic U.S. targets. Soviet intelligence has made, and continues to make, a determined effort to plant or recruit agents in the policy levels of State and Defense, and in such intelligence organizations as the National Security Agency, the CIA and the FBI. Virtually all their

operations against American targets originate abroad (they recognize the security and psychological hazards of recruiting an American official at home), and it has been the task of the AIS to uncover overseas leads and transmit them to the FBI for follow-up once a recruited or potential agent returns to the States.

For some years now the KGB, the Soviet civilian service, has carried on a systematic program to recruit Americans attached to official installations abroad. It is mainly interested in younger personnel, both file clerks and secretaries with access to classified information (code clerks are, of course, top priority) and Marine guards who can be most useful in safe-opening operations or installing concealed microphones. Some two to three hundred cases of direct approach by a Soviet officer are reported each year. Upon occasion an American who is approached may be encouraged to continue the contract if he is agreeable.

To what extent the KGB has been successful in penetrating federal agencies is bound to be a matter of conjecture. Unfortunately, in counterespionage operations what one can be sure about, what one knows about, may be insignificant compared to what one doesn't know about: the parameters of ignorance are limitless. Only if the AIS should secure the cooperation of the American desk chief of the KGB in Moscow could we say with assurance that there is not a Soviet agent in X or Y installation in Washington.

If there is such an agent, it is most unlikely that he is being handled out of the Soviet Embassy in Washington. The principal operational resource of the Soviet services abroad is not their official residents under diplomatic cover, but the "illegals" who have been dispatched to the West in increasing numbers during the past 15 years. These illegals, normally well-trained Soviet citizens with false Western documents and a carefully build-up legendary past, live and act as normal citizens in their country of residence, and have their own separate communications with Moscow. They are almost impossible to uncover by the usual investigative methods. Unless they make a mistake, or give themselves up (as his assistant resident did to implicate Colonel Abel), they are as safe as any secret agent in an open democratic society can be. The search for illegals continues to be a frustrating priority for both the European and American services.

Meanwhile, the role of some Soviet intelligence officers under diplomatic cover ("legals") is changing. The highly touted percentages of intelligence officials in any overseas Soviet installation—50 percent, 60 percent, 70 percent—can no longer be equated with the volume of Soviet espionage or other clandestine activities. More and more, experienced KGB officials have been assigned in recent years to duties other than running spies and working secretly with student and labor leaders.

Soviet diplomatic requirements in political, economic, trade and propaganda matters have grown dramatically since Khrushchev's day, and have outstripped the capacity of the Soviet Foreign Office. Experienced KGB officers are now often assigned to work as diplomats devoted to making friends in the Soviet interest without breaking the law. They are now, both in New York and in the great cities of Europe, hard at work developing friendly contacts with persons of influence

across the spectrum of public and private elites: politicians of the Center and the Right as well as the Left, labor leaders of all political complexions, key editors and journalists of all hues, and prominent members of the business and banking communities.

These Soviet contacts can be loosely called agents, but not spies. They are "agents of influence," persons who can sway national decisions on truck-assembly plants, loan terms, or Siberian investment projects in the Soviet interest. The new Soviet "diplomats," knowledgeable, sophisticated, linguistically competent, are earning their keep far better than by running a handful of spies in military establishments that have few secrets left. The KGB has become for Washington a diplomatic service to compete with as well as an espionage service to counter.

The Soviet services remain a formidable adversary on the espionage front. Their overall investment in secret work abroad has not declined since the days of "capitalist encirclement," and even today their operational personnel, both legals and illegals, number at least five times those of the American and European services combined. Ironically, as more and more military, technical and industrial information in the Western world has become freely available to Moscow, Soviet recruitment efforts against American and European targets have increased.

IV

No chapter in the history of the CIA is as public or controversial as its covert action program. When, in 1948, spurred by the Communist takeover in Czechoslovakia and the Italian political crisis, the National Security Council gave the CIA the responsibility for "political, psychological, economic, and unconventional warfare operations," the straightforward espionage mission of the AIS was enormously broadened, if not distorted. Known within the Service as "the PP mission," and originally carried out by a separate operating component within the CIA (the Office of Policy Coordination), these action operations and the new personnel responsible for them were soon integrated into the espionage and counterespionage service. This merger had a significant and enduring effect on the conduct and public image of American secret operations.

The cold war rationale for the covert action mission was simple: help stop the Russians. With Soviet troops poised to overrun Western Europe and "international communism" threatening the "free world" in France and Italy, Greece, Iran, Vietnam and China, with the military establishment severely reduced and State's diplomatic initiative stalemated, the White House gave its own new "secret arm" the offensive mission to fight the Russians with their own weapons.

If the size of Soviet intelligence operations can be estimated as roughly five times the size of their Western counterparts, the comparative scale of Soviet clandestine political operations has been even more disproportionate. The use for front organizations, an old Soviet staple, rose to new heights in the late Stalin period, and through them, as well as by direct subsidies to Communist parties and labor unions, the Soviets poured vast resources into the attempt to install Communist or friendly leftist governments in Europe, in Asia and in Latin America. An important adjunct was the use of wider prop-

aganda-type organization to sell the Soviet line and to denounce the West, especially the United States. The danger posed by these activities in the 1950s was not an illusion, and "covert action" became a popular expedient for taking American initiatives in the cold war without obvious official involvement. Presidents from Truman to Nixon were not reluctant to use it.

The secret offensive was three-pronged:

(1) To attack the enemy of his own terrain by supporting internal resistance movements (in the Ukraine, the Baltic States, Poland, and Albania); by supporting anti-Soviet or anti-Russian emigrés abroad, especially in Europe; by weakening the morale of the Soviet citizenry through propaganda delivered over the air (Radio Free Europe, Radio Liberty), by balloons, or through rumor campaigns.

(2) To contain, or roll back, "communism" in the "free world" by subverting Communist, crypto-Communist, or radical leftist governments (the labels were attached by the National Security Council) in Iran, in Guatemala, and, finally, in Cuba; by supporting non-Communist governments threatened by Communists in the Third World, culminating in Laos and South Vietnam; and by supporting "democratic" parties, labor unions, and intellectuals mainly in Europe during the shaky 1950s, and in Latin America during the 1960s. The case of Chile exemplifies the full range of political action operations from all-out support of a "friendly" Frei government to covert, as well as overt, actions designed to weaken an "unfriendly" Allende regime.

(3) To counter Soviet propaganda and international Communist fronts on the global scene by founding and funding publications, supporting anti-Communist editors and journalists, and orchestrating international propaganda campaigns; by building up "democratic" front organizations to counter the Communist fronts among students, youth, teachers, labor, etc.; by subsidizing American student and labor organizations to fight the Communist fronts abroad; by penetrating and upstaging Communist-organized World Peace meetings, youth rallies, and assemblies.

This broad assortment of propaganda, political and paramilitary operations was assigned to the secret intelligence service in order to hide their official sponsorship. The operations themselves, of course, from radios to invasions, were public events. The task was to cut the line from sponsor to actor, or at least to obscure it enough to place Washington in a position to deny official participation with a straight face.

("Plausible denial" was an oft-used phrase in the 1950s, and much ingenuity went into the planning of cover-stories or alternate explanations for proposed operations. Yet it was, even then, a hollow phrase, for it was impossible to deny operations that were exposed. In some, mainly large-scale paramilitary operations (the Guatemalan and Cuban invasions), denial was incredible. In others (the funding of Radio Free Europe), denial was implausible or pointless. Still others (support of the National Student Association) were undeniable when blown by participants. It is difficult to say in each case for whose benefit the operations were to be denied. The Russians? Our allies? The American public? World opinion?

It is simple enough to say now that what was worth doing in the 1950s (and early 1960s) should have been done openly—we could

have invaded Cuba as we did the Dominican Republic, subsidized anti-Communist radios and publications openly as we do now, and so on. Yet the arguments against such a course at the time were not trivial or without merit. With the Soviets managing to conceal their hand on many occasions, a public American response would have led to the application, to America's grave disadvantage, of the double standard that many in the world have all along been inclined to apply to Soviet and American actions. And, for a time, the anti-Communist sentiment of the Congress and public was so indiscriminating that would have been impossible to conduct, under the open eye of both, the kind of reasonably sophisticated operations needed to appeal to important forces abroad that would not accept the full range of American views or practices, yet were determined to resist being taken over by Communist forces.

As the years passed, these initial reasons largely lost their force, and it was a cardinal mistake not to have reacted to the change in circumstances before exposure finally forced the government's hand in the mid-sixties. Thus, the NSC assignment of the charter for covert action operations to the CIA has served to bring both the AIS and the CIA as a whole into the public disrepute it now enjoys. There is little point in arguing whether the White House was right or wrong in using the CIA as the "third leg" of our foreign policy mechanism. The cold war Presidents who allowed the Departments of State and Defense to shunt distasteful operations off on the "secret arm"—and the CIA Directors who, eagerly or reluctantly, accepted these incompatible tasks—felt the stakes requiring action were high. As time went by, however, they ignored not only the need for change but the drastic impact of lumping "noisy" action missions with secret intelligence operations. What was always an uneasy pairing became in time a self-defeating amalgam of disparate missions, and the damage not only to the reputation of the CIA but to the conduct of secret intelligence became progressively more serious.

V

In assessing the present and future state of the AIS, its action responsibilities provide the crucial matter for debate and decision. Covert action operations have declined steadily since the early 1960s outside of Indochina. Under Presidents Kennedy and Johnson, the use of covert methods to support particular candidates for office, or aspirants for power, in nations abroad became the rare exception, and today the practice has virtually died out—so that the ratio of charge to reality, in this area at least, is now extremely high. Yet the CIA charter remains in force and AIS action capabilities still exist. It is covert action psychological, paramilitary and political—that raises not only pragmatic but political and moral issues.

Psychological warfare operations not only do not belong in a secret service, but they are an anachronism in today's world. They should be discontinued.

Paramilitary operations pose a more serious question. That the United States must keep a paramilitary capability in being for wartime use will probably not be questioned by most observers. What has

become clear, however, is that a secret intelligence service is not the most suitable vehicle for running paramilitary operations. With the special privileges granted it by Congress, the CIA has been able to develop a highly efficient logistics machinery for moving personnel, equipment and funds rapidly and secretly around the world. It has therefore been called upon to carry out even large-scale paramilitary programs that would more logically fall to the Department of Defense.

There is little reason why the paramilitary charter should not be transferred to Defense, where all three services have appropriate specialized personnel, equipment and training facilities in being. All that is needed to make Defense effective in covert operations is to convert a small section of its command structure into a special operating unit which can be given congressional authority to move funds, personnel and equipment outside the bureaucratic system. This reassignment of responsibility would also bring future paramilitary operations under established congressional oversight and review.

If the AIS were to be stripped of its psychological and paramilitary operations, it could again become a truly secret service even if it retained a modified responsibility for political action.

Here, in the sphere of secret political action, the moral-political question appears to outweigh the pragmatic. How far should one nation interfere in the internal affairs of another nation?

In practice every major nation interferes daily in the affairs of other nations: by military and economic aid (or its denial), diplomatic arguments, short-wave broadcasts, fellowships and travel grants, etc. In short, Washington, like Moscow, is in this broad sense interfering all over the world all the time.

The more realistic way to phrase the issue is perhaps: to interfere *secretly*. And here no clear line can be drawn, for much of our official interference is secret: for example, the Ambassador's or military attaché's private conversation with a local politician, labor leader, or general. Perhaps the issue should be even more narrowly phrased: to interfere with *money*. Yet money is involved in many acceptable forms of international dealings—travel grants, say, or American fellowships. Perhaps the issue finally becomes: to interfere with *secret money*. Put in its most loaded form: should Washington bribe a foreign politician or labor leader to act in the American interest?

Here the line between "right" and "wrong" becomes cloudy indeed. When do private understandings with a chief of state become sinister? When does the passage of money or air tickets become bribery? It is at this level that the moral issue has to be settled if it ever will be—for noninterference is one of the vaguer terms in the vocabulary of co-existence.

It was proposed in a recent issue of this journal that the government "should abandon publicly all covert operations designed to influence political results in foreign countries" and restore the American Service to its original intelligence mission.² I would assent to this proposition with one exception and with one caveat.

The caveat first. If the President announces publicly that the CIA will no longer carry out secret political operations, no one will be

² Nicholas deB. Katzenbach, "Foreign Policy, Public Opinion and Secrecy," *Foreign Affairs*, October 1978.

lieve him—not the Russians, not our friends and foes around the globe, not the American public or press. "CIA" has become as much a symbol of American imperialism abroad and of secret government at home as the KGB has become, with American assistance, the symbol of Soviet imperialism and domestic repression. It is far too useful a symbol for anyone to give up, and no one will. A public statement that the U.S. government has now returned to the path of pristine democratic practices would be a quixotic, if not a slightly humiliating, gesture.

The exception is more controversial. Propaganda and paramilitary operations do not belong in a secret service—even if they are worth doing—nor, under today's conditions, do secret operations designed to sway elections or to overturn governments. Yet the kind of clandestine contacts that are still required, simply to keep on top of complex and important situations, cannot on occasion avoid having political overtones. The justification is, as it has been, to combat what remains the very large political activity of the Soviets and their allies. Their large-scale support for political elements in many countries of the world often leaves opposing non-Communist political figures naked and without adequate support. For the United States to stay in close touch with such elements is an elementary precaution, and there will continue to be occasions when support of a few individuals for intelligence purposes cannot (and should not) be separated from a measure of support for their political ends. There is little reason to rob the President—or the local Ambassador—of the chance to provide confidential support to a politician or labor leader who cannot afford to accept American largesse publicly.

Nor can we avoid the occasional political implications of intelligence liaison relationships with the secret services of other countries, the great bulk of which are with friendly nations whose services are under proper democratic control. In some cases such liaison has been conducted with governments whose independence has seemed, as a matter of national policy, to outweigh their failure to live up to democratic norms. It is inevitable that on occasion such governments will turn, by our standards, very sour indeed, as in the case of the Greek colonels, and it is a regrettable fact that an intelligence liaison aimed at external targets can then place the United States in the position of being attacked for an unintended degree of support for the local government. The key point here, however, is that intelligence liaison, like military or economic aid, is part of overall national policy, and reflects that policy: it does not normally operate in a vacuum. Indeed, in a few cases this service-to-service relationship has become the sole channel of communication with Washington for a government that has cut off diplomatic relations.

Two fundamental questions face the AIS today: can it remain a professional service and can it become a truly secret service? Neither question can be isolated from a consideration of its structure and its mission.

Relatively modest and independent in its beginnings (as the Office of Special Operations), the AIS doubled, then tripled in size with the creation of a parallel action office (Policy Coordination) and in the overall post-Korean expansion. It went the way of the entire intelligence community: a large bureaucracy with large staffs, interminable coordination, and countless echelons of decision-making.

The lethargy and timidity normal to a civil service bureaucracy exact a particularly heavy cost in an intelligence service where taking chances based on personal judgment is its main business. A Service is as good as its agents, and its agents are as good as the competence and initiative of the case-officer on the spot. Faced with a hypercautious, if not anxious, headquarters, the case-officer soon learns not to take chances. He plays it safe by keeping the bread-and-butter agents he has and not invading dangerous new ground—like the local foreign office or security service. The Service suffers.

As the AIS grew in size, it also became more and more closely integrated into the large-scale civil service bureaucracy that is the Central Intelligence Agency. Relatively independent at its inception, with its own administrative support structure, the AIS gradually became dependent on the CIA for its logistics, staff recruitment and training, personnel and accounting procedures, etc. Its integration into the Agency was capped by the move of all CIA components into a single headquarters building in Langley, Virginia, a move strongly opposed by many senior AIS personnel on security grounds. This objection was overruled with the assurance that the larger overt Agency elements would provide useful cover for the secret operators. Too many people inevitably came to know more than they needed to know about agent sources as compartmentalization broke down in the togetherness of researchers, administrators, and operators.

These and other considerations have led some AIS officers over the years to raise the notion of a separate truly secret intelligence service. The aim is a small elite professional service devoted exclusively to recruiting high-level agents against carefully selected long-term strategic targets. There would be no pressures for current production, no wholesale reporting requirements, no leaks to analysts, journalists or Soviet officials, no bureaucracy to hold up recruitment, no vast intelligence community to "service." Its foreign operatives would live under private, mainly commercial cover, reporting by unofficial communications to a small head office in, say, New York, whose anonymous chief would be directly responsible to the Director of Central Intelligence in his capacity as the President's head of the intelligence community.

The present Operations Directorate of the CIA would remain the integral part of the intelligence community it has become. It cannot be extracted from its present structure—as, for example, it would be administratively simple to extract the Federal Bureau of Investigation from the Department of Justice. Nor should it be. Although the Operations Directorate would no longer be depended upon to provide agent coverage of strategic intelligence targets, it would continue to function abroad on a reduced scale and with a more innocuous mission: to maintain liaison with local security and intelligence services, to protect the Embassy from hostile penetration, to handle agent or defector walk-ins. It would also serve as a channel for confidential communications between the Ambassador and the President or between the host government and the State Department, and supply local support for other elements of the intelligence community, including the National Security Agency, the military services and the FBI. Wherever feasible, and with deference to the sensitivities of the local situation, the CIA station chief might be overtly accredited as the CIA rep-

representative. He would, in any event, act as the Ambassador's overall assistant for intelligence matters.

However quixotic on the surface, a small American secret service separate from the federal bureaucracy is not at all impractical—given the will in high places. The concept of such a service is not too far removed from the Soviet system of illegals: carefully selected personnel, hand-tailored communications, small-scale operations, select priority targets. It would remain professional and secret.

(The present Central Intelligence Agency, shorn of its strategic espionage mission, would not be affected in its structure or main functions. It would continue to carry out its overt and technical collection operations, to provide its extensive services of common concern to the entire intelligence community, and to do current and in-depth analysis and research. It would, above all, continue to focus on its main central function—to give the White House intelligence estimates on situations and trends abroad that are as objective as men can make them. Only an agency exclusively concerned with intelligence can avoid the intrusion of bias into honest judgments that comes from the pressure in the Departments of State or Defense to support a specific diplomatic tack or a larger military budget.)

This proposal would simplify the vexing issue of congressional oversight. With overt and unexceptionable covert activities more clearly separated from truly covert ones, the supervision of the CIA itself would be substantially freed of the fear of exposing those operations that almost all members of Congress agree should remain secret. Present committees could thus operate more effectively. The truly secret operations of the AIS might best be reviewed by an ad hoc group of the top majority and minority members of the key committees who would weigh the policy implications, not the operating details, of the secret program.

Setting up a separate espionage service is only one side, and the simpler side, of the problem. What would be its mission? What targets would it be directed to cover that would justify its cost?

Sensibly limiting information requirements could halve the size of the intelligence community devoted to collection. Only against a clear-cut yardstick of essential information can a congressional oversight group or a presidential advisory group measure the effectiveness of our intelligence effort. (With covert psychological warfare a relic of the past, with paramilitary operations (if any) handled by the Pentagon and subject to the usual congressional scrutiny, with secret political actions carried out only at the express direction of the National Security Council, there would remain only the espionage and counter-espionage operations of the new AIS for the Congress to "oversee." And here the task should be to test performance by the product: raw agent reports measured against the government's requirements.)

Requirements properly come from outside the intelligence community. Intelligence exists to serve the decision-makers, and agent reports (ideally) fill the gaps in other coverage. For a small strategic AIS to carry out operations of real value requires that the policy-makers project with some concreteness their foreign policy objectives well into the eighties. Only then can they articulate, by countries or categories of information, their priority intelligence targets. As the

simple confrontations of the cold war give way to the more complex alignments of today, as economic and fiscal questions replace military hardware as topics of major interest, the intelligence needs of the White House are bound to shift. Is the Tokyo-Moscow axis a top priority? Are the Swiss bankers—or the German industrialists—a more important target than the Chinese General Staff?

Who will answer these questions?

It is possible, in a sanguine moment, to see a select joint congressional committee sitting down with the National Security Council and talking about the problems America faces in the decades ahead. They should confer until they come up with a clear statement in simple English of our long-term national objectives and a concrete list of specific areas and countries vital to our nation's interest.

In an even more sanguine moment one can envisage a broader, more representative body sitting down every two or three years and examining the *performance* of our foreign affairs and intelligence activities abroad. Such a group, chaired by the Vice President and supported by the National Security Council's administrative machinery, would ideally include not only Congressmen, but security-cleared citizens from business, labor, the media, academia. Their report to the American people might add a welcome breath of fresh air to the stale words from Washington.

Any decisions on our purposes in this faltering world can come only from the top and not out of the bowels of our foreign affairs bureaucracies. And those decisions cannot come by two-year or four-year executive fiat. They should be reached with the widest possible participation. The new President with his close ties to Congress is the ideal man to broaden the base for executive decisions in foreign policy. He should take the initiative in inviting the Congress to share his "awesome" responsibility for foreign affairs—perhaps even go so far as to first invite a systematic national debate. He can raise the level of that debate by being more open with the public on now-classified intelligence available within the executive branch. There is much to be gained, and—properly screened—little to be lost by publishing some of our excellent satellite photographs, or select national estimates on strategic situations as they arise, or current intelligence reports on significant events abroad.

The system of American democracy need not be exhausted by its present institutions, nor should the citizen sit on his hands as the complex pressures of an industrial society force the cancerous growth of the executive. No President in the future should be allowed to say on his own that the Dominican Republic or Cuba or Vietnam is vital to the American interest.

Once set, and amended, long-term national objectives lead to strategic intelligence as well as diplomatic targets, to a clean-cut mission for the new AIS. It is likely that these targets may lie in Zurich and Tokyo as well as Moscow or Bucharest or Cairo and concern themselves as much with goods and currencies as with war and politics. It is even possible that the AIS might on occasion, like the KGB in the recent Soviet grain deal, pay for its own budget by saving the taxpayer money.

H. WHAT'S WRONG WITH THE CIA?

By Tom Braden

[From Saturday Review, Apr. 5, 1975]

We are gathered, four of us CIA division chiefs and deputies, in the office of our agency's director, an urbane and charming man. He is seated at his desk, puffing nervously on his pipe and asking us questions.

Allen W. Dulles is fretting on this morning in the early fifties, as, indeed, he has fretted most mornings. You can't be in the middle of building an enormous spy house, running agents into Russia and elsewhere, worrying about Joseph McCarthy, planning to overthrow a government in Guatemala, and helping to elect another in Italy, without fretting.

But on this particular morning, Dulles is due for an appearance before Sen. Richard B. Russell's Armed Services Committee, and the question he is pondering as he puffs on his pipe is whether to tell the senators what is making him fret. He has just spent a lot of money on buying an intelligence network, and the network has turned out to be worthless. In fact, it's a little worse than worthless. All that money, Dulles now suspects, went to the KGB.

Therefore, the questions are somber, and so are the answers. At last, Dulles rises. "Well," he says, "I guess I'll have to fudge the truth a little."

His eyes twinkle at the word *fudge*, then suddenly turn serious. He twists his slightly stooped shoulders into the old tweed topcoat and heads for the door. But he turns back. "I'll tell the truth to Dick [Russell]," he says. "I always do." Then the twinkle returns, and he adds, with a chuckle, "That is, if Dick wants to know."

The reason I recall the above scene in detail is that lately I have been asking myself what's wrong with the CIA. Two committees of Congress and one from the executive branch are asking the question, too. But they are asking out of a concern for national policy. I am asking for a different reason. I once worked for the CIA. I regard the time I spent there as worthwhile duty. I look back upon the men with whom I worked as able and honorable. So for me, the question "What's wrong with the CIA?" is both personal and poignant.

Old friends of mine have been caught in evasions or worse. People I worked with have violated the law. Men whose ability I respected have planned operations that ended in embarrassment or disaster. What's wrong with these people? What's wrong with the CIA?

Ask yourself a question often enough, and sometimes the mind will respond with a memory. The memory my mind reported back is that scene in Allen Dulles' office. It seemed, at first blush, a commonplace, inconsequential episode. But the more it fixed itself in my mind, the more it seemed to me that it helped to answer my question about what's wrong with the agency. Let me explain.

The first thing this scene reveals is the sheer power that Dulles and his agency had. Only a man with extraordinary power could make a mistake involving a great many of the taxpayers' dollars and not have to explain it. Allen Dulles had extraordinary power.

Power flowed to him and, through him, to the CIA, partly because his brother was Secretary of State, partly because his reputation as the master spy of World War II hung over him like a mysterious halo, partly because his senior partnership in the prestigious New York law firm of Sullivan and Cromwell impressed the small-town lawyers of Congress.

Moreover, events helped keep power flowing. The country was fighting a shooting war in Korea and a Cold War in Western Europe, and the CIA was sole authority on the plans and potential of the real enemy. To argue against the CIA was to argue against knowledge. Only Joseph McCarthy would run such a risk.

Indeed, McCarthy unwittingly added to the power of the CIA. He attacked the agency and when, in the showdown, Dulles won, his victory vastly increased the respectability of what people then called "the cause" of anti-communism. "Don't join the book burners," Eisenhower had said. That was the bad way to fight communism. The good way was the CIA.

Power was the first thing that went wrong with the CIA. There was too much of it, and it was too easy to bring to bear—on the State Department, on other government agencies, on the patriotic businessmen of New York, and on the foundations whose directorships they occupied. The agency's power overwhelmed the Congress, the press, and therefore the people.

I'm not saying that this power didn't help to win the Cold War, and I believe the Cold War was a good war to win. But the power enabled the CIA to continue Cold War operations 10 and 15 years after the Cold War was won. Under Allen Dulles the power was unquestioned, and after he left, the habit of not questioning remained.

I remember the time I walked over to the State Department to get formal approval for some CIA project involving a few hundred thousand dollars and a publication in Europe. The desk man at the State Department balked. Imagine. He balked—and at an operation designed to combat what I knew for certain was a similar Soviet operation. I was astonished. But I didn't argue. I knew what would happen. I would report to the director, who would get his brother on the phone: "Foster, one of your people seems to be a little less than cooperative." That is power.

The second thing that's wrong with the CIA is arrogance, and the scene I've mentioned above shows that, too. Allen Dulles's private joke about "fudging" was arrogant, and so was the suggestion that "Dick" might not *want* to know. An organization that does not have to answer for mistakes is certain to become arrogant.

It is not a cardinal sin, this fault, and sometimes it squints toward virtue. It might be argued, for example, that only arrogant men would insist on building the U-2 spy plane within a time frame which military experts said could not be met. Yet in the days before satellite surveillance, the U-2 spy plane was the most useful means of keeping the peace. It assured this country's leaders that Russia was not plan-

ning an attack. But if arrogance built the plane quickly, it also destroyed it. For surely it was arrogant to keep it flying through Soviet airspace after it was suspected that the Russians were literally zeroing in on overflying U-2s.

I wonder whether the arrogance of the CIA may not have been battlefield-related—a holdover from World War II machismo and derring-do. The leaders of the agency were, almost to a man, veterans of OSS, the CIA's wartime predecessor. Take, for example, the men whose faces I now recall, standing there in the director's office.

One had run a spy-and-operations network into Germany from German-occupied territory. Another had volunteered to parachute into Field Marshall Kesselring's headquarters grounds with terms for his surrender. A third had crash-landed in Norway and, having lost half his men, came up, nevertheless, blowing up bridges.

OSS men who became CIA men were unusual people who had volunteered to carry out unusual orders and to take unusual risks. Moreover, they were impressed, more than most soldiers can be impressed, with the absolute necessity for secrecy and the certain penalty that awaited the breach of it.

But they had another quality that set them apart. For some reason that psychologists could perhaps explain, a man who volunteers to go on an extremely dangerous mission, alone or with one or two helpers, is likely to be not only brave and resourceful but also somewhat vain. Relatively few men *volunteered* to jump into German or Japanese territory during World War II. Those who did volunteer were conscious that they were, in a word, "different."

Once these men had landed behind the lines, the difference took on outward symbols. They were alone, Americans in a country full of French or Greek or Italians or Chinese. Often they were treated with great respect. Sometimes, as mere lieutenants, they commanded thousands of men. At a word from them, American or British planes came over to drop supplies to these men. They earned the love and respect that conquered people felt for the great democracy called America. Inevitably, they began to think of themselves individually and collectively as representing the national honor.

Is it not possible that men who have learned to do everything in secrecy, who are accustomed to strange assignments, and who think of themselves as embodying their country, are peculiarly susceptible to imperial Presidencies such as those of Lyndon Johnson and Richard Nixon? Have they not in fact trained themselves to behave as a power elite?

To power and to arrogance add the mystique of the inside-outside syndrome. That scene in the director's office defines the problem. Dulles was leveling with his assistants, and they were leveling with him. An agent or a station chief or an official of the CIA who didn't level—who departed in the slightest degree from a faithful account of what he knew or what he had done—was a danger to operations and to lives. Such a man couldn't last a day in the CIA.

But truth was reserved for the inside. To the outsider, CIA men learned to lie, to lie consciously and deliberately without the slightest twinge of the guilt that most men feel when they tell a deliberate lie.

The inside-outside syndrome is unavoidable in a secret intelligence

agency. You bring a group of people together, bind them with an oath, test their loyalty periodically with machines, spy on them to make sure they're not meeting secretly with someone from the Czech Embassy, cushion them from the rest of the world with a false cover story, teach them to lie because lying is in the national interest, and they do not behave like other men.

They do not come home from work and answer truthfully the question, "What did you do today, darling?" When they chat with their neighbors, they lie about their jobs. In their compartmentalized, need-to-know jobs, it is perfectly excusable for one CIA man to lie to another if the other doesn't need to know.

Thus it was ritual for Allen Dulles to "fudge," and often he didn't have to. Senator Russell might say, "The chairman has conferred with the director about this question, which touches a very sensitive matter." The question would be withdrawn.

Another technique for dealing with an outsider was the truthful non-response. Consider the following exchange between Sen. Claiborne Pell (D., R.I.) and Richard Helms. (The exchange was concerned with spying on Americans, an illegal act under the terms of the law that created the CIA.)

Senator Pell (referring to spying on antiwar demonstrations): "But these all occurred within the continental shores of the United States and for that reason you had the justifiable reason to decline [to] move in there because the events were outside your ambit."

Mr. Helms: "Absolutely, and I have never been lacking in clarity in my mind since I have been director, that this is simply not acceptable not only to Congress but to the public of the United States."

No doubt that answer was truthful. No doubt Helms did think that domestic spying was not acceptable. But he was doing it, and he didn't say he wasn't.

Finally, of course, there is the direct lie. Here is another excerpt from 1973 testimony by Helms:

Senator Symington (D., Mo.): "Did you try, in the Central Intelligence Agency, to overthrow the government of Chile?"

Helms: "No, Sir."

Symington: "Did you have any money passed to the opponents of Allende?"

Helms: "No, Sir."

Helms was under oath. Therefore he must have considered his answer carefully. Obviously, he came to the insider's conclusion: that his duty to protect the inside outweighed his outsider's oath. Or to put it another way, the law of the inside comes first.

Allen Dulles once remarked that if necessary, he would lie to anybody about the CIA except the President. "I never had the slightest qualms about lying to an outsider," a CIA veteran remarked recently. "Why does an outsider need to know?"

So much for the lessons of memory. Power, arrogance, and the inside-outside syndrome are what's wrong with the CIA, and to some extent, the faults are occupational and even necessary tools for the job.

But the events of the Cold War and the coincidence of Allen Dulles' having such enormous discretionary powers enlarged occupational risks until they became faults, and the faults created a monstrosity.

Power built a vast bureaucracy and a ridiculous monument in Langley, Va. Arrogance fostered the belief that a few hundred exiles could land on a beach and hold off Castro's army.

The inside-outside syndrome withheld the truth from Adlai Stevenson so that he was forced to make a spectacle of himself on the floor of the United Nations by denying that the United States had anything to do with the invasion of Cuba. The same syndrome has made a sad and worried man of Richard Helms.

It's a shame what happened to the CIA. It could have consisted of a few hundred scholars to analyze intelligence, a few hundred spies in key positions, and a few hundred operators ready to carry out rare tasks of derring-do.

Instead, it became a gargantuan monster, owning property all over the world, running airplanes and newspapers and radio stations and banks and armies and navies, offering temptation to successive Secretaries of State, and giving at least one President a brilliant idea: Since the machinery for deceit existed, why not use it?

Richard Helms should have said no to Richard Nixon. But as a victim of the inside-outside syndrome, Helms could only ask Watergate's most plaintive question: "Who would have thought that it would someday be judged a crime to carry out the orders of the President of the United States?"

A shame—and a peculiarly American shame. For this is the only country in the world which doesn't recognize the fact that some things are better if they are small.

We'll need intelligence in the future. And once in a while, once in a great while, we may need covert action, too. But, at the moment, we have nothing. The revelations of Watergate and the investigations that have followed have done their work. The CIA's power is gone. Its arrogance has turned to fear. The inside-outside syndrome has been broken. Former agents write books naming other agents. Director William Colby goes to the Justice Department with evidence that his predecessor violated the law. The house that Allen Dulles built is divided and torn.

The end is not in sight. Various committees now investigating the agency will doubtless find error. They will recommend change, they will reshuffle, they will adjust. But they will leave the monster intact, and even if the monster never makes another mistake, never again overreaches itself—even, indeed, if like some other government agencies, it never does anything at all—it will, by existing, go right on creating and perpetuating the myths that always accompanied the presence of the monster.

We know the myths. They circulate throughout the land wherever there are bars and bowling alleys: that the CIA killed John Kennedy; that the CIA crippled George Wallace; that an unexplained airplane crash, a big gold heist, were all the work of the CIA.

These myths are ridiculous, but they will exist as long as the monster exists. The fact that millions believe the myths raises once again the old question which OSS men used to argue after the war: Can a free and open society engage in covert operations?

After nearly 30 years of trial, the evidence ought to be in. The evidence demonstrates, it seems to me, that a free and open society cannot

engage in covert operations—not, at any rate, in the kind of large, intricate covert operations of which the CIA has been capable.

I don't argue solely from the box score. But let's look at the box score. It reveals many famous failures. Too easily, they prove the point. Consider what the CIA deems its known successes: Does anybody remember Arbenz in Guatemala? What good was achieved by the overthrow of Arbenz? Would it really have made any difference to this country if we hadn't overthrown Arbenz?

And Allende? How much good did it do the American people to overthrow Allende? How much bad?

Was it essential—even granted the sticky question of succession—to keep those Greek colonels in power for so long?

We used to think that it was a great triumph that the CIA kept the Shah of Iran on his throne against the onslaught of Mossadegh. Are we grateful still?

The uprisings during the last phase of the Cold War, and those dead bodies in the streets of Poland, East Germany, and Hungary: to what avail?

But the box score does not tell the whole story. We paid a high price for that box score. Shame and embarrassment is a high price. Doubt, mistrust, and fear is a high price. The public myths are a high price, and so is the guilty knowledge that we own an establishment devoted to opposing the ideals we profess.

In our midst, we have maintained a secret instrument erected in contradiction to James Madison's injunction: "A popular government without the means to popular information is a farce or a tragedy, perhaps both."

As I say, the investigating committees will prop the monster up. I would suggest more radical action. I would shut it down. I would turn the overt intelligence function over to the State Department. Scholars and scientists and people who understand how the railroads run in Sri Lanka don't need to belong to the CIA in order to do their valuable work well.

I would turn the paratroopers over to the army. If, at some time, it become essential to our survival to mount a secret attack upon a foe, the army is capable of doing it, and, with some changes in command structure in order to bypass bureaucracy, the army could do it as swiftly and secretly as the CIA. Under the command structure of the Department of Defense, congressional oversight would be possible. Then, if the army got caught fielding a secret division in Laos, and if the American people did not want a secret division in Laos, the American people would know where to turn.

I would turn the psychological warriors and propagandists over to the Voice of America. Psychological warriors and propagandists probably never did belong in a secret agency.

And, last, I would choose a very few men to run spies and such covert operations as the passage of money to those in other lands who cannot afford to accept American support openly. But I would limit covert operations to passing money to "friendlyies."

I would house these spy masters and money-passers in some obscure tool shed, and I would forbid, by law, any of them from ever calling

himself "director." They would not work for the CIA. Because I would abolish the name CIA.

As their chief, the President should choose for a term of six years some civilian who has demonstrated staunchness of character and independence of mind. I would make him responsible to a joint committee of Congress, as well as to the President, and I would not permit him to serve more than one term.

Thus, we might get rid of power. Without power, arrogance would not be dangerous. Thus, too, we could prevent the inside-outside syndrome, so essential to secrecy, from making a mockery of representative government.

As for the house that Allen Dulles built at Langley, we might leave it standing empty, our only national monument to the value that democracy places upon the recognition and correction of a mistake.

I. RECOMMENDATIONS OF THE COMMISSION ON THE ORGANIZATION OF THE GOVERNMENT FOR THE CONDUCT OF FOREIGN POLICY (THE MURPHY COMMISSION) CONCERNING COVERT ACTION

Covert Action: A Special Problem. To this point we have addressed only the intelligence activities of the intelligence community. But, in addition to those endeavors, the community—specifically CIA—has also been responsible for another activity which poses special problems of oversight and control. This is covert action, activity abroad intended not to gather information but to influence events, an activity midway between diplomacy and war. It has taken many forms, from the financial support of friendly publications to the mounting of significant paramilitary efforts.

The Commission has considered whether covert action should any longer be authorized at all. It recognizes that there are many risks and dangers associated with covert action. Partly for these reasons the use of covert action in recent years has markedly declined.

But we must live in the world we find, not the world we might wish. Our adversaries deny themselves no forms of action which might advance their interests or undercut ours, as quite recent as well as past events demonstrate. In many parts of the world a prohibition on our use of covert action would put the U.S. and those who rely on it at a dangerous disadvantage. We conclude, therefore, that

covert action cannot be abandoned, but that it should be employed only where clearly essential to vital U.S. purposes and then only after a careful process of high level review.

The current process for approval of covert action involves the submission of proposals to the 40 Committee. The Committee approves or disapproves, and its chairman, the Assistant to the President for National Security Affairs, issues appropriate instructions. In recent years, however, as authorizations have decreased in number, the procedures of the Committee have become quite informal, and it has met infrequently.

We believe present practices are inadequate. The sensitivity and risks of covert action require appropriate review and consultation. The Committee therefore proposes that:

- Covert action should only be authorized after collective consideration of its benefits and risks by all available 40 Committee members, and that*
- Besides granting initial approvals, the 40 Committee should regularly review the continuing appropriations of activities still being pursued.*

In addition to requiring careful review within the executive branch, the Commission believes that covert action should be reported to the

Joint Committee of the Congress on National Security proposed in Chapter 14. We also believe that the current requirement of law that the President personally certify to the Congress the necessity for all covert actions (the Hughes Amendment to the Foreign Assistance Act of 1974, P.L. 93-559) is harmful in associating the head of State so formally with such activities. We propose, therefore, that:

P.L. 93-559 be amended to require reporting of covert actions to be proposed Joint Committee on National Security, and to omit any requirement for the personal certification of the President as to their necessity.



APPENDIX III.

SOVIET INTELLIGENCE COLLECTION AND OPERATIONS AGAINST THE UNITED STATES

A. INTRODUCTION

The U.S.S.R. conducts espionage and "active measures" or covert action operations on a large scale against its main enemy—the United States.¹ These activities are carried out in the U.S. and abroad by the Soviet intelligence and security services—the KGB and the GRU—and by the intelligence and security services of Soviet-influenced Eastern European countries, via their officers and agents in the United States and in other countries.

The main targets are U.S. Government officials, members of the business, scientific and political communities with access to the U.S. Government, and other influential entities such as youth, journalist and trade organizations.

According to the CIA, the United States is still the major target of the Soviet Union, Soviet intelligence and security services regard the greater degree of contact between the United States and the U.S.S.R. resulting from detente both as an increased counter-intelligence threat and as an opportunity for recruitment of more intelligence sources.

1. General Structure and Command

The intelligence and security structure of the Soviet Union today consists of two main elements. The first is the Committee of State Security—known in the U.S.S.R. and abroad by its initials—KGB. The second element is the lesser-known military intelligence organization—the Chief Directorate of Intelligence of the General Staff—whose initials are GRU. Both of these organizations operate on a world-wide basis. There is no Soviet embassy abroad which does not have its contingent of KGB officers, and it is doubtful whether there are more than one or two without GRU officers. Furthermore, the diplomatically-accredited personnel in Soviet Embassies are generally from 40 percent to 60 percent GRU and KGB officers. However, while there are many similarities between the operations of these two organizations overseas, there is one basic difference between them. The GRU engages only in foreign intelligence collection and has no domestic functions. The KGB, however, exists to safeguard national security. It interprets this mandate in the broadest sense, and therefore both its foreign activities and its domestic mission are multi-faceted.

The KGB and GRU are nominally controlled by the Soviet Government but are actually commanded by the Communist Party of the Soviet Union (CPSU). Officially, both intelligence services report to the Council of Ministers of the Soviet Government; the KGB reports

¹ The People's Republic of China is now almost as important a target to the Soviet Union as is the United States.

directly and the GRU through the General Staff of the Ministry of Defense. It appears that the role of the Council of Ministers in overseeing these organizations is limited to administrative control, while the actual control of operations is a Party function. Both organizations report indirectly and directly to the CPSU leadership through their respective chiefs: Iurii Vladimirovich Andropov, Chairman of the KGB; and Marshal Andrei Antonovich Grechko, Minister of Defense. Both are full voting members of the Politburo, the highest ruling body of the CPSU.

2. Budget

Accurate estimates of Soviet expenditures on intelligence are difficult to arrive at, because of rigid security and because of the peculiarities of Soviet accounting practices. The available evidence indicates that both the KGB and GRU receive high priority in the allocation of funds and other resources.

3. The Soviet Intelligence and Security Services—The KGB

As noted above, the KGB has both domestic and foreign functions. Abroad, the KGB is responsible for the collection of foreign intelligence; for the control of all official Soviet installations and personnel; for the penetration of all hostile intelligence and security services; and for conducting covert and "executive action" programs. However, it concentrates a far greater share of its attention on its internal functions, which include: uncovering espionage, subversion and dissidence; censorship of all international, and selected internal communications; investigating crimes against the state and presenting evidence for prosecution; protecting the borders of the country; providing physical protection for the leaders and important installations of the Party and state, and for visiting foreign dignitaries; disrupting and neutralizing the activity of hostile intelligence services and *émigré* organizations by aggressive counterintelligence operations; supervising the development and installation of secure communications systems, and providing maintenance and security for those systems.

The number of KGB personnel engaged in clandestine activity directed against foreign countries is estimated by the CIA at 10,000 while the counterintelligence and security components operating inside the Soviet Union are much larger. With the inclusion of a sizeable administrative and support apparatus, the total number of all-Union or national-level personnel has been estimated at a total of 410,000. Of this total, the Border Troops have been credited with over 175,000 employees; the Kremlin Guards and possibly other uniformed components, while not individually reported, may number over 65,000.

In addition to the 410,000 national-level personnel estimate, each Republic and autonomous region has its own KGB structure, and there are KGB offices, in every town of any size across the entire Soviet Union.

B. ORGANIZATION AND STRUCTURE

1. Executive Level

The Chairman of the KGB, Iurii Vladimirovich Andropov, is assisted at the executive level by several deputies and by a senior policy-

making board known as the "collegium." This body meets at least once a month to discuss KGB activities. Other officials such as various specialists and the chairmen of the Republic-level KGB organizations participate in collegium discussions when specific problems are discussed.

2. Chief Directorate Level

The KGB has a highly-complex organizational structure, but it is generally correct to say that the First Chief Directorate is concerned with foreign operations and that the Second Chief Directorate has primary responsibility for internal security and counterintelligence.

a. *The First Chief Directorate*—The First Chief Directorate of the KGB is organized on both geographical and functional lines. The geographic departments are numbered, and the First Department operates against the United States and Canada. Traditionally, the numerical designation "First" has been assigned to the department that operates against the "main enemy" of the U.S.S.R. The United States has been that enemy since World War II; but the People's Republic of China has since been elevated almost to this status by current attitudes if not by formal organization.

The Second Department is responsible for Latin America, including Mexico. The Third Department concentrates on the United Kingdom, Australia, New Zealand and Scandinavia; the Fourth Department on West Germany, Austria and Switzerland, and so on for the thirteen additional departments.

The functional or specialized components of the KGB First Chief Directorate concern themselves with particular nongeographical targets, types of operations and types of information on a world-wide basis. There are several important components in this category:

—*The Counterintelligence Directorate* works directly against foreign intelligence and security services.

—*The Scientific and Technical Directorate* runs clandestine operations to collect information on technological advances and analyzes their application to military and industrial uses.

—*Department "A"* (Covert Action and Deception) plans, coordinates and supports those activities which are known as "active measures"—a name which approximates "covert action." [This group was formerly called Department "D"—disinformation and received extensive publicity in the West in the 1960s under that name.]

—*Department "V"*, formerly known as the Thirteenth Department, conducts assassinations, abduction, and other types of "executive action." It is known to have carried out assassinations abroad. Currently, this Department is primarily concerned with contingency planning for sabotage and partisan warfare operations.

—*The Intelligence Liaison Department* maintains liaison with the state security or intelligence services of the East European Communist countries and of other pro-Soviet states. It serves as a channel for levying requirements on those services and for coordinating their activities. While in recent years increased efficiency and diplomatic considerations have led to variations in the degree of Soviet control of the East European intelligence and security services, the CIA considers the services of these countries to be an effective extension

of the KGB. The CIA also considers the Cuban intelligence service (the DGI) to be effectively controlled by the KGB.

b. *The Second Chief Directorate.*—The primary responsibility of this group is internal security and counterintelligence, including penetration, detection and frustration of externally and internally supported anti-Soviet activities. All Soviet citizens, all foreign embassies and consulates, and the growing number of foreigners who visit and live in the U.S.S.R. each year are under its purview.

The Second Chief Directorate is broken down into several functional departments, including:

—The American Department, which conducts all operational activity directed at the official representatives of the United States, Canadian and Latin American governments in the Soviet Union. Its mission is two-fold: first, to minimize associations between diplomats and the Soviet citizenry and to monitor contacts that do take place; second, to attempt recruitment of American officials. One department is responsible for identifying, investigating, questioning and maintaining records on all Soviet citizens in authorized and unauthorized contact with United States officials in the U.S.S.R., including any Soviet citizen who wants to visit the U.S. Embassy for any reason. Another section arranges controlled contacts for U.S. Embassy officers during trips outside Moscow.

—The Foreign Tourists Department controls and attempts recruitment of tourists who visit the U.S.S.R. through a large informant network within all tourist services, including hotels, restaurants, campsites, service stations, etc.

C. THE GRU

The GRU has a significantly smaller number of personnel in Moscow than the KGB since it has only one function—the collection of foreign strategic intelligence. Its headquarters is reported to have 2,000 officers.

The GRU Chief, General of the Army Petr Ivashutin, is assisted by several deputies, as is the Chief of the KGB. Also, like the KGB, the GRU has a collegium which examines current problems and proposed activities. The GRU is broken down into geographic components, although fewer than the KGB. Of the four geographical components, one is responsible for collection of strategic information about the United States, the United Kingdom and Latin America.

Of the GRU's functional components, two deserve mention. One directorate is responsible for signals intelligence (SIGINT) collection. The primary intercept targets of this directorate are the strategic air and ground forces of the United States, Western European countries, Japan, and the People's Republic of China. SIGINT units in the U.S.S.R., East European countries, and covert units in Soviet embassies and trade missions abroad intercept and analyze all types of electronic communications, including encrypted and clear-text official messages, and telephone calls.

Another functional directorate trains Africans, Arabs, Asians and Latin Americans in organizing underground nets and insurgent movements in their countries. The training is done at camps and bases in

the U.S.S.R., and this directorate works closely with the CPSU Central Committee which is responsible for selecting the individual students or political groups to be trained.

D. THE SCOPE AND METHODS OF ANTI-UNITED STATES OPERATIONS BY THE KGB AND GRU

KGB and GRU officers total approximately one-third of the 10,000 Soviets currently assigned to official Soviet installations abroad (excluding military and economic aid missions). Government control of all Soviet trade, business and media services provides an additional type of cover for KGB and GRU officers. Additionally, Soviet intelligence officers occupy many posts in the United Nations administrative structure and in the U.N.'s auxiliary organizations, such as the International Atomic Energy Agency and the International Telecommunications Union.

The number of Soviet intelligence and operations officers is a misleading indicator of the scope of Soviet operations. Many Soviet officers are responsible for many informants or assets who provide intelligence, or carry out operations for the KGB and GRU.

A main objective of Soviet intelligence officers both in the United States and in countries in which U.S. installations exist and U.S. citizens live, is recruitment of Americans as intelligence assets. A 1959 Soviet directive which was reaffirmed as recently as 1975 states that "great attention" should be given to the recruitment of U.S. agents who have "access to encrypted and other secret correspondence, such as code clerks, secretaries and typists."

Another objective is the recruitment and cultivation of "agents of influence," or agents who can influence political events or decisions.

Soviet intelligence also mounts technical operations against U.S. installations and personnel. Planting of microphones and installation of telephone "taps" is done on a massive scale in the U.S.S.R. and Soviet-oriented countries. The Soviets are more selective in the West but they do conduct such operations. The primary targets are the officers and residences of U.S. ambassadors, senior foreign service personnel, CIA officers, and defense attaches.

E. EASTERN EUROPEAN SECURITY AND INTELLIGENCE SERVICES

According to the CIA, counterparts of the KGB and GRU in Eastern European countries serve in varying degrees as extensions of Soviet anti-United States intelligence collection and covert action operations.

Of the eight Communist countries in Eastern Europe, five (Poland, Czechoslovakia, Hungary, Bulgaria, and the German Democratic Republic) adhere closely to the Soviet line and their intelligence and security services are strongly influenced and, to a large extent, controlled by the KGB and the GRU. Soviet intelligence advisors are permanently assigned to their headquarters and the advisors have total access to all information collected by these services as well as to their "sources and methods" data. The U.S.S.R. is able to impose collection requirements on these Eastern European services for information not

needed by the country itself. The CIA knows of operations against U.S. citizens and installations carried out by Eastern European intelligence services under Soviet guidance.

The other three Communist countries in Eastern Europe (Romania, Yugoslavia, and Albania) have attained varying degrees of independence from the U.S.S.R., as is reflected by the absence of any significant liaison relationship between their security services and the KGB and GRU.

All Eastern European intelligence services concentrate heavily on the American target at home and abroad, frequently under direct Soviet guidance. While these services, by American or Soviet standards, are not large, in aggregate the number of officers they have assigned abroad approaches that of the Soviet intelligence services and they thus represent a significant enhancement of the already formidable capabilities of the KGB and GRU. They continue to exercise tight political control within their borders.

ADDITIONAL VIEWS OF SENATOR FRANK CHURCH CONCERNING COVERT ACTION

I believe this committee has produced a remarkably thorough report on the difficult subject of covert action. However, it is my own personal view that the covert action capability of the U.S. intelligence community ought to be circumscribed more sharply than a majority of the full committee was willing to recommend. I include these additional remarks to explain my point of view.

We live in a dangerous world. Soviet submarines silently traverse the ocean floors carrying transcontinental missiles with the capacity to strike at our heartland. The nuclear arms race threatens to continue its deadly spiral toward Armageddon.

In this perilous setting, it is imperative for the United States to maintain a strong and effective intelligence service. On this proposition we can ill afford to be of two minds. We have no choice other than to gather, analyze, and assess—to the best of our abilities—vital information on the intent and prowess of foreign adversaries, present or potential.

Without an adequate intelligence-gathering apparatus we would be unable to gauge with confidence our defense requirements; unable to conduct an informed foreign policy; unable to control, through satellite surveillance, a runaway nuclear arms race. "The winds and waves are always on the side of the ablest navigators," wrote Gibbon. Those nations without a skillful intelligence service must navigate beneath a clouded sky.

While one may debate the quality of the Agency's performance, there has never been any question about the propriety and necessity of its involvement in the process of gathering and evaluating foreign intelligence. Nor have serious questions been raised about the means used to acquire such information, whether from the overt sources, technical devices, or by clandestine methods.

What has become controversial is quite unrelated to intelligence, but has to do, instead, with the so-called covert operations of the CIA, those secret efforts to manipulate events within foreign countries in ways presumed to serve the interests of the United States. Nowhere are such activities vouchsafed in the statutory language which created the Agency in 1947. "No indication was given in the statute that the CIA would become a vehicle for foreign political action or clandestine political warfare," notes Harry Howe Ransome, a scholar who has written widely and thought deeply about the problems of intelligence in modern society. Mr. Ransome concludes that "probably no other organization of the Federal Government has taken such liberties in interpreting its legally assigned functions as has the CIA."

The legal basis for this political action arm of the CIA is very much open to question. Certainly the legislative history of the 1947 Act fails to indicate that Congress anticipated the CIA would ever engage in covert political warfare abroad.

The CIA points to a catch-all phrase contained in the 1947 Act as a rationalization for its operational prerogatives. A clause in the statute permits the Agency "to perform such other functions and duties related to intelligence affecting the national security as the National Security Council may, from time to time, direct." These vague and seemingly innocuous words have been seized upon as the green light for the CIA intervention around the world.

Moreover, these interventions into the political affairs of foreign countries soon came to overshadow the Agency's original purpose of gathering and evaluating information. The United States came to adopt the methods and accept the value system of the "enemy." In the secret world of covert action, we threw off all restraints. Not content merely to discreetly subsidize foreign political parties, labor unions, and newspapers, the Central Intelligence Agency soon began to directly manipulate the internal politics of other countries. Spending many millions of dollars annually, the CIA filled its bag with dirty tricks—ranging from bribery and false propaganda to schemes to "alter the health" of unfriendly foreign leaders and undermine their regimes.

The United States must acquire a longer view of history. We need not be so frightened by each Russian intervention. We need not feel so compelled to react in kind to each Russian move. We have gained little, and lost a great deal by our past policy of compulsive interventionism. Above all, we have lost—or grievously impaired—the good name and reputation of the United States from which we once drew a unique capacity to exercise matchless moral leadership. Where once we were admired, now we are resented. Where once we were welcome, now we are tolerated, at best. In the eyes of millions of once friendly foreign people, the United States is today regarded with grave suspicion and distrust.

I must lay the blame, in large measure, to the fantasy that it lay within our power to control other countries through the covert manipulation of their affairs. It formed part of a greater illusion that entrapped and enthralled our Presidents—the illusion of American omnipotence.

Nevertheless, I do not draw the conclusion of those who now argue that all American covert operations must be banned in the future. I can conceive of a dire emergency when timely clandestine action on our part might avert a nuclear holocaust and save an entire civilization.

But for such extraordinary events, certainly we do not need a regiment of cloak-and-dagger men, earning their campaign ribbons—and, indeed, their promotions—by planning new exploits throughout the world. Theirs is a self-generating enterprise. Once the capability for covert activity is established, the pressures brought to bear on the President to use it are immense.

I, myself, believe that all covert activity unrelated to the gathering of essential intelligence should be severed entirely from the CIA. If some circumstance in the future should require a secret operation in a foreign land, let it be done under the direct aegis of the States Department.

And if the covert activity is not impelled by the imperative of survival, itself, then let it be directly connected with legitimate security interests of the United States in a way that conforms with our tradi-

tional belief in freedom. Then, if our hand were exposed, we could scorn the cynical doctrine of "plausible denial," and say openly, "Yes, we were there—and proud of it!"

We were there in Western Europe, helping to restore democratic governments in the aftermath of the Second World War. It was only after our faith gave way to fear that we began to act as a self-appointed sentinel of the status quo.

Then it was that all the dark arts of secret intervention—bribery, blackmail, abduction, assassination—were put to the service of reactionary and repressive regimes that can never, for long, escape or withstand the volcanic forces of change.

And the United States, as a result, became even more identified with the claims of the old order, instead of the aspirations of the new.

The remedy is clear. American foreign policy, must be made to conform once more to our historic ideals, the same fundamental belief in freedom and popular government that once made us a beacon of hope for the downtrodden and oppressed throughout the world.

FRANK CHURCH



ADDITIONAL VIEWS OF SENATORS WALTER F. MON- DALE, GARY HART, AND PHILIP HART

We fully support the analysis, findings, and recommendations of this Report. If implemented, the recommendations will go far toward providing our nation with an intelligence community that is more effective in protecting this country, more accountable to the American public, and more responsive to our Constitution and our laws. The key to effective implementation of these recommendations is a new intelligence oversight committee with legislative authority.

Committees of Congress have only two sources of power: control over the purse and public disclosure. The Select Committee had no authority of any kind over the purse strings of the intelligence community, only the power of disclosure. The preparation of this volume of the Final Report was a case study in the shortcomings of disclosure as the sole instrument of oversight. Our experience as a Committee graphically demonstrates why legislative authority—in particular the power to authorize appropriations—is essential if a new oversight committee is to handle classified intelligence matters securely and effectively.

In preparing the Report, the Select Committee bent over backwards to ensure that there were no intelligence sources, methods, or other classified material in the text. As a result, important portions of the Report have been excised or significantly abridged. In some cases the changes were clearly justified on security grounds. But in other cases, the CIA, in our view, used the classification stamp not for security, but to censor material that would be embarrassing, inconvenient, or likely to provoke an adverse public reaction to CIA activities.

Some of the so-called security objections of the CIA were so outlandish they were dismissed out of hand. The CIA wanted to delete reference to the Bay of Pigs as a paramilitary operation, they wanted to eliminate any reference to CIA activities in Laos, and they wanted the Committee to excise testimony given in public before the television cameras. But on other more complex issues, the Committee's necessary and proper concern for caution enabled the CIA to use the clearance process to alter the Report to the point where some of its most important implications are either lost, or obscured in vague language. We shall abide by the Committee's agreement on the facts which are to remain classified. We did what we had to do under the circumstances and the full texts are available to the Senate in classified form. Within those limits, however, we believe it is important to point out those areas in the Final Report which no longer fully reflect the work of the Committee.

For example:

—Because of editing for classification reasons, the italicized passages in the Findings and Recommendations obscure the

significant policy issues involved. The discussion of the role of U.S. academics in the CIA's clandestine activities has been so diluted that its scope and impact on the American academic institutions is no longer clear. The description of the CIA's clandestine activities within the United States, as well as the extent to which CIA uses its ostensibly overt Domestic Contact Division for such activities, has been modified to the point where the Committee's concern about the CIA's blurring of the line between overt and covert, foreign and domestic activities, has been lost.

—Important sections which deal with the problems of "cover" were eliminated. They made clear that for many years the CIA has known and been concerned about its poor cover abroad, and that the Agency's cover problems are not the result of recent congressional investigations of intelligence activities. The deletion of one important passage makes it impossible to explain why unwitting Senate collaboration may be necessary to make effective certain aspects of clandestine activities.

—The CIA insisted upon eliminating the actual name of the Vietnamese institute mentioned on page 454, thereby suppressing the extent to which the CIA was able to use that organization to manipulate public and congressional opinion in the United States to support the Viet Nam War.

—Although the Committee recommends a much higher standard for undertaking covert actions and a tighter control system, we are unable to report the facts from our in-depth covert action case studies in depth which paint a picture of the high political costs and generally meager benefits of covert programs. The final cost of these secret operations is the inability of the American people to debate and decide on the future scope of covert action in a fully informed way.

The fact that the Committee cannot present its complete case to the public on these specific policy issues illustrates the dilemma secrecy poses for our democratic system of checks and balances. If the Select Committee, after due consideration, decided to disclose more information on these issues by itself, the ensuing public debate might well focus on that disclosure rather than on the Committee's recommendations. If the Select Committee asked the full Senate to endorse such disclosure, we would be unfairly asking our colleagues to make judgments on matters unfamiliar to them and which are the Committee's responsibility.

In the field of intelligence, secrecy has eroded the system of checks and balances on which our Constitutional government rests. In our view, the only way this system can be restored is by creating a legislative intelligence oversight committee with the power to authorize appropriations. The experience of this Committee has been that such authority is crucial if the new committee is to be able to find out what the intelligence agencies are doing, and to take action to stop things when necessary without public disclosure. It is the only way to protect legitimate intelligence secrets, yet effectively represent the public and

the Congress in intelligence decisions affecting America's international reputation and basic values. A legislative oversight committee with the power to authorize appropriations for intelligence is essential if America is to govern its intelligence agencies with the system of checks and balances mandated by the Constitution.

PHILIP HART
WALTER F. MONDALE
GARY HART



**INTRODUCTION TO SEPARATE VIEWS OF SENATORS
JOHN G. TOWER, HOWARD H. BAKER, JR., AND BARRY
M. GOLDWATER**

Our mutual concern that certain remedial measures proposed by this Committee threaten to impose undue restrictions upon vital and legitimate intelligence functions prevents us, in varying degrees, from rendering an unqualified endorsement to this Committee's Findings and Recommendations in their entirety. We also perceive a need to emphasize areas of common agreement such as our unanimous endorsement of intelligence reforms heretofore outlined by the President.

Therefore, we have elected to articulate our common concerns and observations, as viewed from our individual perspectives, in separate views which follow.

JOHN TOWER, *Vice Chairman.*
HOWARD H. BAKER, JR.
BARRY M. GOLDWATER.

(571)



SEPARATE VIEWS OF SENATOR JOHN G. TOWER, VICE CHAIRMAN

When the Senate mandated this Committee to conduct an investigation and study of activities of our Nation's intelligence community, it recognized the need for congressional participation in decisions which impact virtually every aspect of American life. The gravamen of our charge was to examine the Nation's intelligence needs and the performance of agencies charged with intelligence responsibilities, and to make such assessments and recommendations as in our judgment are necessary to maintain the delicate balance between individual liberties and national security. I do not believe the Committee's reports and accompanying staff studies comply fully with the charge to maintain that balance. The Committee's recommendations make significant departures from an overriding lesson of the American experience—the right of American citizens to be free is inextricably bound to their right to be secure.

I do not question the existence of intelligence excesses—the abuses of power, both foreign and domestic, are well documented in the Committee's report.

Nor do I question the need for expanded legislative, executive, and judicial involvement in intelligence policy and practices—the “uncertainties as to the authority of United States intelligence and related agencies” were explicitly recognized by Senate Resolution 21.

Nevertheless, I question, and take exception to, the Committee's report to the extent that its recommendations are either unsupported by the factual record or unduly restrict attainment of valid intelligence objectives.

I believe that the 183 separate recommendations proposing new detailed statutes and reporting procedures not only exceed the number and scope of documented abuses, but represent over-reaction. If adopted in their totality, they would unnecessarily limit the effectiveness of the Nation's intelligence community.

In the area of foreign intelligence, the Committee was specifically mandated to prevent “. . . disclosure, outside the Select Committee, of any information which would adversely affect the intelligence activities . . . of the Federal Government.” In his separate view Senator Barry Goldwater clearly points up the damage to our efforts in Latin America occasioned by release of the “staff report” on covert action in Chile. I objected to releasing the Chile report and fully support Senator Goldwater's assessment of the adverse impact of this “ironic” and ill-advised disclosure.

Another unfortunate aspect of the Committee's foreign report is its response to incidents of lack of accountability and control by recommending the imposition of a layering of Executive Branch reviews at operational levels and needless bifurcation of the decisionmaking process. The President's reorganization which centralizes foreign in-

telligence operations and provides for constant review and oversight, is termed "ambiguous." Yet the Committee's recommended statutory changes would [in addition to duplication and multiplication of decisions], add little except to insure that the existing functions set up by the President's program were "explicitly empowered," "reaffirmed" or provided with "adequate staff." By concentration upon such details as which cabinet officer should chair the various review groups or speak for the President, the Committee's approach unnecessarily restricts Presidential discretion, without enhancing efficiency, control, or accountability. The President's reorganization is a thorough, comprehensive response to a long-standing problem. It should be supported, not pilloried with statutory amendments amounting to little more than alternative management techniques. It is far more appropriate for the Congress to place primary legislative emphasis on establishing a structure for Congressional Oversight which is compatible with the Executive reorganization while eliminating the present proliferation of committees and subcommittee's asserting jurisdiction over intelligence activities.

Another area in which I am unable to agree with the Committee's approach is covert action. It would be a mistake to attempt to require that the Congress receive prior notification of *all* covert activities. Senator Howard Baker repeatedly urged the Committee to adopt the more realistic approach of obligating the Executive to keep the Congress "fully and currently informed." I believe any attempt by the legislative branch to impose a strict prior notification requirement upon the Executive's foreign policy initiatives is neither feasible nor consistent with our constitutionally mandated separation of powers.

On the domestic front the Committee has documented flagrant abuses. Of particular concern were the political misuses of such agencies as the Federal Bureau of Investigation and the Internal Revenue Service. However, while thoroughly probing these reprehensible activities and recommending needed changes in accountability mechanisms, the Committee's "corrective" focus is almost exclusively on prohibitions or limitations of agency practices. I hope this approach to remedial action will not be read as broad criticism of the overall performance of the intelligence community or a minimization of the Committee's own finding that "... a fair assessment must place a major part of the blame upon the failures of senior executive officials and Congress." In fact, I am persuaded that the failure of high officials to investigate these abuses or to terminate them when they learned of them was almost as reprehensible as the abuses themselves.

A further objectionable aspect of the Committee's approach is the scope of the proposed limitations on the use of electronic surveillance and informants as investigative techniques. With respect to electronic surveillance of Americans suspected of intelligence activities inimical to the national interest, the Committee would limit authority for such probes to violations of specific criminal statutes. This proposal fails to address the real problem of utilizing electronic surveillance against myriad forms of espionage. A majority of the Committee recommended this narrow standard while acknowledging that existing statutes offer inadequate coverage of "modern forms of espionage." The Committee took no testimony on revision of the espionage laws and

simply proposed that another committee "explore the necessity for amendments." To prohibit electronic surveillance in these cases pending such revision is to sanction an unnecessary risk to the national security. In adopting this position the Committee not only ignores the fact that appellate courts in two federal circuits have upheld the Executives inherent authority to conduct such surveillance, but also fails to endorse the Attorney General's comprehensive proposal to remedy objection to current practices. The proposed safeguards, which include requirements for the Attorney General's certification of hostile foreign intelligence involvement and issuance of a judicial warrant as a condition precedent to electronic surveillance, represent a significant expansion of civil liberties protections. The proposal enjoys bi-partisan support in Congress and I join those members urging prompt enactment.

I am also opposed to the methods and means proposed by the Committee to regulate the use of informants. Informants have been in the past and will remain in the future a vital tool of law enforcement. To adopt the Committee's position and impose stringent, mechanical time limits on the use of informants—particularly regarding their use against terrorist or hostile foreign intelligence activities in the United States—would be to place our faith in standards which are not only illusory, but unworkable.

In its overly broad approach to eliminating intelligence abuses, the Committee report urges departure from the Congress' role as a partner in national security policy and comes dangerously close to being a blueprint for authorizing Congressional management of the day-to-day affairs of the intelligence community. Whether this management is attempted through prior notification or a shopping list of prohibitive statutes and regulations, it is a task for which the legislative branch of government is ill-suited. I believe the adverse impact which would be occasioned by enactment of all the Committee recommendations would be substantial.

Substantial segments of the Committee's work product will assist this Congress in proceeding with the task of insuring the conduct of necessary intelligence activities in a manner consistent with our obligation to safeguard the rights of American citizens. However, we must now step back from the klieg lights and abuse-dominated atmosphere, and balance our findings and recommendations with a recognition that our intelligence agencies and the men and women who serve therein have been and will always be essential to the existence of our nation. This Committee was asked to provide a constitutionally acceptable framework for Congress to assist in that mission. We were not mandated to render our intelligence systems so constrained as to be fit for employment only in an ideal world.

In addition to the above remarks I generally endorse the positions set forth in Senator Baker's individual views.

I specifically endorse:

His views stating the need for legislation making it a criminal offense to publish the name of a United States intelligence officer stationed abroad under cover.

His position that there must be a system of greater accountability by our intelligence operations to the United States Congress and the American people.

His concern that the Congress exercise caution to insure that a proper predicate exists before any recommendations for permanent reforms are enacted into law.

His view that there be careful study before endorsing the Committee's far reaching recommendations calling for an alteration of the intelligence community structure. I also support the individual views of Senator Goldwater.

Further, I specifically endorse:

His assessment that only a small segment of the American public has ever doubted the integrity of our Nation's intelligence agencies.

His opinion that an intelligence system, however secret, does not place undue strain on our nation's constitutional government.

His excellent statement concerning covert action as an essential tool of the President's foreign policy arsenal.

His opposition to the publication of an annual aggregate figure for United States intelligence and his reasons therefor.

His views and comments on the Committee's recommendations regarding the National Security Council and the Office of the President. Specifically, comments number 12, 13 and 14.

His views challenging the proposed limitation concerning the recruitment of foreigners by the Central Intelligence Agency.

His views and general comments concerning the right of every American, including academics, clergymen, businessmen and others, to cooperate with his government in its lawful pursuits.

For the reasons stated above, I regret that I am unable to sign the final report of the Select Committee to Study Governmental Operations With Respect to Intelligence Activities.

JOHN G. TOWER,
Vice Chairman.

INDIVIDUAL VIEWS OF SENATOR BARRY GOLDWATER

This final report of the Select Committee on Intelligence Activities must be read with care. Historically, the work of the Committee and its report are an outgrowth of a period in which disillusionment, dismay, and disaffection were all too prevalent in America.

Failure in Vietnam and the Watergate scandals were prime contributors to the foregoing and helped produce a feeling that the ship of state was rudderless.

Under these circumstances of confusion, the basic premises of our foreign policy came into question, with some taking refuge in isolationism as the only way out. Others reacted as though some demon needed to be exorcized and launched a kind of guerilla attack upon our foreign policy.

Pressure from the new isolationists and the demonologists forced a skittish Congress into asserting a greater influence over the conduct of our foreign policy.

The results were mostly bad:

- Two good allies, Greece and Turkey, were alienated.
- Jewish emigration from Russia was reduced.
- The hands of our President were tied in the day-to-day conduct of foreign policy.
- U.S. intelligence was demoralized and its effectiveness greatly diminished.
- Our allies came to seriously question America's reliability, if not our collective sanity.
- Our adversaries took comfort in watching us tear ourselves apart.

In the field of intelligence activities, the worst of it all occurred in the Senate on October 2, 1974 when the Hughes Amendment (ultimately the Hughes-Ryan Amendment) was included in the foreign aid bill. Under its provisions, six committees of the Congress are required to be informed of any covert action conducted abroad. This means that approximately 50 Senators and over 120 Congressmen may receive highly sensitive information on a covert action program. It also means that public disclosure is almost inevitable, as proved to be the case in Angola.

As the Soviet Union moved decisively in Africa, pushing its Cuban mercenaries in the vanguard, and as the word "détente" came more and more to be understood as a game played under rules favorable to Moscow, a new appraisal seemed to be arising among our fellow citizens:

The pendulum had swung too far and much damage was being done to the Nation's foreign policy and the organizations necessary to its conduct.

The foregoing was largely in the past tense, because it is my hope and belief that the period of self-criticism, if not self-flagellation, is coming

to an end. If not, our once proud and strong Nation is headed for very hard times.

COVERT ACTION IN CHILE—1963-1973

Throughout the "Foreign and Military Intelligence" section of the Committee's final report, there are references to covert action in Chile which are based on a staff report of the Committee entitled, "Covert Action in Chile—1963-1973." Because the report was a "staff report," Senators on the Committee were not entitled to submit opposing views. In my opinion, the staff report is a distortion of history and will not stand the test of time. The following is what I believe to be a fair representation of events in Chile from 1963 to 1973 and any U.S. involvement.

On December 4, 1973, the Senate Select Committee on Intelligence Activities held public hearings on covert action in Chile covering the years 1963 to 1973. In his opening statement, Chairman Church stated that, "The nature and extent of the American role in the overthrow of a democratically-elected Chilean government are matters for deep and continuing public concern."

The Chairman then introduced the staff director, who with other members of the staff, summarized a staff report entitled, "*Covert Action in Chile 1963-1973*." The staff conclusion was even more specific: "In the period 1970 through 1973, in order to prevent a Marxist leader from coming to power by democratic means, the U.S. worked through covert action to subvert democratic processes. . . . this interference in the internal affairs of another country served to weaken the party we sought to assist and created internal dissensions which, over time, led to the weakening and, for the present time at least, an end to constitutional government in Chile."

These assertions, and the Committee report on which they are based, are misleading because they make it appear that the United States was responsible for the downfall of a respectable and truly democratic government. The real character of Allende and his coalition was ignored by excluding both public statements of philosophy and intent as well as the public record of highly illegal actions while in office.

Omitting publicly available information (not to mention the exclusion of voluminous classified intelligence dealing with Chilean support of Soviet and Cuban international subversion) makes it difficult for the American public to understand why anti-Allende operations were undertaken by three successive U.S. administrations. Moreover, the report concludes that "fears, often badly exaggerated or distorted, appear to have activated officials in Washington."

Thus, *Covert Action in Chile 1963-1973* leaves the impression of U.S. bungling in Chilean affairs induced by a corrosive fear of communism and Marxism.

While there may have been some mistakes made in the conduct of our affairs in Chile, the threat of a communist dictatorship under Allende was very real. To set the record straight, here are facts that should be taken into account:

1. Salvador Allende and the Unidad Popular

An avowed Marxist-Leninist, Allende participated in the creation of the Chilean Socialist Party in 1938, the year he graduated from medical school. He was elected a Federal Deputy in 1937, and was

named Secretary-General of the Socialist Party in 1943. Since its inception, the Chilean Socialist Party has been an extreme interpreter of Marxist-Leninist dogma, espousing violent revolution for Chile and the rest of Latin America.

Castro's Cuba became the Socialist model, and many young Socialists were trained in Cuba in guerilla warfare as well as in political action. Allende personally headed the Chilean delegation to the 1966 Tricontinental Conference in Havana and was a key figure in the creation of the Cuban-sponsored Latin America Solidarity Organization called LASO—created specifically to foment guerilla warfare in Latin America. It was the guiding force for the "Che" Guevara Guerrilla adventure in Bolivia in 1967.

In January 1970, Allende was listed as a director of the Chilean Committee of Support for the Bolivian People and the National Liberation Army, known as ELN.

Meanwhile the stronger, but less violent, Chilean Communist Party had joined the Socialist Party in a coalition which backed Allende as its presidential candidate in four presidential elections (1952, 1958, 1964 and 1970.) Allende was an active member of many Communist front organizations, particularly the World Peace Council, of which he was Vice-President during his first visit to the USSR in 1954.

Intelligence gathered over a period of many years has provided what Ambassador Korry calls "certain knowledge that the Soviet Union and other Communist governments and organizations provided substantial sums for covert political action to the Communist Party, to the Socialist Party, and to Allende himself."

The significance of Allende's election as President of Chile was thus readily apparent or should have been. Allende affirmed publicly in his 1970 campaign, as he had in previous campaigns for the presidency, that his intention was to bring about an irreversible Marxist revolution in Chile. He viewed himself as the man who would do what Castro failed to do: destroy America's leadership in Latin America. Allende minced no pre-election words. Prior to his election, he stated flat out that the United States was to be treated as "public enemy number one" in the western hemisphere.

Allende's tactics centered on using constitutional tools to fashion a socialist revolution, but he never pretended to espouse traditional parliamentary democracy. A minority president who received only 36.5% of the popular vote, he declared three months after taking office:

I am the President of the Unidad Popular. I am not the President of all the Chileans.

He and Castro chose to follow different roads, but Allende's intentions were never really masked. To quote again from his 1970 presidential campaign:

Cuba in the Caribbean and a Socialist Chile in the Southern Cone will make the revolution in Latin America.

Was this empty campaign rhetoric?

Soon after the 1970 election, Allende met secretly with Latin American revolutionaries and pledged covert support to them. Ambassador Korry has written: "In 1970, as in 1968, we know beyond a shadow

of a reasonable doubt that an Allende government intended to use the processes and laws of what it called formal democracy to eliminate and replace it with what it called popular democracy. (From 1961 to 1970, the Embassy, like the majority of Congress, agreed that such a development would do serious harm to U.S. interests and influence-for-good in the world.)"

2. Efforts of the Allende Government to Destroy Democratic Institutions

Communist Party leaders were largely in charge of the economic program of the Allende government. The communists intended gradually to replace private enterprise by State enterprise, thus enabling the government to assume complete social and economic power.

The government, therefore, drew up a list of all Chilean corporations whose capital reserves exceeded \$500,000. These companies, representing 82% of the capital holdings of all companies incorporated in Chile, were earmarked for nationalization. Congress attempted to block this government program by passing legislation defining the economic areas subject to government ownership, but the government continued to take over Chilean firms, using methods which became progressively more illegal.

These methods ranged from expropriations (declared unconstitutional by the Chilean Supreme Court), to requisitions (many of which were declared illegal by the Chilean Office of the Comptroller General), to "decrees of insistence" (a rarely used judicial tool created to resolve differences of legal interpretations between the judiciary and the executive).

In agriculture, all farms exceeding 80 hectares of irrigated land were made subject to legal expropriation. These "legal" expropriations were supplemented by those of roving armed bands who took possession of agricultural properties by force without any intervention by the Chilean police.

Similarly, a series of economic pressures was exerted to silence the independent media, including coercion, bribery, the manipulation of government control over credit, imports and prices, and the incitement of strikes.

As an adjunct to economic pressures, the Allende government began to develop the concept of "popular power", creating parallel revolutionary organizations which duplicated the functions of existing legal organizations. For example, special communal commands, known as JAPS, were established to control the distribution of essential articles, mainly food. Government supplies were channeled through these new organizations rather than through established retail outlets. Of Soviet origin, the communal commands had the dual function of displacing "bourgeois" organizations and of training their members for armed revolution.

Prior to the Allende regime, Chile had a strong democratic tradition and a firm commitment to constitutional processes. Under the Allende regime, its institutions fought long and tenaciously to save themselves from destruction by legal, constitutional means. When the government violated Chilean law, protests were filed with the courts and "contraloria."¹

¹ (Comptroller-General of the Republic, who supervised the legality of the government's actions.)

When the courts and the Contraloria objected to these violations, however, the government either paid no heed to these decisions or overruled them through "decrees of insistence", which were themselves illegal.

The National Congress also tried to check these violations of the law by impeaching the ministers responsible for them, but Allende merely moved the ousted ministers from one post to another, thus thwarting the purpose of Congressional sanctions.

Finally, when all the protests of the Congress, the courts and the Contraloria had been repeatedly ignored, these bodies solemnly declared that the Aliende government had placed itself outside both the law and the Constitution. These declarations were made by the Supreme Court on May 26, 1973, by the Contraloria on July 2, 1973, and by the Chamber of Deputies on August 22, 1973. The full text of the Chamber of Deputies resolution, and that of a subsequent August 29, 1973 Report of the Bar Association are appended in full, because they record many of the abuses and illegalities of the Allende government and also illustrate the inability of true democratic institutions to co-exist with a Marxist government. The Chamber's declaration was, in fact, a notice to the armed forces that the legal and constitutional order of the country had broken down.

The military coup of September 11, 1973 was the tragic climax of a long process of political polarization, exacerbated by the worst economic crisis in Chile's history:

- Inflation exceeded 300% in 1973;
- the trade balance deficit in the same year exceeded \$450 million;
- the foreign debt increased 6%)% in three years.

As the economic situation deteriorated, strikes proliferated, crippling the country. It was not U.S. "interference," but rather a minority's attempt to impose doctrinaire Marxism on a democratic framework, which led to the establishment of the present military government.

3. Chile: a Base for Soviet and Cuban Subversion

Within the Allende government, the Communist Party was largely responsible for running the economic program, counting heavily on Soviet support. There were 1,300-odd Soviets in Chile as of March 1972. Soviet Bloc credits of some \$200 million had been extended. Moreover, the Soviets were dangling an offer of \$300 million to the Chilean military for the purchase of military equipment. The Soviets, however, left to the Cubans most of the revolutionary guidance and support provided to the Allende coalition.

Under Allende, Chile became the center for Cuban operations in the southern cone of Latin America. Juan Carretero Ibanez, alias "Ariel", former chief of the Cuban Liberation Directorate (LD) for Latin America (the Cuban intelligence and executive action agency) arrived in Chile in October 1970 just prior to Allende's inauguration. He was soon followed by Luis Fernandez Ona, a senior intelligence officer of the DGI who became Allende's son-in-law. Chile re-established diplomatic relations with Cuba and the Cuban Embassy rapidly reached a

strength of 54 (later nearly 100) officers. Cuban visitors to Chile averaged 100 per month.

Cuban support to the Chilean government was primarily in the security field. The Cubans trained and armed the Presidential security guard, and also helped to develop an intelligence organization which functioned independently of established government services. Chilean police were trained in repressive security tactics, such as setting up neighborhood informant systems. The Cubans also provided arms, funds, and guerrilla training to hundreds of members of the Socialist Party and other far leftist Chilean militia groups.

Dozens of crates of arms, mostly of Soviet and Czech origin, were found stored in Allende's Santiago home and mountain retreat after he was overthrown. These crates had been flown in as "gifts" by Cuban airlines.

The Cuban intelligence effort in Chile, concentrated on exporting revolution to other Latin American countries, primarily Bolivia but also Argentina, Brazil and Uruguay. Some ten to fifteen thousand foreign revolutionaries flocked into Chile, where the Cuban LD center conducted a thriving business. The Center had a unit for providing false documents and training, and its operatives met revolutionaries in exile and visitors from other countries to receive their reports, pass money, arrange travel to Cuba and direct their activities.

In November 1971 Bolivian exiles in Chile announced formation of the Anti-Imperialist Revolutionary Front, known as FRA, which included the ELN. Its mission was to replace the Banzer Government with a government of the "proletariat". A number of FRA leaders in Chile travelled to and from Cuba. A massing of FRA exiles on the Chilean border drew official protests from the Bolivian government in April 1972.

Chile also served as a support base for the Argentine terrorist organization FRT/ERP. (Subsequently the PRT/ERP was responsible for such actions as the abduction and shooting of a State Department official and for extracting ransom in excess of \$20,000,000 from U.S. firms in Argentina.)

4. Actions of Allende's Coalition Subsequent to the March 1973 Elections

Like the other Unidad Popular parties, the Communist Party, known as the PCCH, began almost immediately after Allende's election to arm and train its membership in paramilitary tactics. Prior to March 1973, however, the Communist Party publicly and privately advocated policies designed to lull the political opposition and military into believing that the government would not resort to flagrant violations of the Chilean constitution. The PCCH believed that time was on the side of the government, and that the political opposition would be effectively stifled by progressively increasing government control of the economy.

This posture changed with the March 1973 congressional elections, which showed that the Christian Democrats and other parties in the political opposition were gaining rather than losing ground. The Communists, realizing that force was the only way to guarantee the continuance of the Marxist government, then joined the Socialist Party in pressing Allende to take harsher measures against the opposition.

After the September 1, 1973 coup, the junta government charged that the Unidad Popular had been planning a terrorist action, which was known as "Plan Z" and called for the assassination of military and opposition leaders as part of a move to secure total control of the country. A reliable leftist military source, who was in Chile prior to and during the military rebellion, confirmed that the leftist forces had indeed planned a pre-emptive move against the military, to have taken place during the independence celebrations of September 17-18, 1973. The documents and large arms caches discovered by military authorities after the coup suggest that Plan Z may indeed have existed.

A complete and fair assessment of the U.S. role in Chile can only be made if the following are taken into account:

1. The character of the Allende regime as revealed by public statements and by the nature of the political parties from which he drew support;
2. Efforts of the Allende regime to manipulate and ultimately destroy constitutional democracy;
3. Soviet and Cuban use of Chile as a base for international subversion;
4. The possibility that the Marxists were planning a pre-emptive and bloody coup to seize power totally.

The Senate Select Committee Staff Report on Chile concludes that "fears, often badly exaggerated and distorted, appear to have activated officials in Washington." But even the National Intelligence Estimate cited as endorsing this conclusion was published on June 14, 1973 and was written before Allende's violations of civil liberties were intensified. In the months after the Estimate the country's democratic processes were reduced to chaos and provoked the solemn declarations by the Supreme Court, Comptroller-General and Chamber of Deputies mentioned earlier.

U.S. policy toward Chile from 1962 to 1970 was consistent in attempting to prevent the take-over of the Government of Chile by Allende and his totalitarian Communist and Socialist supporters. The actions of the Allende regime after 1970 proves the wisdom of that policy.

In Chile, the U.S. was acting within the broad mainstream of traditional U.S. policy in Latin America, which has been to resist encroachment by powers outside the Western Hemisphere. The USSR dealt with the Allende government (and with the Chilean Communist Party, before and after Allende's election) at the very highest level. For example, the Soviet Ambassador to Allende's Chile, Alexander Vasilievich Basov, was one of only three members of the Central Committee of the Communist Party to be stationed in non-Communist capitals. The other two being in Washington and Paris.

The Allende experiment in Chile was seen by the Soviets as a model for other strategic countries. It is worth noting that both the Soviets and the Cubans considered the overthrow of the Allende government in Chile as a disaster to their interests. In their comments on Chile, the Soviets emphasize that Chile proves the thesis that "socialist revolution" should never be attempted without political control of the military forces.

There can be honest differences of opinion about the wisdom of American policy toward Chile over the last decade. What is missing

in the Staff report is the acknowledgement of a viewpoint contrary to its own conception: that Washington opinionmakers were activated by badly exaggerated and distorted fears. History has proved that minority Communist and radical Marxist parties ultimately destroy the elements of democracy and diversity which enable them to gain power. Allende clearly stated his intent to bring about an *irreversible* Marxist revolution in Chile.

Had the facts presented here been made available to the reader of the Staff Report, that reader might have concluded that U.S. Government fears were not "exaggerated or distorted", and might have concluded that the U.S. was essentially correct in its Chilean policy. This policy, prior to 1970, was to prevent a convinced Marxist from taking power and after 1970 strove to support and sustain until the 1976 elections a democratic opposition to a government which, by 1973, was clearly operating outside the laws and Constitution of Chile.

The results of the disclosures of sensitive classified data which were made during open hearings and in the published report on Chile will not be evident for some time to come, but two recent developments may be of interest.

First, the conclusion to the Staff Report states that "it would be the final irony of a decade of covert action in Chile if that action destroyed the credibility of the Chilean Christian Democrats."

According to an official report received by this Government, "Ex-President Frei feels completely shattered as a result of the release of the Senate report . . . and has confided to friends that it has brought his political career to a close . . . The source commented that it is ironic that U.S. congressional distaste for the role of the U.S. Government against the Allende Government may have succeeded in destroying the only viable alternative to the present Chilean government."

Second, data taken from the Report are being used to give credibility to false allegations about the Agency. An example is the *Washington Post* article of January 16, 1976 by Walter Pincus entitled "CIA Funding Journalistic Network Abroad." After quoting data taken from the Chile Report, the author quotes "a former intelligence agent" as claiming that the CIA subsidized the Latin American news service LATIN in much the same manner as it gave money to "El Mercurio." The true fact is that the CIA never gave any help, financial or otherwise, to LATIN, but this false allegation has been tied in with facts published in the Staff Report in such a way as to make it appear to have the Senate stamp of approval.

As of this writing Angola has fallen into the hands of a revolutionary group backed by the Soviet Union. The winning element was thousands of Cuban soldiers supplied with Russian weaponry. In other words, the Soviet Union used Cuban soldiers in Angola much the same way as Hessians were employed by the British during our own Revolutionary War.

To the world, the Soviet Union is boasting of its victory and the defeat of the U.S.

There is an ironical, if not tragic, postlude to the report *Covert Action in Chile 1963-1973*. On December 17, 1975 Fidel Castro made

a speech which quoted several paragraphs of the Report. Here is Fidel Castro's accolade:

... We consider the revelation of the report a positive move by the Senate committee despite the opposition of the President of the United States, even when much information was omitted because of pressure from the CIA itself and from the President's office....

FOREIGN AND MILITARY FINDINGS AND RECOMMENDATIONS

Turning to the report entitled "Findings and Recommendations of the Committee: Foreign and Military," two general observations can be made:

1. Much of the supporting evidence or information for this section of the report is drawn from a series of staff studies which have not been considered by the full committee in their final form as of this writing. Moreover, the staff reports are wider in scope than the testimony taken by the full committee.

2. Recommendations for reorganization of the intelligence community are not backed up by sufficient testimony or analysis.

Below are some detailed comments on the report. They follow the heading given on the "Contents" page.

1. Historical Note

The Select Committee on Intelligence Activities spent nearly \$3 million and over 15 months investigating the intelligence community, and it had a peak staff of over 120 professionals, consultants, and clerical personnel. I believe these facts should be a matter of record, because no excuses can be made for the final report based on a lack of time, money, or personnel. In fact, the Senate was more than generous in providing repeated extensions of time and money to the Select Committee. The results speak for themselves.

The truth of the matter is that approximately 6 months was spent in a fruitless investigation into alleged assassination attempts. During the course of the investigation of assassination attempts, not one bona fide assassination ordered by the U.S. Government was discovered. What did emerge were attempts on the life of Fidel Castro during the early 60's when our relations with Cuba were very close to being a state of war. In any event, much time and effort was frittered away in this unproductive exercise.

A. INTRODUCTION AND GENERAL FINDINGS

Committee Report:

... Allegations of abuse, revelations in the press, and the results of the Committee's 15 month inquiry have underlined the necessity to restore confidence in the integrity of our Nation's intelligence agencies. . . . (See p. 423.)

Comment:

Only a small segment of American public opinion has ever had any doubts in the integrity of our Nation's intelligence agencies. In general, the American people fully support our intelligence services and recognize them as the Nation's front line of defense. Accordingly, the use of the word "restore" is misleading.

Committee Report:

. . . At the same time, the Committee finds that the operation of an extensive and necessarily secret intelligence system places severe strains on the nation's constitutional government. . . . (See p. 425.)

Comment:

It is not the operation of an intelligence system that strains our nation's constitutional government. Any strains that exist are the direct result of Presidential misuse, misunderstanding, or abuse of the nation's intelligence capabilities. It should be noted that the report correctly salutes the men and women of the intelligence community, and also correctly points out that the Soviet KGB and other hostile intelligence services conduct spying and covert operations—(not to mention assassinations).

Committee Report:

. . . The Committee finds that covert action operations have not been an exceptional instrument used only in rare instances when the vital interests of the United States have been at stake. On the contrary, presidents and administrations have made excessive, and at times self-defeating, use of covert action. In addition, covert action has become a routine program with a bureaucratic momentum of its own. The long-term impact, at home and abroad, of repeated disclosure of U.S. covert action never appears to have been assessed. The cumulative effect of covert actions has been increasingly costly to American interests and reputation. The Committee believes that covert action must be employed only in the most extraordinary circumstances.

Comment:

Covert action is intended to provide the President of the U.S. and the nation with a range of actions short of war to preserve the free world and to thwart the global ambitions of Communist imperialism. Covert operations can and should be used in circumstances which might not be described as "vital" but are nevertheless necessary to prevent a crisis from occurring. One of the purposes of covert action is to prevent the occurrence of "most extraordinary circumstances." Those who support the above-mentioned quotation are in effect saying: "Don't put out the fire while it is small; wait until it becomes a conflagration."

Committee Report:

. . . Although there is a question as to the extent to which the Constitution requires publication of intelligence expen-

ditures information, the Committee finds that the Constitution at least requires public disclosure and authorization of an annual aggregate figure for United States national intelligence activities. . . . (See p. 425.)

Comment:

Publication of an annual aggregate figure for U.S. intelligence may appear to be innocent especially because estimates, with varying degrees of accuracy, have appeared in the press. Whether or not the Constitution requires such a disclosure is open to question. Traditionally, nations have kept their intelligence budgets secret for at least two reasons: First, they did not want to officially acknowledge the fact of these activities. Second, the publication of a figure might give potential adversaries some indication of the magnitude of their intelligence efforts. Both of these arguments may be somewhat obsolete in a world where little, if anything, is considered private.

There is still another objection which I submit cannot be discounted: Disclosing an annual aggregate figure will inevitably lead to demands for a breakdown of that figure. If these demands cannot be resisted, ultimately we would hand our adversaries very important indicators concerning the magnitude and thrust of our intelligence activities. In addition, our allies would be inclined to view such a step as one more signal that America is unable to protect its secrets leading to a possible further erosion of cooperative intelligence efforts. In any event, this matter should be decided by a vote of the entire Senate.

D. THE NATIONAL SECURITY COUNCIL AND THE OFFICE OF THE
PRESIDENT

Committee Report:

. . . The Central Intelligence Agency, in broad terms, is not "out of control." . . . (See p. 27.)

Comment:

After having heard the CIA described as a "rogue elephant run rampant", it is gratifying that the Committee now finds the CIA is not "out of control."

Committee Report:

. . . 12. By statute, the Secretary of State should be designated as the principal administration spokesman to the Congress on the policy and purpose underlying covert action projects. . . . (See p. 430.)

Comment:

Making the Secretary of State the spokesman for covert action could place him in a diplomatically untenable position. What is meant by "the Congress" in this context? This recommendation is vague and if enacted into the statutes could overburden the Secretary of State, who has more than enough work to do.

Committee Report:

... 13. By statute, the Director of Central Intelligence should be required to fully inform the intelligence oversight committee(s) of the Congress of each covert action prior to its initiation. No funds should be expended on any covert action unless and until the President certifies and provides to the congressional intelligence oversight committee(s) the reasons that a covert action is required by extraordinary circumstances to deal with grave threats to the national security of the United States. The congressional intelligence oversight committee(s) should be kept fully and currently informed of all covert action projects, and the DCI should submit a semi-annual report on all such projects to the committee(s). (See p. 430.)

Comment:

As mentioned in the introduction, the operation of the Hughes-Ryan Amendment requires 6 committees to be informed of any covert action. This recommendation would merely add another layer to the cake in the absence of a repeal of the Hughes-Ryan Amendment. If the Congress could agree that only a joint committee on intelligence or preferably the House and Senate Armed Services Committees were to be informed, I might be able to support the concept of prior notification. Prior notification raises an important point that should be carefully considered by the Congress: Does the Congress intend to share responsibility with the President for covert actions? In other words, will the Congress be content to accept our successes as well as our failures as secrets?

Committee Report:

... 14. The Committee recommends that when the Senate establishes an intelligence oversight committee with authority to authorize the national intelligence budget, the Hughes-Ryan Amendment (22 U.S.C. Section 2422) should be amended so that the foregoing notifications and Presidential certifications to the Senate are provided only to that committee. . . . (See p. 431.)

Comment:

This recommendation presupposes that the House of Representatives would be willing to accept the creation of a Senate committee as a sufficient reason to repeal the Hughes-Ryan Amendment. In the absence of an agreement with the House on repeal, this recommendation is meaningless.

F. THE CENTRAL INTELLIGENCE AGENCY

Committee Report:

... The Committee also questions the recruiting, for foreign espionage purposes, of immigrants desiring American citizenship because it might be construed as coercive. . . . (See p. 430.)

Comment:

Why should any category of foreigner be excluded from recruitment by the CIA? Does the Committee have any valid reason why it "questions" that any such recruitments "might be construed as coercive?" I submit it doesn't. Finally, if the Committee believes that coercion should not be used in the handling of immigrants, then it should say so.

Committee Report:

... 27. The congressional intelligence oversight committee should consider whether:

—the Domestic Collection Service (overt collection operations) should be removed from the Directorate of Operations (the Clandestine Service), and returned to the Directorate of Intelligence;

—The CIA regulations should require that DCD's overt contacts be informed when they are to be used for operational support of clandestine activities;

—The CIA regulations should prohibit recruiting as agents immigrants who have applied for American citizenship. . . . (See p. 442.)

Comment:

Until 1973 the Domestic Contact Service was part of the Directorate of Intelligence. It was placed under the Directorate of Operations to enable the CIA to provide better support for the Foreign Resources Division. Because the Domestic Contact Service has contacts with leaders in all walks of life, it possesses a unique capability to open the door for the clandestine services. Requiring that the Domestic Contact Service inform overt contacts that they are to be used for operational support of clandestine activities violates the important rule of compartmentalization. As previously noted, there is no valid reason for excluding immigrants unless coercion is part of the process.

Committee Report:

... Some covert operations have passed retrospect public judgments, such as the support given Western European democratic parties facing strong communist opposition in the late 1940s and 1950s. Others have not. In the view of the Committee, the covert harassment of the democratically elected government of Salvador Allende in Chile did not command U.S. public approval. (See page 445.)

Comment:

Here as in other parts of the report the story of what happened in Chile under Salvador Allende is distorted. While the Allende regime may have been "democratically elected", it gradually evolved into an abusive left-wing dictatorship. (See the preceding part of these individual views entitled *Covert Action in Chile 1963-1973* as well as the comments of Senator James L. Buckley in the *Congressional Record* of February 26, 1976.)

Committee Report:

. . . 36. The Committee has already recommended, following its investigation of alleged assassination attempts directed at foreign leaders, a statute to forbid such activities. The Committee reaffirms its support for such a statute and further recommends prohibition by statute of the following covert activities:

- —All political assassinations.
 - Efforts to subvert democratic governments.
 - Support for police or other internal security forces which engage in the systematic violation of human rights. . . .
- (See p. 448.)

Comment:

Prohibiting "efforts to subvert democratic governments" is a vague phrase, because there is no standard set as to what constitutes "democratic" governments. It also raises the problem of what the U.S. may do when a democratic government is headed inexorably towards dictatorship of the right or the left, and that this process may lead to a government which is hostile to America. Here again, we are confronted with the problem of putting out a fire while it is small as opposed to waiting until it becomes a conflagration. In some instances it is necessary for U.S. intelligence services to cooperate with the internal security forces of nations where there is systematic violation of human rights. The purpose of such cooperation is to gain foreign intelligence on vital targets. In order to gain the cooperation of the internal security forces in these countries, support is sometimes a condition for cooperation. In a world where the number of authoritarian regimes far outnumbers the number of democratic governments, such a prohibition limits the flexibility of our intelligence services in defending America.

Committee Report:

. . . 39. By statute, any covert use by the U.S. Government of American citizens as combatants should be preceded by notification required for all covert actions. The statute should provide that within 60 days of such notification such use shall be terminated unless the Congress has specifically authorized such use. The Congress should be empowered to terminate such use at any time. . . . (See p. 449.)

Comment:

If such a statute is enacted, the intelligence services will have to place greater reliance on foreign mercenaries for covert action. While I have no objection to the use of foreigners for this purpose, Americans are much more likely to serve loyally and courageously.

Committee Report:

. . . 42. The Committee is concerned about the integrity of American academic institutions for clandestine purposes. Accordingly, the Committee recommends that the CIA amend its internal directives to require that—individual academics

used for operational purposes by the CIA, together with the President or equivalent official of the relevant academic institutions, be informed of the clandestine CIA relationship. (See page 456.)

Comment:

While I believe that any institution or organization has the right to take positions on domestic or foreign policy issues, I also believe each individual American has the right to cooperate with his government in its lawful pursuits. I submit this right should apply to academics, clergymen, businessmen, union members, newsmen, etc. The more groups we exclude from assisting the intelligence community, the poorer our intelligence will be. Surely, our values have been turned upside down, when cooperating with the CIA is viewed as unseemly or degrading.

Committee Report:

... 54. By statute, the CIA should be prohibited from causing, funding, or encouraging actions by liaison services which are forbidden to the CIA.

Furthermore, the fact that a particular project, action or activity of the CIA is carried out through or by a foreign liaison service should not relieve the Agency of its responsibilities for clearance within the Agency, within the executive branch, or with the Congress. . . . (See p. 459.)

Comment:

In order to gain foreign intelligence the CIA sometimes enters into liaison operations with foreign services who may engage in activities that would be unacceptable within the United States. Some of these services are creatures of governments whose policies both domestic and foreign are unpalatable to American public opinion. The problem with Recommendation 54 is the use of the word "funding." It may not always be possible for the CIA to fully determine how funds to foreign services have in fact been used.

Committee Report:

... 55. The intelligence oversight committee(s) of Congress should be kept fully informed of agreements negotiated with other governments through intelligence channels. . . . (See p. 459.)

Comment:

If this requirement comes into effect, foreign intelligence services are going to be reluctant to enter into liaison arrangements with the CIA. Public disclosure of CIA activities over the past few years has already had a chilling effect on liaison operations. Let's not compound the felony.

Committee Report:

... 64. By statute, the General Counsel should be nominated by the President and confirmed by the Senate. . . . (See p. 461.)

Comment:

It is contrary to precedent to have the General Counsels of agencies and bureaus nominated by the President and subject to Senate confirmation. The General Counsel of any agency should be the choice of its chief executive officer.

Committee Report:

. . . 68. B. The Director of the CIA should be appointed by the President and subject to confirmation by the United States Senate. Either the Director or Deputy Director should be a civilian. . . . (See p. 465.)

Comment:

Why should the Director or Deputy Director of the CIA be a civilian? First, this implies a lack of integrity or ability among our uniformed services. Second, the CIA was created to provide a civilian organization that, among other things, would offset any bias in the military intelligence services.

Committee Report:

. . . 69. By statute, a charter for the NSA should be established which, in addition to setting limitations on the operation of the Agency (see Domestic Subcommittee Recommendations), would provide that the Director of NSA would be nominated by the President and subject to confirmation by the Senate. The Director should serve at the pleasure of the President but for not more than ten years. Either the Director or Deputy Director should be a civilian. . . . (See p. 465.)

Comment:

I agree that a charter for the NSA is desirable. Because the NSA is a service organization under the Department of Defense, I fail to see why the Director should be nominated by the President and confirmed by the Senate. NSA has a large proportion of civilians, and I can see no valid reason for prohibiting one of them rising to Director or Deputy Director. Nevertheless, Recommendation 69 repeats the implied insult mentioned above in connection with the DIA.

L. THE DEPARTMENT OF STATE AND AMBASSADORS

Committee Report:

. . . 71. The National Security Council, the Department of State, and the Central Intelligence Agency should promptly issue instructions implementing Public Law 93-475 (22 U.S.C. 2680a). These instructions should make clear that Ambassadors are authorized recipients of sources and methods of information concerning all intelligence activities, including espionage and counterintelligence operations. Parallel instructions from other components of the intelligence community should be issued to their respective field organizations

and operatives. Copies of all these instructions should be made available to the intelligence oversight committee(s) of Congress. (See p. 468.)

72. In the exercise of their statutory responsibilities, Ambassadors should have the personal right, which may not be delegated, of access to the operational communications of the CIA's Clandestine Service in the country to which they are assigned. Any exceptions should have the approval of the President and be brought to the attention of the oversight committee. . . . (See p. 468.)

Comment:

As a general statement, I cannot take exception to the concept that Ambassadors should be privy to all of the activities within their missions. There may be instances where the Chief of Station believes that the identity of a particular intelligence source should not be made known to the Ambassador. Rather than giving the Ambassador the final say under these circumstances, I believe both the Ambassador and the Chief of Station should have the right to appeal to the Secretary of State and the DCI.

Recommendation 72 is closely related to Recommendation 71 in that it extends the Ambassador's authority over the CIA Chief of Station. Here again, I believe the general statement is correct but that provision should be made for exceptional cases as previously stated. I believe exceptions in some cases should be worked out between the Secretary of State and the DCI rather than having to be submitted directly to the President.

I have refused to sign the final report of the Select Committee on Intelligence Activities in the belief that it will cause severe embarrassment, if not grave harm, to the Nation's foreign policy. A lengthy report of this nature, produced under heavy deadline pressure, further increases the possibility of embarrassment and unintentional security violations. Finally, the majority report tends to blacken the reputation of agencies and persons who have served America well. Senate Resolution 21 that created the Select Committee held the promise of a calm and deliberate investigation. That promise was not fulfilled, and this is a report that probably should never have been written.

BARRY GOLDWATER.

SEPARATE VIEWS OF SENATOR HOWARD H. BAKER, JR.

At the close of the Senate Watergate Committee, I felt that there was a compelling need to conduct a thorough examination of our intelligence agencies, particularly the CIA and the FBI. Congress never had taken a close look at the structure or programs of either the CIA or the FBI, since their inception in 1947 and 1924, respectively.¹

Moreover, there never had been a congressional review of the intelligence community as a whole. Therefore, I felt strongly that this Committee's investigation was necessary. Its time had come. Like the Watergate investigation, however, for me it was not a pleasant assignment. I say that because our investigation uncovered many actions by agents of the FBI and of the CIA that I would previously have not thought possible (e.g., crude FBI letters to break up marriages or cause strife between Black groups and the CIA assassination plots) in our excellent intelligence and law enforcement institutions. Despite these unsavory actions, however, I do not view either the FBI or CIA as evil or even basically bad. Both agencies have a long and distinguished record of excellent service to our government. With the exception of the worst of the abuses, the agents involved truly believed they were acting in the best interest of the country. Nevertheless, the abuses uncovered can not be condoned and should have been investigated long ago.

I am hopeful, now that all these abuses have been fully aired to the American people through the Committee's Hearings and Report, that this investigation will have had a cathartic effect; that the FBI and CIA will now be able to grow rather than decline. Such growth with a healthy respect for the rule of law should be our goal; a goal which I am confident can be attained. It is important for the future of this country that the FBI and CIA not be cast as destroyers of our constitutional rights but rather as protectors of those rights. With the abuses behind us this can be accomplished.

LONG-TERM IMPROVEMENT OF INTELLIGENCE COMMUNITY

On balance, I think the Committee carried out its task responsibly and thoroughly. The Committee's report on both the Foreign and Domestic areas are the result of extensive study and deliberation, as well as bipartisan cooperation in its drafting. The Report identifies many of the problems in the intelligence field and contains positive suggestions for reform. I support many of the proposed reforms, while differing, at times, with the means we should adopt to attain those reforms. In all candor, however, one must recognize that an investigation such as this one, of necessity, will cause some short-term damage to our intelligence apparatus. A responsible inquiry, as this has been, will in the long run result in a stronger and more efficient intelligence community. As my colleague Senator Morgan recently noted at a Committee meeting, such short-term injury will be outweighed by long-term benefits gained from the re-structuring of the intelligence com-

¹ Upon the expiration of the Watergate Committee in September 1974, I had the privilege to cosponsor with Senator Welcker, S. 4019, which would have created a joint committee on Congress to oversee all intelligence activities.

munity with more efficient utilization of our intelligence resources. Former Director William Colby captured this sentiment recently in a New York Times article:

Intelligence has traditionally existed in a shadowy field outside the law. This year's excitement has made clear that the rule of law applies to all parts of the American Government, including intelligence. In fact, this will strengthen American intelligence. Its secrets will be understood to be necessary ones for the protection of our democracy in tomorrow's world, not covers for mistake or misdeed. The guidelines within which it should and should not operate will be clarified for those in intelligence and those concerned about it. Improved supervision will ensure that the intelligence agencies will remain within the new guidelines

The American people will understand and support their intelligence services and press their representatives to give intelligence and its officers better protection from irresponsible exposure and harassment. The costs of the past year were high, but they will be exceeded by the value of this strengthening of what was already the best intelligence services in the world.²

The Committee's investigation, as former Director Colby points out, has probed areas in which reforms are needed not to prevent abuses, but to better protect and strengthen the intelligence services. For example, it is now clear that legislation is needed to make it a criminal offense to publish the name of a United States intelligence officer stationed abroad.³ Moreover, the Committee's investigation convinced me that the State Department should revise its publication of lists from which intelligence officers overseas predictably and often easily can be identified.

Yet we have not been able, in a year's time, to examine carefully all facets of the United States' incredibly important and complex intelligence community.⁴ We have established that in some areas problems exist which need intensive long-term study. Often these most important and complex problems are not ones which lend themselves to quick or easy solutions. As Ambassador Helms noted in his testimony during the Committee's public hearings:

. . . I would certainly agree that in view of the statements made by all of you distinguished gentlemen, that some result from this has got to bring about a system of accountability that is going to be satisfactory to the U.S. Congress and to the American people.

² New York Times, Jan. 28, 1976.

³ I intend to propose an amendment to S. 400 to make it a criminal offense to publish the name of a United States intelligence officer who is operating in a cover capacity overseas.

⁴ For many months, the Committee thoroughly and exhaustively investigated the so-called "assassination plots" which culminated with the filing of our report on November 18, 1975. This investigation was vitally important in order to clear the air and set the record straight. And, it was instructive as to how "sensitive" operations are conducted within our intelligence structure. But, it necessarily shortened the time available to the Committee to investigate the intelligence community as a whole.

Now, exactly how you work out that accountability in a secret intelligence organization, I think, is obviously going to take a good deal of thought and a good deal of work and I do not have any easy ready answer to it because I assure you it is not an easy answer. In other words, there is no quick fix. (Hearings, Vol. I, 9/17/75, p. 124).

THOROUGH STUDY NECESSARY IN SEVERAL AREAS

The areas which concern me the most are those on which we as a Committee have been able to spend only a limited amount of time,⁵ i.e., espionage, counterintelligence, covert action, use of informants, and electronic surveillance. It is in these areas that I am concerned that the Committee be extremely careful to ensure that the proper thorough investigatory predicate exist before any permanent reform recommendations be enacted into law.

Our investigation, however, has provided a solid base of evidence from which a permanent oversight committee can and should launch a lengthy and thorough inquiry into the best way to achieve permanent restructuring in these particularly sensitive areas. It is my view that such a study is necessary before I am able to endorse some of the Committee's recommendations which suggest a far reaching alteration of the structure of some of the most important facets of our intelligence system.

Therefore, while I support many of the Committee's major recommendations, I find myself unable to agree with all the Committee's findings and recommendations in both the foreign and domestic areas. Nor am I able to endorse every inference, suggestion, or nuance contained in the findings and supporting individual reports which together total in the thousands of pages. I do, however, fully support all of the factual revelations which our report contains concerning the many abuses in the intelligence field. It is important to disclose to the American people all of the instances of wrongdoing we discovered. With such full disclosure, it is my hope that we can turn the corner and devote our attention in the future to improving our intelligence gathering capability. We must have reform, but we must accomplish it by improving, not limiting, our intelligence productivity. I am confident this can be done.

CUMULATIVE EFFECT OF RECOMMENDATIONS

With regard to the totality of the Committee's recommendations, I am afraid that the cumulative effect of the numerous restrictions which the report proposes to place on our intelligence community may be damaging to our intelligence effort. I am troubled by the fact that some of the Committee's recommendations dip too deeply into many of the operational areas of our intelligence agencies. To do so, I am afraid, will cause practical problems: The totality of the proposals may decrease instead of increase our intelligence product. And, there

⁵ The Committee's mandate from Congress dictated that the abuses at home and abroad be given detailed attention. And, there are only a finite number of important problems which can be examined and answered conclusively in a year's time.

may be serious ramifications of some proposals which will, I fear, spawn problems which are as yet unknown. I am unconvinced that the uncertain world of intelligence can be regulated with the use of rigid or inflexible standards.

Specifically, I am not convinced that the answers to all our problems are found by establishing myriad Executive Branch boards, committees, and subcommittees to manage the day-to-day operations of the intelligence community. We must take care to avoid creating a Rube Goldberg maze of review procedures which might result in a bureaucratic morass which would further increase the burden on our already heavily overburdened tax dollar.

We should not over-reform in response to the abuses uncovered. This is not to say that we do not need new controls, because we do. But, it is to say that the controls we impose should be well reasoned and add to, not detract from the efficiency of our intelligence gathering system.

Increased Executive Branch controls are only one-half of the solution. Congress for too long has neglected its role in monitoring the intelligence community. That role should be significant but not all-encompassing. Congress has a great many powers which in the past it has not exercised. We must now do our share but, at the same time, we must be careful, in reacting to the abuses uncovered, that we not swing the pendulum back too far in the direction of Congress. Both wisdom and the constitutional doctrine of separation of powers dictate that Congress not place itself in the position of trying to manage and control the day-to-day business of the intelligence operations of the Executive Branch. Vigorous oversight is needed, but should be carefully structured in a new powerful oversight committee. I believe this can be achieved if we work together to attain it.

In moving toward improving our intelligence capability, we must also streamline it. It is in this approach that my thoughts are somewhat conceptually different from the approach the Committee is recommending. I am concerned that we not overreact to the past by creating a plethora of rigid "thou shalt not" statutes, which, while prohibiting the specific hypothetical abuse postured in the Report, cast a wide net which will catch and eliminate many valuable intelligence programs as well.

The Committee Report recommends the passage of a large number of new statutes to define the functions of and further regulate the intelligence community. I am troubled by how much detail should be used in spelling out the functions and limitations of our intelligence agencies for all the world to see. Do we want to outline for our adversaries just how far our intelligence agencies can go? Do we want to define publicly down to the last detail what they can and cannot do? I am not sure we do. I rather think the answer is found in establishing carefully structured charters for the intelligence agencies with accountability and responsibility in the Executive Branch and vigilant oversight within the Legislative Branch.

PRESIDENT'S PROGRAM

It is my view that we need to take both a moderate and efficient course in reforming our intelligence gathering system. In that regard, I think President Ford's recent restructuring of the intelligence community was an extraordinarily good response to the problems of the past. The President's program effected a massive reorganization of our entire intelligence community. It was a massive reaction to a massive problem which did not lend itself to easy solution. I am pleased that many of the Committee's recommendations for intelligence reform mirror the President's program in format. Centralizing the command and control of the intelligence community, as the President's program does, is the best way to ensure total accountability and yet not compromise our intelligence gathering capability.

Therefore, I endorse the basic framework of intelligence reform, outlined by President Ford, as embodying: (1) a single permanent oversight committee in Congress, with strong and aggressive staff, to oversee the intelligence community;⁶ (2) the Committee on Foreign Intelligence to manage the day-to-day operation of the intelligence community; (3) the re-constituted Operations Advisory Group to review and pass upon all significant covert actions projects;⁷ and (4) the Intelligence Oversight Board to monitor any possible abuses in the future, coordinating the activities and reports of what I am confident will be the considerably strengthened offices of General Counsel and Inspector General. This framework will accomplish the accountability and responsibility we seek in the intelligence community with both thoroughness and efficiency. Within this framework, Attorney General Levi's new guidelines in the Domestic Security area will drastically alter this previously sparsely supervised field. These guidelines will centralize responsibility for domestic intelligence within the Department of Justice and will preclude abuses such as COINTELPRO from ever reoccurring.⁸

SPECIFIC REFORMS

Within this basic framework, we must look to how we are going to devise a system that can both effectively oversee the intelligence community and yet not impose strictures which will eliminate its productivity. It is to this end that I suggest we move in the following direction:

⁶ My original support for a single joint committee of Congress has evolved, somewhat as affected by the events of this past year's House Intelligence Committee investigation, to support for a single Senate committee. However, I also favor the mandate of the new committee including, as does the present S. 400, a charge to consider the future option of merging into a permanent joint committee upon consultation with and action by the House of Representatives. The moment for meaningful reform is now and we must not lose it by waiting for a joint committee to be approved by both Houses of Congress.

⁷ I think a rule of reason should apply here. All significant projects certainly should receive careful attention from the Group. On the other hand, I would not require a formal meeting with a written record to authorize the payment of 2 sources in X country at \$50 per month to be changed to the payment of 3 sources in X country at \$40 per month.

⁸ I applaud the detailed guidelines issued by the Attorney General to reform the Department's entire domestic intelligence program. I think he is moving in the right direction by requiring the FBI to meet a specific and stringent standard for opening an intelligence investigation, i.e., the *Terry v. Ohio* standard.

(1) Demand responsibility and accountability from the Executive Branch by requiring all major policy decisions and all major intelligence action decisions be in writing, and therefore retrievable.*

(2) I recommend, as I have previously, that Congress enact a variation of S. 400, which I had the privilege to cosponsor. S. 400 is the Government Operations Committee bill which would create a permanent oversight committee to review the intelligence community. The existing Congressional oversight system has provided infrequent and ineffectual review. And, many of the abuses revealed might have been prevented had Congress been doing its job. The jurisdiction of the new committee should include both the CIA and the FBI, and the committee should be required to review and report periodically to the Senate on all aspects of the intelligence community's operations. In particular, I recommend that the Committee give specific careful attention to how we might improve as well as control our intelligence capability in the counterintelligence and espionage areas.

(3) Simultaneously with the creation of a permanent oversight committee, Congress should amend the Hughes-Ryan Amendment to the 1974 Foreign Assistance Act, § 662, which now requires the intelligence community to brief 6 committees of the Congress on each and every major intelligence action. Former Director Colby strikes a responsive chord when he complains that the present system will lead to leaking of vital intelligence information. We must put a stop to this. This can be done by allowing the intelligence community to report only to a single secure committee.

(4) Concomitantly with improved oversight, we in Congress must adopt stringent procedures to prevent leaks of intelligence information. In this regard, I recommend we create a regular remedy to prevent the extraordinary remedy of a single member of Congress disclosing the existence of a covert intelligence operation with which he does not agree. Such a remedy could take the form of an appeal procedure within the Congress so that a single member, not satisfied with a Committee's determination that a particular program is in the national interest, will be provided with an avenue of relief. This procedure, however, must be coupled with stringent penalties for any member of Congress who disregards it and discloses classified information anyway. I intend to offer an amendment to institute such a remedy when S. 400 reaches the Senate floor.¹⁰

(5) The positions of General Counsel and Inspector General in the intelligence agencies should be elevated in importance and given increased powers. I feel that it is extraordinarily important that these

* Never again should we be faced with the dilemma we faced in the assassination investigation. We climbed the ladder of authority only to reach a point where there were no more written rungs. Responsibility ceased; accountability ceased; and, in the end, we could not say whether some of the most drastic actions our intelligence community or certain components of it had ever taken against a foreign country or foreign leader were approved of or even known of by the President who was in office at the time.

¹⁰ I would favor a procedure, within the Congress, which would in effect create an avenue of appeal for a member dissatisfied with a Committee determination on a classification issue. Perhaps an appeal committee made up of the Majority and Minority leaders and other appointed members would be appropriate. Leaving the mechanics aside, however, I believe the concept is important and can be implemented.

positions, particularly that of General Counsel, be upgraded. For that reason, I think that it is a good idea to have the General Counsel, to both the FBI and the CIA, subject to Senate confirmation. This adds another check and balance which will result in an overall improvement of the system.¹² Additionally, I feel that it is equally important to provide both the General Counsel and Inspector General with unrestricted access to all raw files within their respective agencies.¹³ This was not always done in the past and will be a healthy addition to the intra-agency system of checks and balances.

(6) I am in favor of making public the aggregate figure for the budget of the entire intelligence community. I believe the people of the United States have the right to know that figure.¹⁴ The citizens of this country have a right to know how much of their money we are spending on intelligence production. But, they also want to get their money's worth out of that tax dollar. They do not want to spend their money for intelligence production which is going to be handicapped; which is going to produce poor or inaccurate intelligence. Therefore, I am opposed to any further specific delineation of the intelligence community budget. Specifically, I am opposed to the publication of the CIA's budget or the NSA's budget. It seems to me we are dealing with the world of the unknown in predicting what a foreign intelligence service can or cannot extrapolate from these budget figures. We received no testimony which guaranteed that, if Congress were to publish the budget figure for the CIA itself, a hostile intelligence organization could not extrapolate from that figure and determine much more accurately what the CIA capabilities are in any number of vital areas. Without such testimony, I am not prepared to go that far. The public's right to know must be balanced with the efficiency and integrity of our intelligence operations. I think we can accomplish both by taking the middle road; publishing the aggregate figure for the entire intelligence community. It is this proposal that I have voted in favor of.

There are a number of other specific findings and recommendations, supported by a majority of the Committee, which require additional brief comment.

¹² I differ with the Committee in that I would not have the General Counsel and Inspector General file reports and/or complaints concerning possible abuses with the Attorney General. Rather, I think the more appropriate interface in a new oversight system would be for both to take complaints to the Intelligence Oversight Board and the new congressional oversight committee. The Attorney General would remain the recipient of any and all complaints regarding possible violations of law.

¹³ I support the Committee's recommendation that agency employees report any irregularities directly to the Inspector General without going through the chain of command, i.e. through the particular division chief involved.

¹⁴ I do not feel that, despite my personal view that the aggregate budget figure should be disclosed to the public, only six to eleven members of the Senate have the right to release unilaterally the actual budget figures. A majority of both Houses of Congress should be necessary to release such information. And, while I would cast my vote in favor of the release of the aggregate budget figure, I am troubled that there may be no such vote. I am not sure the "right" result justifies the "wrong" procedures, because the next time the wrong procedure can just as easily be utilized to reach the wrong result.

FOREIGN INTELLIGENCE RECOMMENDATIONS

(1) COVERT ACTION

I believe the covert action capability of our intelligence community is vital to the United States. We must maintain our strength in this capacity, but, we must also control it. The key and difficult question, of course, is how we can control it without destroying or damaging its effectiveness. In my view, the best way to both maintain strength and yet insure accountability is to have strict control of the covert action programs through the Operations Advisory Group, with parallel control and supervision by the proposed permanent congressional oversight committee.

Covert action is a complex United States intelligence capability. Covert action provides the United States with the ability to react to changing situations. It is built up over a long period of time. Potential assets are painstakingly recruited all over the world. Having reviewed the history of covert action since its inception, I do not look upon the intelligence agents involved in covert action as a modern day group of bandits who travel the world murdering and kidnapping people. Rather, a vast majority of covert action programs are not only valuable but well thought approaches through media placement and agents of influence which produce positive results.

Covert action programs cannot be mounted instantly upon a crisis. It is naive to think that our intelligence community will be able to address a crisis without working years in advance to establish sources in the various countries in which a crisis might occur. These sources provide what is referred to as the "infrastructure," which must necessarily be in place throughout the world so that the United States can *predict* and *prevent* actions abroad which are inimical to our national interest.¹⁴ I believe that, were we to completely abolish covert action or attempt to remove it from the CIA and place it in a new separate agency, these sources would dry up; and, when a crisis did come, our intelligence community would not be able to meet it effectively. Not only do I question the effectiveness a new separate agency for covert action would have, but such a re-structuring would unnecessarily increase our already burgeoning bureaucracy.

I think that it is important to realize that covert action cannot be conducted in public. We cannot take a Gallup Poll to determine whether we should secretly aid the democratic forces in a particular country. I do not defend some of the covert action which has taken place in Chile. But, the fact remains that we cannot discuss publicly the many successes, both major and minor, which the United States has achieved through the careful use of covert action programs. Many individuals occupy positions of power in the world today as a direct result of aid given through a covert action program. Unfortunately, we cannot boast of or even mention these significant achievements. In short, we cannot approach covert action from a public relations point of view. We should not forget that we must deal with the world as it is today—with our adversaries employing their equivalent of covert

¹⁴ For example, testimony before the Committee established that the CIA's failure to act more positively in Portugal was a direct result of an absence of sufficient clandestine infrastructure. William E. Colby testimony, 10/28/75; William Nelson testimony, 11/7/75.

action. We must either say that the intelligence community should have the power to address world problems in this manner, under the strict control of the President and Congress, or we should take away that power completely. I cannot subscribe to the latter.

Finally, the issue remains as to how we can best control covert action through statutory reform. First, I believe the Executive Branch can and should carefully review each significant covert action proposal. This will be accomplished through the Operations Advisory Group under the program outlined by President Ford.

Second, Congress can control covert action by passing legislation requiring that the new oversight committee be kept "fully and currently informed." This, I believe, is the appropriate statutory language to apply to covert action. I do not agree with the Committee's recommendation that "prior notice" be given to Congress for each and every covert action project. As a matter of practice, the important and significant covert action programs will be discussed with the oversight committee in a form of partnership; and this is the way it should be. "Fully and currently informed" is language which has served us well in the atomic energy area. It has an already existing body of precedent that may be used as a guide for the future. It is flexible, like the Constitution, and provides a strong, broad base to work from. I am not prepared to say, however, that in the years ahead there may not be some vitally sensitive situation of which Congress and the oversight committee should not be told in advance. While the likelihood of this occurring is not great, we should never foreclose with rigid statutory language possibilities which cannot be foreseen today. Our statutory language must be flexible enough to encompass a variety of problems and potential problems, yet rigid enough to ensure total accountability. "Fully and currently informed" accomplishes both purposes.

(2) CIA PUBLISHING RESTRICTIONS

In the area of restrictions on the CIA's publishing of various materials, I am in complete agreement that anything published in the United States by the CIA, or even sponsored indirectly by the CIA through a proprietary, front, or any other means, must be identified as coming from the CIA. Publications overseas are another matter. We should allow the Agency the flexibility, as we have in our recommendations, to publish whatever they want to overseas and to publish under whatever subterfuge is necessary and thought advisable.¹⁶

DOMESTIC INTELLIGENCE RECOMMENDATIONS

While the Committee's Domestic Intelligence Report represents an excellent discussion of the problems attendant to that field of intelligence, I feel several of the recommendations may present practical problems. Although our objective of achieving domestic intelligence reforms is the same, I differ with the majority of the Committee in how best to approach the achievement of this goal.

¹⁶I do not view the "domestic fallout" as a real problem. To be sure, some publications by the CIA abroad will find their way back to the United States. However, to try to impose severe restrictions to prevent such fallout would cause unnecessary damage to the CIA's valid production of propaganda and other publications abroad.

(1) INVESTIGATIVE STANDARDS

Scope of Domestic Security Investigations

At the outset, I note that most of my concern with the standards for investigations in the domestic security area stem from the fact that "domestic security" is defined by the Committee to include both the "terrorism" and "espionage" areas of investigation. Severe limitations, proscribing the investigation of student groups, are more readily acceptable when they do not also apply to terrorist groups and foreign and domestic agents involved in espionage against the United States. To include these disparate elements within the same "domestic security" rubric, it seems to me, will create unnecessary problems when it comes to the practical application of the theoretical principles enunciated in the Committee's recommendations.

(a) *Preventive intelligence investigations*—The Committee's recommendations limit the FBI's permissible investigations in these critical areas of terrorism and espionage under standards for what the Committee delineates as preventive intelligence investigations. Under these standards the FBI can only investigate where:

it has a specific allegation or specific or substantiated information that (an) American or foreigner *will soon engage* in terrorist activity or hostile foreign intelligence activity [emphasis added].¹⁶

I am not convinced that this is the best way to approach the real problem of limiting domestic intelligence investigations. While in theoretical terms the standards of the recommendations may seem appropriate, I fear the inherent practical consequences of their application to the cold, real world of terrorism and espionage. The establishment of an imminency requirement by not permitting *any* investigation by the FBI unless the allegation or information received establishes that the person or group will "soon engage" in certain activity might prohibit any number of legitimate and necessary FBI investigations. For example, an allegation of an assassination attempt on a public figure at an unspecified date in the future could be precluded from investigation; or, vague information received by the FBI that there was a plan to obtain some nuclear components, but no indication of when or how, could also be prohibited from investigation. Surely, matters such as these should be the valid subjects of investigation—no matter how vague or piecemeal the information is.¹⁷

(b) *Time limits*—The Committee's recommendations would limit any preliminary FBI investigation of an allegation of wrongdoing in the Domestic Security area to 30 days from the receipt of the information, unless the Attorney General "finds"¹⁸ that the investigation need be extended for an additional 60 days. The FBI investigation may continue beyond 90 days only if the investigatory efforts establish "reasonable suspicion" that the person or group "will soon engage in"

¹⁶ Committee Domestic Report, p. 820.

¹⁷ My experience dictates that many investigations are begun with very limited or sketchy information. FBI agents and investigators in general are not always or even often immediately presented with information which constitutes probable cause of a crime. Probable cause is often established only through painstaking investigation: putting bits and pieces together. I think we must take this into consideration when formulating threshold investigatory standards.

¹⁸ It is unclear what standard is to be the predicate for any such finding.

terrorist or foreign espionage activities.¹⁹ And, even a full preventive intelligence investigation is not permitted to continue beyond "one year," except upon a finding by the Attorney General of "compelling circumstances."²⁰

While well-intentioned, I am not persuaded that these are workable standards. I just don't think we can categorize all investigations into these rigid time frames. Investigations just are not conducted that way. Thirty days, for example, is probably not even enough time to obtain a license check return from some states. Moreover, limiting an investigation to one year may not be realistic when it applies to investigating a violence prone group like the SLA or a Soviet Union espionage ring. These investigations are not easily or quickly accomplished. I do not believe that the creation of artificial time limits is the best way to approach the real concern of the Committee, which is that we establish institutional controls on domestic security investigations. I would prefer approaching the control and accountability problems by providing periodic Department of Justice reviews of *all* categories of domestic intelligence investigations; not by imposing specific time limits upon all investigations.

(2) INFORMANTS

The Committee recommends broad new restrictions on the use of informants by the FBI. While our investigation has established that, in the domestic intelligence field, there have been numerous abuses in the use of informants, I do not think that the proposed recommendations are the best vehicles to achieve the needed reform. I cannot subscribe to recommendations limiting the use of informants to stringent time standards.²¹ To limit use of informants to periods of "90 days"²² unless the Attorney General finds "probable cause" that an American will "soon" engage in terrorist or hostile foreign intelligence activity is impractical and unworkable. When groups such as the SLA attempt to rob, kill, or blow up buildings, it is clearly necessary to cultivate informants who may provide some advance warning. I am concerned that the Committee's recommendations will preclude this vital function of the FBI. Moreover, specific time limits, it seems to me, will prove to be impractical. For example, at the end of the prescribed time, with not enough evidence for arrests, will informant X be terminated and replaced by informant Y who starts anew, or are informants thereafter banned from penetrating the particular group—even if violence prone or involved in espionage?

It should be remembered that informants are the single most important tool of the FBI, and local police for that matter, in the fight against terrorism and espionage, as well as organized crime, narcotics, and even the ever pervasive street crimes of murder, rape, and robbery. Indeed, they are the very lifeblood of such investigations. Moreover, informants are involved in a wide spectrum of activities

¹⁹ Committee Domestic Report, pp. 320-323.

²⁰ Compelling circumstances is not further defined, so it is unclear what standards should be applied in making such a determination.

²¹ My concerns here parallel those I have with respect to the general investigation standards recommended.

²² The Committee allows an additional 60 days if the Attorney General finds "compelling circumstances."

from attending public meetings to actual penetration attempts. I am concerned that theoretical and abstract restrictions designed only for "domestic intelligence", if enacted, would soon limit our legitimate law enforcement efforts in many other fields as well. People and actions do not always fit nicely in neat little boxes labeled "domestic intelligence," particularly in the terrorist and espionage areas to which the proposed restrictions on informants would apply. Congress should carefully consider the scope and ramifications of any recommendations with respect to informants.

It is my view that the better way to approach the problems encountered in the use of informants is to put their use under strict supervision of the Department of Justice. Creation of a special staff or committee for this purpose, centralized in the Department of Justice, would provide effective controls over the potential abuses in the use of informants, yet not hamstringing their legitimate and valuable use.²³

(3) ELECTRONIC SURVEILLANCE

I wholeheartedly support S. 3197, the new electronic surveillance bill sent to the Congress by President Ford.²⁴ It needs consolidated bipartisan support because it represents a significant advance from existing practice. For the first time, it will bring all governmental electronic surveillance under the scrutiny of judicial warrant procedures. I commend the efforts of President Ford in taking this extraordinary step forward in the regulation of electronic surveillance.

In supporting S. 3197, I do not regard the existing wiretaps presently maintained under the direction and control of Attorney General Levi as being in violation of the Constitution. The present practice of electronic surveillance authorization and implementation rests upon a long-standing body of precedent which provides a firm constitutional base for their continued maintenance. The President's approach is to move from the present practice toward better practices and procedures for authorization. The abuses of electronic surveillance of the past clearly dictate a need for a system of judicial warrant approval. Under the President's proposal the American people will be able to rest easy—assured that electronic surveillance will be employed carefully, yet when needed to combat serious criminal and espionage activity.

I differ with a majority of the Committee insofar as they recommend that before a judge can issue a warrant for electronic surveillance he must find *more* than that an American is a conscious agent of a foreign power engaged in clandestine intelligence activities. The Committee would require that probable cause be established for "criminal activity" before a wiretap can be authorized. I think this departure from the S. 3197 standard would be a dangerous one because it would eliminate certain areas of espionage, particularly industrial espionage,

²³ Attorney General Levi is in the process of establishing guidelines to regulate the use of informants. I recommend, however, that these guidelines be enforced through some appropriate form of Department of Justice review of the FBI's use of informants.

²⁴ The bill enjoyed a bipartisan co-sponsorship of Senators.

from electronic surveillance. Many areas of espionage do not involve clearly criminal activity. Indeed, forms of espionage may not constitute a criminal offense, but should be the valid target of an espionage investigation. For example, a situation such as American oil company executives providing unclassified but important oil reserve information to a Soviet agent might not be a permissible subject of electronic surveillance if "criminal activity," rather than hostile foreign intelligence, were the standard.²⁵ I think the Committee proposed standard would harm the FBI's espionage efforts and would therefore be a mistake.

(4) CIVIL REMEDIES STATUTE

I oppose any broad new civil remedies statute in the field of domestic intelligence as both dangerous and unnecessary. It is dangerous because it could easily open the flood gates for numerous lawsuits filed seeking injunctive relief in the courts to thwart legitimate investigations. It is unnecessary because any substantial actions are already permitted under present Supreme Court decisions, such as *Bivens v. United States*, for violation of constitutional rights. There is simply no valid reason to carve out a broad new category of lawsuits for those not only injured by domestic intelligence methods but "threatened with injury."²⁶ No such statutory provisions are available for "victims" in any other specific category of activity. The present avenues of relief provided by law today are clearly sufficient to address any future abuses in the domestic intelligence field. I note that we have not had the benefit of any sworn testimony from the many constitutional and criminal law experts in the country, either pro or con such a proposal. Without the benefit of an adequate record and with my concern about the practical results of such a statute, I cannot support its enactment.

(5) CIVIL DISORDERS

A final recommendation which requires brief comment in the Committee's proposed standards permitting the FBI to assist "federal, state, and local officials in connection with a civil disorder." The Committee's recommendation will not allow any investigation by the F.B.I., not even preliminary in nature, unless the Attorney General finds in writing that "there is a clear and immediate threat of domestic violence" which will require the use of Federal troops.

My reservation about this recommendation is that I think it deprives the Attorney General of the necessary flexibility in dealing with

²⁵ Those involved in the obtaining of information about our industrial processes, vital to our national security, for our adversaries should be the legitimate subject of electronic surveillance, notwithstanding that no criminal statute is violated. I do not think we can afford to wait for exhaustive reform of our espionage laws. I note that the section of the proposed S.1 dealing with espionage reform has presented great difficulty to the drafters. Indeed, drafting espionage into a criminal statute presents some of the same overbreadth problems that the Committee has been concerned with in the domestic intelligence area.

²⁶ For example, would a cause of action exist simply because X notices a federal agent following him in an automobile, notwithstanding the nature or status of the particular investigation?

these delicate matters (i.e., civil disturbances) and might tend to exacerbate a possibly explosive situation. If the Attorney General is not allowed to dispatch FBI agents to the scene of disorders it seems to me that we deprive him of the very means he needs to make the extraordinarily important decision as to whether Federal troops are likely to be used.

I believe the better practice would be to permit preliminary investigation by the FBI of potentially volatile situations so that the Attorney General might make the most reasoned decision possible with respect to what I consider the drastic step of deploying Federal troops to quell a civil disorder in one of our cities.

WATERGATE-RELATED INQUIRY

Finally, I wish to address briefly an area of the Committee's investigation which I pursued for the most part independently. At the close of the Senate Watergate investigation I filed a report as part of my individual views²⁷ which outlined remaining areas of investigation with respect to the relationships between the Central Intelligence Agency and the former CIA employees who participated in the Watergate break-in.²⁸ By virtue of my membership on this Select Committee, I have been able to pursue a further inquiry into these matters, and wish to thank the Chairman and the Vice Chairman for the staff assistance and latitude provided me to pursue this area of investigation.

Many of the concerns raised in the Watergate Committee investigation have been overtaken by time and events. For example, the reported references to illegal CIA domestic activities have now been confirmed, as described in detail in the Committee's Report. The reference to the CIA maintaining a file on Jack Anderson²⁹ proved to be part of a lengthy investigation and physical surveillance of Anderson by the CIA during a "leak" inquiry. Similarly, the detailing of Howard Hunt's post-retirement contacts with the CIA has been supplemented with still more such contacts.³⁰ Since July 1974, we have witnessed a variety of other disclosures relative to the CIA's domestic activities; indeed, the creation of our Senate Select Committee on Intelligence Activities was due in part to the continuing public concern about these matters.

Unlike the Watergate Committee investigation of CIA activities, which was terminated because of the refusal of the CIA to turn over documents,³¹ this investigation was conducted in an atmosphere of cooperation. After some initial difficulties, which the Committee en-

²⁷ Senate Watergate Committee Final Report, S. Res. 93-881, pp. 1105-1165.

²⁸ The "Action Required" section of the report, at pages 1150-1157, enumerated unresolved matters and identified materials not provided to the Watergate Committee by the CIA.

²⁹ Senate Watergate Committee Final Report, p. 1128.

³⁰ For example this disclosure of personal correspondence (detailing certain of Hunt's activities in 1971 and 1972) between Hunt and the CIA secretary stationed in Paris whom Hunt sought to have reassigned to work for him at the White House.

³¹ By letter of March 7, 1974, former Director Colby informed the Senate Watergate Committee that certain items of requested information would not be made available to that committee. Such a withholding of timely information, including that which was totally exculpatory, unnecessarily focused an aura of suspicion and guilt.

countered in a variety of areas, the cooperation afforded by the CIA was exemplary. In particular, I especially want to express my appreciation to former Director William Colby and present Director George Lush for cooperating to the fullest extent in this investigation. I also want to thank Ambassador Richard Helms and former Counter-intelligence Chief James Angleton for their patience and extensive assistance in numerous conferences, in trying to reconstruct the elusive details of this significant period.

In pursuing this area of inquiry, the Committee staff examined a great volume of highly sensitive material, much of which contained speculative matters and a multitude of information of marginal relevance. This information, which had not been made available in large part to the Separate Watergate Committee, was examined in raw form and without sanitization deletions. Because of the sensitivity of the material, it was reviewed on the Central Intelligence Agency premises. Thus, it was in a spirit of cooperation that this examination was accommodated; and, this experience indicates that the Congress and the intelligence community can cooperate in an investigation without incurring unauthorized disclosure of sensitive information.⁸²

At the close of this Committee's examination of the available record, I wish to state my belief that the sum total of the evidence does not substantiate a conclusion that the CIA per se was involved in the range of events and circumstances known as Watergate.⁸³ However, there was considerable evidence that for much of the post-Watergate period the CIA itself was uncertain of the ramifications of the various involvements, witting or otherwise, between members of the Watergate burglary team and members of components of the Agency. Indeed, the CIA was apparently, at times as perplexed as Congressional investigators.⁸⁴ It should be noted that the Agency undertook an extensive internal inquiry in an effort to resolve these uncertainties. The investigation of Watergate and the possible relationship of the Central Intelligence Agency thereto, produced a panoply of puzzlement. While the available information leaves nagging questions and contains bits and pieces of intriguing evidence, fairness dictates that an assessment be rendered on the basis of the present record. An impartial evaluation of that record compels the conclusion that the CIA, as an institution, was not involved in the Watergate break-in.

HOWARD H. BAKER, JR.

⁸² For example, the staff was given access to the Martinez contact reports (to which access was refused during the Watergate Committee investigation) in their entirety. This review was accomplished in secure facilities at the CIA, and no notes were taken of sensitive information contained in the reports not related to the point or in some other way relevant to the Committee's inquiry. I cite this as an example of how a Congressional investigation can be thorough and yet not threaten the integrity of CIA secret documentation, containing names of officers and other highly classified information.

⁸³ I am filing with the Committee the detailed results of this investigation in the form of classified memoranda. These memoranda will be turned over to the successor permanent oversight committee to be kept in its secure files. No useful purpose would be served in further publicizing the contents, because much of it is fragmentary and its sum total reinforces the findings stated herein.

⁸⁴ Colby to Helms letter of 28 January, 1974, references seven to nine communications from Hunt while he was at the White House to Helms' secretary, with the query: "Can you give us some idea as to what they were about?"

SUPPLEMENTAL VIEWS OF SENATOR CHARLES McC. MATHIAS, JR.

I fully support the Final Report and Findings and Recommendations of the Senate Select Committee on Intelligence Activities.

When the Majority Leader, Senator Mike Mansfield and I first proposed the creation of a Select Committee on Intelligence Activities on October 4, 1974, in the aftermath of Watergate and charges of domestic spying and the misuse of the CIA and the FBI, confidence of the people in our vital government intelligence system was severely strained. It was the Majority Leader's and my view that in order to restore confidence and legitimacy to the intelligence activities of the United States, there was a need to examine in depth to what extent secret activities are required by the United States. In December 1974, in testimony in support of my resolution to create a Senate Select Committee to Study the intelligence activities of the United States, I stated:

One of the most important tasks facing the United States and particularly the Congress is determining the proper role of intelligence agencies in our constitutional system of government and drawing new guidelines for the future intelligence activities of the executive branch. It is quite clear that our foreign and domestic intelligence agencies, including such valued agencies as the CIA, the FBI, and other departments and agencies, have in the course of their activities, violated the constitutional guarantees of citizens and have operated outside of normal constitutional processes. The instances of abuses of power by intelligence agencies and the abridgement of constitutional rights of individual citizens by these agencies revealed by Watergate are sufficient cause to warrant a thorough systematic examination of not only the present intelligence activities; but more importantly, in my view, there is an urgent need to determine what our intelligence needs now are and how they can most effectively function under firm constitutional guidelines, providing for rigorous oversight and accountability.

The Select Committee has just completed this task. Its recommendations represent an agenda of essential legislative and executive branch action.

The history of United States intelligence activities since the end of World War II is a record of remarkable intellectual and organizational achievement. It is also a record of the exercise of subtle violence and brutal warfare. The latter is not a pretty picture, but gives the attitudes of major powers since the end of World War II, our national leadership regarded such measures as necessary and unavoidable. The history of the past three decades raises the important issue of whether the United States must adopt all the methods of our potential adver-

saries, or is able to exercise some restraints. I share the view of the Committee that if we become "more ruthless than the enemy," as one important policy document of the 1950's urged, the U.S. will lose those qualities which distinguish a free society from a totalitarian regime. It is my belief that restraints are possible and can be exercised in ways that are both consistent with the needs of national security and with our constitutional processes.

The information obtained through intelligence activities is important to government at all policy and operational levels. The U.S. spends many billions of dollars a year on this effort. After over a year of study and investigation, there remain, however, many unanswered questions as to the value of some intelligence collection activities. More work needs to be done by a fully empowered permanent oversight committee. For example, in neither the Committee's investigations, nor in internal executive branch studies, has it been possible to determine exactly how much and what kind of intelligence is needed. There are very few solid indicators of the usefulness of the massive amount of intelligence available to the U.S. Government. There are, however, many tangible positive benefits; the ABM Treaty, for example, would not have been possible without reliable intelligence to assure that its provisions were being adhered to.

The magnitude of the intelligence effort parallels the patterns of our military and diplomatic policies against potential enemies. In the early 1950's, the intent of United States policy was to counter and roll back Soviet activities worldwide. In recent years there has been a lessening of tensions between the United States and the Soviet Union. In the world of intelligence similar patterns can be observed.

The intelligence activities of the U.S. are largely shaped by the activities of our potential enemies. We do what they do. What is it that we both do?

First, we spy on one another. The legal term is espionage; the euphemism is "clandestine collection;" the direct word is spying.

Second, we make great efforts to know what it is they are doing in order to counter, stop, or destroy what they are doing against us. Response to potential enemies has tended to set the pace for our intelligence efforts.

Third, we both engage in covert action. Covert action, plainly stated, is the secret exercise of influence. The means used range the gamut of technique between waging war and peaceful intercourse among nations. This includes "little" wars—paramilitary activity, subversion of other governments through propaganda, the use of money, agents of influence, economic warfare, and other less directly hostile means. All this is done to support policy interests.

Fourth, we both collect vast amounts of information through open means, technological collection and spying. This information is analyzed and organized into finished intelligence available to the policy-makers of the country in making national decisions.

Upon systematic review, I share the view of the Committee that the U.S. must continue to undertake some secret intelligence activities. They are vital to our national security. Certain activities, however, should be prohibited. In the past, some intelligence activities have had the effect of eroding our processes of government, have violated our

principles, ideals and reputation, and have damaged our ability to exercise moral and ethical leadership throughout the world. The fundamental issue facing the Congress and the issue that particularly confronts the Committee is to decide how secret activities which are agreed to be necessary are to be governed by our democratic institutions. This issue has three aspects:

First, how do we decide which activities should be undertaken? The answer the Committee has come to and that I fully support is that it must be the executive and legislative branches jointly: The legislature through appropriate legislative intelligence oversight committee(s) and the executive through its NSC and other management and oversight structures.

Second, what system of accountability is necessary in order to assure that intelligence activities are prudent and appropriate? The Committee's decision is that there must be a rigorous recorded approval process within the executive branch and a searching oversight process within the legislative branch. All proposals and approvals for intelligence activities must be recorded in writing and placed in a central classified registry; the record of activities should be available to the legislative oversight committee(s) in accordance with their needs.

Third, who can make use of intelligence information? The Committee's view is that both the legislature and the executive should have full access to the intelligence analyses produced by the intelligence community. The availability of sound intelligence will enable the legislature to become a partner with the executive branch as intended by the Constitution in this vital area of national policy. A better informed legislature can only benefit the nation.

These three questions and their answers are at the heart of the Committee's recommended solutions to the problem of how secret intelligence activities can be governed within an open democratic society. These are solutions which I fully support. But for these solutions to work, a strong oversight committee must be created with power of the purse and full access to information. Without a strong oversight committee, the failures of the past will recur.

Inherent contradictions are created when secret activities are permitted within a democratic society. The U.S. is a government of laws, yet laws have not been passed which accurately describe the nature and extent of intelligence activities. This dilemma has raised a number of important questions for the Committee. Although the Committee has come to conclusions about these issues, they are problems that require constant reexamination.

In this regard, a key question before the Committee was whether the U.S. should be the first nation to say through its laws what it is in fact doing in the world of intelligence activities. Should it pass laws specifically authorizing and governing covert action, including the explicit right to make warfare, to practice subversion and propaganda?

Should these intelligence methods—which have never been publicly acknowledged by any other nation—be put into law? Should the United States Government do so directly and explicitly, rather than through euphemisms and vague imprecise language, and not disguise from its own people what it is actually doing? Is it naive or innocent to express what the U.S. and all other nations in fact are doing? Or

would there be advantages to expressing directly what we and all other nations do, expressing also the hope that through negotiation between nations many activities could be stopped on a mutually acceptable basis?

In response to the question of whether we should express openly what we now do secretly in the world of intelligence, many have answered that to reveal the missions of the intelligence agencies with any precision and to set limitations on them by law would, at a minimum have severe diplomatic repercussions. Further, it is argued, disclosure would, as a practical matter, result in effective countermeasures by the intelligence services of other nations, particularly those nations hostile to the United States.

In the past, all nations have disavowed acts of their intelligence agents abroad when they have been revealed. But as the scale of intelligence activities has grown, "plausible denial," once an accepted doctrine for the U.S. Government, has become implausible. It is my belief that the failure to assure accountability through constitutional processes has jeopardized the integrity of our democratic institutions. Many of the practices and techniques exercised by our nation's intelligence agencies have also become obsolete in this age of nuclear weapons and other advanced technology. For example, there is now recognition, at least for the present, among the great powers that so-called "national technical means," that is, satellite reconnaissance, should not be interfered with. There are a number of intelligence missions which, through tacit international acceptance and widespread press discussion, have, over time and through common usage, become "overt" in fact. In such cases, public discussion and approval of these kinds of intelligence missions, such as technical collection systems, is essential, even if the details are not revealed.

Shall the U.S. Government through laws exempt certain sectors of its society—such as the press, religious institutions, foundations, and the academic world—from any use by the intelligence agencies of the U.S.?

How can the executive and legislative branches of government control necessary but hazardous activities? How can the third branch, the judiciary, safeguard liberties without an adequate statutory foundation? The answers lie, the Committee has concluded in its report, and I fully share this conclusion, in a combination of precise statutory charters and an informed interaction between the oversight committees of the Congress and the appropriate policy groups within the executive branch. If the oversight committees of the Congress are to be effective they must reflect the full spectrum of views of the legislature, they require not only the power of the purse and full access to information, including presentation of proposals before the initiation of significant intelligence activities.

The requirement that the legislature through its oversight committees be fully informed, very quickly raises the question of how fully? What "advice" given to Presidents qualifies as "personal"—therefore privileged—communication as opposed to "decisions" or "facts and analysis" which all agree should be made available to the Congress? The experience of the Select Committee will be a good guide to the problems that oversight committees will face in the future. The execu-

tive branch made the entire record available in some cases. In only a few cases was adequate information not forthcoming. On the one hand, executive privilege was never formally asserted; on the other hand, the Committee insisted upon complete access only when absolutely necessary.

I continue to be deeply troubled by the dilemma created by the necessity for Congress to work through an oversight committee to exact adherence to standards through secret consultations. On the one hand, the agreed-upon needs for secrecy argues for regulation through oversight, rather than through explicit legislation; yet, such a process must be supported by statutes embodying the broad principles of declared policy.

Both the Committee and the executive branch agree that clearly defined statutory charters and a new strong and effective oversight committee for the intelligence agencies are necessary. If the proposed new legislative and executive branch oversight procedures prove insufficient, additional statutory controls can be instituted. But the first and present requirement is full executive and legislative support of the governance of intelligence activities through the newly cast joint oversight mechanisms of the legislative and the executive branches.

This is a time of testing. After 200 years of open democratic government the U.S. now has the burden of a permanent secret intelligence system. If secret intelligence activities are to continue—and there is present agreement between the branches that they are necessary—then the secret procedures required must have built-in checks and especially stringent provisions for accountability. Intelligence agencies have expressed the concern that some of the Committee's proposals will create excessive layers of approval through which actions must be approved, and that such layering will introduce new elements of caution into the approval process which are inconsistent with the view, held by many in the intelligence agencies, that to be effective risks must be taken. But in view of the dangers involved, and the past record of instances of recklessness harmful to the nation there is clearly a need for more caution through more accountability and fixed responsibility in the decisionmaking process governing the initiation and carrying out of intelligence activities.

If such high-risk activities are to continue, and if the decisions concerning secret activities are to remain secret, a thorough and rigorous paper trail must be constructed so that accountability can be fixed among all those involved in any secret intelligence activity approved. The possible drawbacks of a monitoring system of extensive checks and balances are far outweighed by the dangers of unchecked secret activities. The record of abuses in the past is sufficient warning.

In time of peace a rigorously enforced system of checks and accountability is necessary for the preservation of a free society.

In my view, the purposes of our intelligence system are many. The major purpose, however, is the prevention of war. The recommendations made by the Committee for legislative charters and an informed interaction between the legislative and executive branches are designed to assure that our intelligence system operates effectively, accountably, and under the governance of constitutional processes.

CHARLES McC. MATHIAS, Jr.



ADDITIONAL VIEWS OF SENATOR RICHARD S. SCHWEIKER

The Senate Select Committee has engaged in an extensive investigation of the intelligence activities of the United States. The investigation did not cover all alleged abuses or study in depth all the major issues. It was, however—and this is more a matter of concern than a matter of pride—the first thorough investigation of the United States intelligence community in almost thirty years.

The Committee discovered the real strengths of American intelligence activities—dedicated personnel, broad expertise, and impressive technological achievements. But we also found real weaknesses. Among these is the absence of statutory authority for many intelligence activities. Combined with this lack of explicit authorization were two noteworthy beliefs. First, that a claim of national security, however, defined or understood, could supersede the laws or regulations that govern other activities. Second, that if our enemies were engaging in certain activities we could, and should, do the same.

The coming to maturity of the American intelligence community will help eliminate these pernicious beliefs. The recommendations which the Committee made, which I strongly support, will help to bring intelligence activities under law. Crucial to the success of the Committee's recommendations—and here I join with my colleagues, Senators Philip Hart, Walter Mondale and Gary Hart—is the establishment of a new intelligence oversight committee with legislative authority.

Our Committee did not have such authority. As a select committee we have had a limited mandate and a limited life. Thus we have had only one tool with which to accomplish reform—public disclosure, leading to public concern.

The Committee has been in a constant dilemma. Should it use the one tool available—public disclosure of certain intelligence activities—even though it was claimed that almost any disclosure would damage the "national security"? For example, the Central Intelligence Agency argued that references to the invasion of the Bay of Pigs should be eliminated on such grounds. Or should it withhold information such as the fact that NSA was given access to millions of messages and risk well-deserved cover-up charges? I think, in general, the Committee chose the right balance.

But an oversight committee with power to bring legislation to the floor and power to authorize the budget for national intelligence will not have to face this dilemma. Such a committee could and should disclose enough information to enable the public to understand how the intelligence community works or fails to work. Such a committee can and will protect vital secrets. And it can, in executive session, continue the intensive scrutiny of intelligence activities which was absent in the past and which is necessary because these activities cannot be completely open to public examination.

RICHARD S. SCHWEIKER.

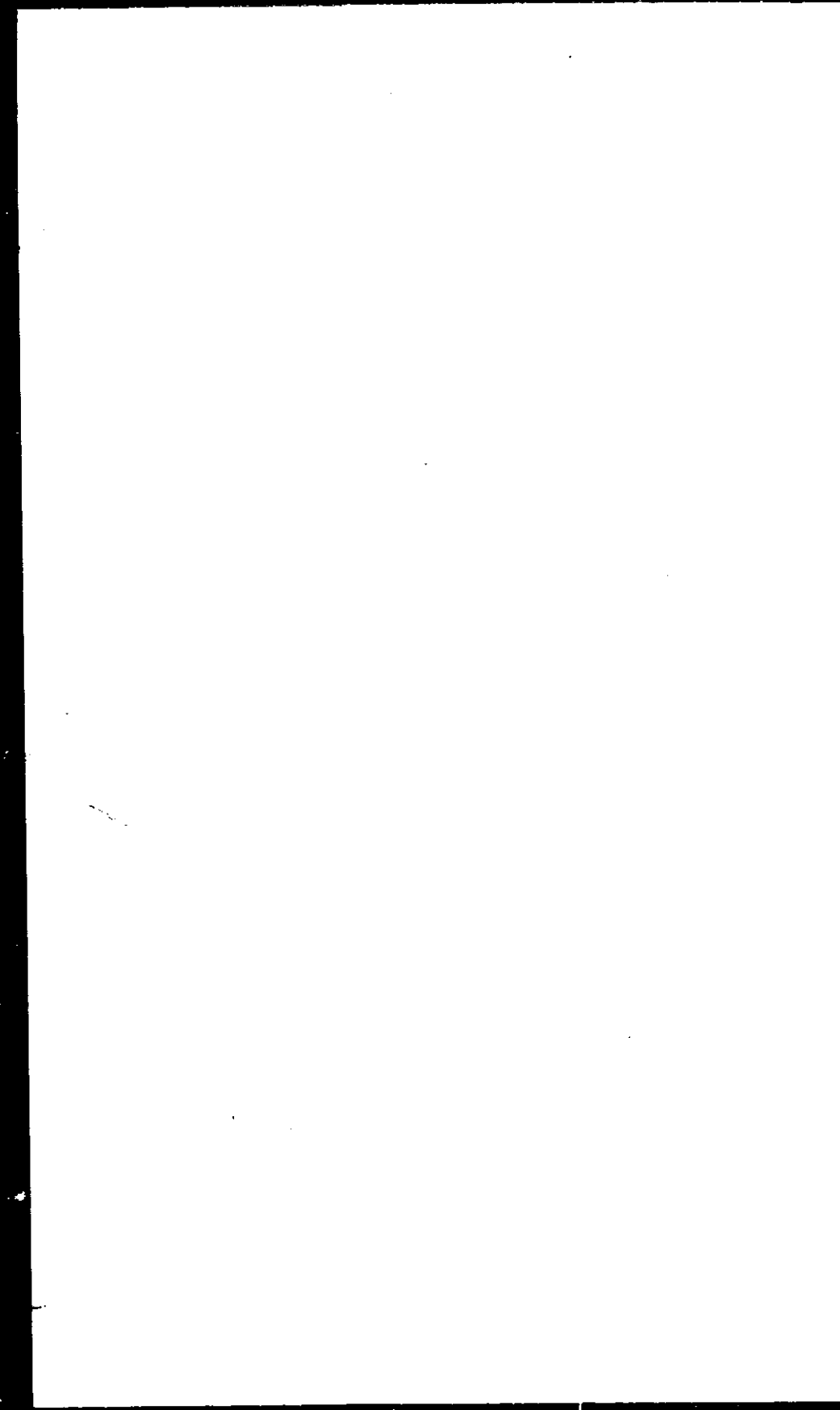

GLOSSARY

- Ad Hoc Requirements Committee*: An interagency group established in 1955 by the Special Assistant to the DCI to coordinate collection requirements for the U-2 reconnaissance program.
- Agent*: An individual who acts under the direction of an intelligence agency or security service to obtain, or assist in obtaining, information for intelligence or counterintelligence purposes.
- Agent of Influence*: An individual who can be used to influence covertly foreign officials, opinion molders, organizations, or pressure groups in a way which will generally advance United States Government objectives, or to undertake specific action in support of United States Government objectives.
- Analysis*: A stage in the intelligence processing cycle whereby collected information is reviewed to identify significant facts; the information is compared with and collated with other data, and conclusions, which also incorporate the memory and judgment of the intelligence analyst, are derived from it.
- Armed Forces Security Agency (AFSA)*: The predecessor to NSA; it was created in 1949 to consolidate the cryptologic effort.
- Army Security Agency (ASA)*: One of the Service Cryptologic Agencies; its collection activities are under the authority of the Director of NSA (DIRNSA) in his dual role as Chief of the Central Security Service (CSS).
- Asset*: Any resource—a person, group, relationship, instrument, installation, or supply—at the disposition of an intelligence agency for use in an operational or support role. The term is normally applied to a person who is contributing to a CIA clandestine mission, but is not a fully controlled agent of CIA.
- Assessment*: Part of the intelligence process whereby an analyst determines the reliability or validity of a piece of information. An assessment could also be a statement resulting from this process.
- Backstopping*: A CIA term for providing appropriate verification and support of cover arrangements for an agent or asset in anticipation of inquiries or other actions which might test the credibility of his or its cover.
- Basic Intelligence*: Factual, fundamental, and generally permanent information about all aspects of a nation—physical, social, economic, political, biographical, and cultural—which is used as a base for intelligence products in support of planning, policymaking, and military operations.
- Bigot Lists*: Using the term bigot in the sense of “narrow,” this is a restrictive list of persons who have access to a particular, and highly sensitive class of information.
- Biological Agent*: A micro-organism which causes disease in humans, plants, or animals, or causes a deterioration of materiel.

- Biological Operations:** Employment of biological agents to produce casualties in humans or animals, and damage to plants or material; or a defense against such an attack.
- Biological Warfare:** Use of living organisms, toxic biological products, or plant growth regulators to cause death or injury to humans, animals, or plants; or a defense against such an action.
- Biological Weapon:** A weapon which projects, disperses, or disseminates a biological agent.
- Black:** A term used to indicate reliance on illegal concealment of an activity rather than on cover.
- Black Bag Job:** Warrantless surreptitious entry, especially an entry conducted for purposes other than microphone installation, such as physical search and seizure or photographing of documents.
- Black List:** An official counterintelligence listing of actual or potential hostile collaborators, sympathizers, intelligence suspects, or other persons viewed as threatening to the security of friendly military forces.
- Black Propaganda:** Propaganda which purports to emanate from a source other than the true one.
- Blow:** To expose—often unintentionally—personnel, installations, or other elements of a clandestine activity or organization.
- Board of National Estimates (BNE):** Established in 1950 by DCI Walter Bedell Smith. The Board was composed of individuals who had responsibility for receiving National Intelligence Estimates for the Director of Central Intelligence. The Board was dissolved in 1973.
- Bug:** A concealed listening device or microphone, or other audiosurveillance device; also, to install the means for audiosurveillance of a subject or target.
- Bugged:** A room or object which contains a concealed listening device.
- Case:** An intelligence operation in its entirety; the term also refers to a record of the development of an intelligence operation, how it will operate, and the objectives of the operation.
- Case Officer:** A staff employee of the CIA who is responsible for handling agents.
- Central Intelligence Group (CIG):** The direct predecessor to CIA; President Truman established it by executive order on January 22, 1946. It operated under the National Intelligence Authority (NIA), which was created at the same time.
- Chemical Agent:** A chemical compound which, when disseminated, causes incapacitating, lethal, or damaging effects on humans, animals, plants, or materials.
- Chemical Operations:** Using chemical agents—excluding riot control agents—to kill, or incapacitate for a significant period, humans or animals, or to deny the use of facilities, materials, or areas.
- Cipher:** Any cryptographic system in which arbitrary symbols or groups of symbols represent units of plain text.
- Clandestine Intelligence:** Intelligence information collected by clandestine sources.
- Clandestine Operations:** Intelligence, counterintelligence, or other information collection activities and covert political, economic, propaganda and paramilitary activities, conducted so as to assure the secrecy of the operation.

- Code:** A system of communication in which arbitrary groups of symbols represent units of plain text. Codes may be used for brevity or for security.
- Code word:** A word which has been assigned a classification and a classified meaning to safeguard intentions and information regarding a planned operation.
- Collation:** The assembly of facts to determine the relationships among them in order to derive intelligence and facilitate further processing of intelligence information.
- Collection:** The acquisition of information by any means and its delivery to the proper intelligence processing unit for use in the production of intelligence.
- Committee on Imagery Requirements and Exploitation (COMIREX):** One of three intelligence collection committees formerly under the United States Intelligence Board (USIB), dealing with photographic intelligence.
- Communications:** A method or means of conveying information from one person or place to another; this term does not include direct, unassisted conversion or correspondence through nonmilitary postal agencies.
- Communications Center:** A facility responsible for receiving transmitting and delivering messages; it normally contains a message center section, a cryptographic section, and a sending and receiving section, using electronic communications devices.
- Communications Intelligence (COMINT):** Technical and intelligence information derived from foreign communications by someone other than the intended recipient. It does not include foreign press, propaganda, or public broadcasts. The term is sometimes used interchangeably with SIGINT.
- Communications Security (COMSEC):** The protection of United States telecommunications and other communications from exploitation by foreign intelligence services and from unauthorized disclosure. COMSEC is one of the mission responsibilities of NSA. It includes cryptosecurity, transmission security, emission security, and physical security of classified equipment, material, and documents.
- Compartmentation:** The practice of establishing special channels for handling sensitive intelligence information. The channels are limited to individuals with a specific need for such information and who are therefore given special security clearances in order to have access to it.
- Compromise:** A known or suspected exposure of clandestine personnel, installations, or other assets, or of classified information or material, to an unauthorized person.
- Concealment:** The provision of protection from observation only.
- Confusion Agent:** An individual dispatched by his sponsor to confound the intelligence or counterintelligence apparatus of another country rather than to collect and transmit information.
- Consumer:** A person or agency that uses information or intelligence produced by either its own staff or other agencies.
- Continental United States (CONUS):** A military term which refers to United States territory, including adjacent territorial waters,

located within the North American continent between Canada and Mexico.

Control: Physical or psychological pressure exerted on an agent or group to ensure that the agent or group responds to the direction from an intelligence agency or service.

Counterespionage: Those aspects of counterintelligence concerned with aggressive operations against another intelligence service to reduce its effectiveness, or to detect and neutralize foreign espionage. This is done by identification, penetration, manipulation, deception, and repression of individuals, groups, or organizations conducting or suspected of conducting espionage activities in order to destroy, neutralize, exploit, or prevent such espionage activities.

Counterguerrilla Warfare: Operations and activities conducted by armed forces, paramilitary forces, or nonmilitary agencies of a government against guerrillas.

Counterinsurgency: Military, paramilitary, political, economic, psychological, and civic actions taken by a government to defeat subversive insurgency within a country.

Counterintelligence: Activities conducted to destroy the effectiveness of foreign intelligence operations and to protect information against espionage, individuals against subversion, and installations against sabotage. The term also refers to information developed by or used in counterintelligence operations. See also counterespionage, countersabotage, and countersubversion.

Counterreconnaissance: Measures taken to prevent observation by a hostile foreign service of an area, place, or military force.

Countersabotage: That aspect of counterintelligence designed to detect, destroy, neutralize, or prevent sabotage activities through identification, penetration, manipulation, deception, and repression of individuals, groups, or organizations conducting or suspected of conducting sabotage activities.

Countersubversion: That part of counterintelligence designed to destroy the effectiveness of subversive activities through the detection, identification, exploitation, penetration, manipulation, deception, and repression of individuals, groups, or organizations conducting or capable of conducting such activities.

Courier: A messenger responsible for the secure physical transmission and delivery of documents and material.

Cover: A protective guise used by a person, organization, or installation to prevent identification with clandestine activities and to conceal the true affiliation of personnel and the true sponsorship of their activities.

Covert Action: Any clandestine activity designed to influence foreign governments, events, organizations, or persons in support of United States foreign policy. Covert action may include political and economic action, propaganda and paramilitary activities.

Covert Operations: Operations planned and executed against foreign governments, installations, and individuals so as to conceal the identity of the sponsor or else to permit the sponsor's plausible denial of the operation. The terms covert action, covert operation,

clandestive operation and clandestine activity are sometimes used interchangeably.

- Critical Intelligence:** Information or intelligence of such urgent importance to the security of the United States that it is transmitted at the highest priority to the President and other national decisionmaking officials before passing through regular evaluative channels.
- Cryptanalysis:** The breaking of codes and ciphers into plain text without initial knowledge of the key employed in the encryption.
- Cryptography:** The enciphering of plain text so that it will be unintelligible to an unauthorized recipient.
- Cryptology:** The science that includes cryptanalysis and cryptography, and embraces communications intelligence and communications security.
- Cryptomaterial:** All material—including documents, devices, equipment, and apparatus—essential to the encryption, decryption, or authentication of telecommunications.
- Cryptosecurity:** That component of communications security which results from the provision of technically sound cryptosystems and their proper use.
- Cryptosystems:** The associated items of cryptomaterial which are used as a unit and provide a single means of encryption and decryption.
- Current Intelligence:** Summaries and analyses of recent events.
- Cut-out:** A CIA term referring to a person who is used to conceal contact between members of a clandestine activity or organization.
- Deception:** Measures designed to mislead a hostile person or entity by manipulating, distorting, or falsifying evidence to induce a reaction prejudicial to his or its interests.
- Decrypt:** To convert encrypted text into plain text by use of a cryptosystem.
- Defector:** A person who, for political or other reasons, has repudiated his country and may be in possession of information of interest to the United States Government.
- Defense Intelligence Agency (DIA):** Department of Defense agency for producing military intelligence, created by directive of the Secretary of Defense in 1961.
- Defense Intelligence Objectives and Priorities (DIOP):** A single statement of intelligence requirements compiled by DIA for use by all DOD intelligence components.
- Departmental Intelligence:** The intelligence which government departments and agencies generate in support of their own activities.
- Directive:** Basically any executive branch communication which initiates or governs departmental or agency action, conduct, or procedure.
- Director of Central Intelligence Directive (DCID):** A directive issued by the DCI which outlines general policies and procedures to be followed by intelligence agencies under his direction; it is generally more specific than an NSCID.
- Dissemination:** The distribution of information or intelligence products (in oral, written, or graphic form) to departmental and agency intelligence consumers.

- Domestic Emergencies:** Emergencies occurring within the United States, its territories, or possessions, which affect the public welfare. Such emergencies may arise from an enemy attack, insurrection, civil disturbances, natural disasters (earthquakes, floods), fire, or other comparable emergencies which endanger life and property or disrupt the normal processes of government.
- Domestic Intelligence:** Intelligence relating to activities or conditions within the United States which threaten internal security (in general or to a governmental department, agency, or official) and which might require the employment of troops.
- Double Agent:** A person engaging in clandestine activity for two or more intelligence or security services who provides information to one service about the other, or about each service to the other, and who is wittingly or unwittingly manipulated by one service against the other.
- Economic Intelligence:** Intelligence regarding foreign economic resources, activities, and policies.
- Electromagnetic Spectrum:** The frequencies (or wave lengths) present in a given electromagnetic radiation (radiation made up of oscillating electric and magnetic fields and propagated with the speed of light—such as radar or radio waves). A particular spectrum could include a single frequency, or a broad range of frequencies.
- Electronic Intelligence (ELINT):** Technical and intelligence information derived from the collection (or interception) and processing of foreign electromagnetic radiations (noncommunications) emanating from sources such as radar. ELINT is part of the NSA/CSS Signals Intelligence mission.
- Electronic Line of Sight:** The path traveled by electromagnetic waves which is not subject to reflection or refraction by the atmosphere.
- Electronics Security:** The detection, identification, evaluation, and location of foreign electromagnetic radiations.
- Electronic Surveillance:** Surveillance conducted on a person, group, or other entity by electronic equipment which is often highly sophisticated and extremely sensitive.
- Elicitation:** The acquisition of intelligence from a person or group which does not disclose the intent of the interview or conversation. This is a HUMINT collection technique, generally of an overt nature, unless the collector is other than what he or she purports to be.
- Emission Security:** That component of communications security which results from all measures taken to deny unauthorized persons any information of value which might be derived from the interception and analysis of compromising emanations from crypty-equipment or telecommunications systems.
- Encipher:** To convert a plain text message into unintelligible form by the use of a cipher system.
- Encrypt:** To convert a plain text message into unintelligible form by means of a cryptosystem; this term covers the meanings of encipher and encode.

- Entity:** A company, firm, corporation, institution, bank, or foundation.
- Espionage:** Clandestine intelligence collection activity. This term is often interchanged with "clandestine collection."
- Estimating:** An effort to appraise and analyze the future possibilities or courses of action in a situation under study and the various results or consequences of foreign or United States actions relating to that situation. This analysis of such a foreign situation would consider its development and trends to identify its major elements, interpret the significance of the situation, and evaluate the future possibilities and prospective results of various actions which might be taken, including clandestine operations.
- Evaluation:** The process of determining the value, credibility, reliability, pertinency, accuracy, and use of an item of information, an intelligence product, or the performance of an intelligence system.
- Executive Action:** This term is generally an euphemism for assassination, and was used by the CIA to describe a program aimed at overthrowing certain foreign leaders, by assassinating them if necessary.
- Exploitation:** The process of getting information from any source and taking full advantage of it for strategic or tactical purposes.
- Foreign Intelligence:** Intelligence concerning areas outside the United States.
- Grey Propaganda:** Propaganda which does not specifically identify a source.
- Guerrilla:** A combat participant in guerrilla warfare.
- Guerrilla Warfare:** Military and paramilitary operations conducted in hostile or enemy-held territory by irregular, generally indigenous forces.
- Guidance:** The general direction of an intelligence effort, particularly in the area of collection.
- Imagery:** Representations of objects reproduced electronically or by optical means on film, electronic display devices, or other media.
- Indications Intelligence:** Intelligence in various degrees of evaluation which bears on foreign intentions regarding a course of action.
- Infiltration:** The placing of an agent or other person in a target area within hostile territory or within targeted groups or organizations.
- Informant:** A person who wittingly or unwittingly provides information to an agent, a clandestine service, or police. In reporting such information, this person will often be cited as the source.
- Information:** Raw, unevaluated data at all levels of reliability and from all kinds of sources, such as observation, rumors, reports, and photographs, which, when processed, may produce intelligence.
- Informer:** One who intentionally discloses information about other persons or activities to police or a security service (such as the FBI), usually for a financial reward.
- Insurgency:** A condition resulting from a revolt or insurrection against a constituted government which falls short of civil war.

Intelligence: The product resulting from the collection, collation, evaluation, analysis, integration, and interpretation of all collected information.

Intelligence Collection Plan: A plan for gathering information from all available sources to meet an intelligence requirement.

Intelligence Contingency Funds: Appropriated funds to be used for intelligence activities which are unforeseen at the time of the budget and when the use of other funds is not applicable or would jeopardize or impede the task of an intelligence unit. Such funds are almost invariably used for covert activities.

Intelligence Cycle: The steps by which information is assembled, converted into intelligence, and made available to consumers. The cycle is composed of four basic phases: (1) *direction*: the determination of intelligence requirements, preparation of a collection plan, tasking of collection agencies, and a continuous check on the productivity of these agencies; (2) *collection*: the exploitation of information sources and the delivery of the collected information to the proper intelligence processing unit for use in the production of intelligence; (3) *processing*: the steps whereby information becomes intelligence through evaluation, analysis, integration, and interpretation; and (4) *dissemination*: the distribution of information or intelligence products (in oral, written, or graphic form) to departmental and agency intelligence consumers.

Intelligence Data Base: All holdings of intelligence data and finished intelligence products at a given department or agency.

Information Data Handling Systems: Information systems that process and manipulate raw information and intelligence data. The systems are characterized by application of general-purpose computers, peripheral data processing equipment, and automated storage and retrieval equipment for documents and photographs.

Intelligence Estimate: An appraisal of intelligence elements relating to a specific situation or condition to determine the courses of action open to an enemy or potential enemy and the probable order of their adoption.

Intelligence Process: Those steps by which information is collected, converted into intelligence, and disseminated.

Intelligence Requirement: A consumer statement of information needed which is not already at hand.

Intelligence Resources Advisory Committee (IRAC): Established in 1971 to advise the DCI in preparing a consolidated intelligence program budget for the President. It was abolished by President Ford's Executive Order, No. 11905, 2/18/76.

Interception: This term generally refers to the collection of electromagnetic signals (such as radio communications) by sophisticated collection equipment without the knowledge of the communicants for the production of certain forms of signals intelligence.

Interdepartmental Intelligence: The synthesis of departmental intelligence which is required by departments and agencies of the United States Government for performance of their missions; such intelligence is viewed as transcending the exclusive production competence of a single department or agency.

International Lines of Communication (ILO): Commercial telecommunications links.

Interrogation: A systematic effort to procure information by direct questioning of a person under the control of the questioner.

Interview: The gathering of information from a person who knows that he or she is giving information, although not often with awareness of the true connection or purposes of the interviewer. This is generally an overt collection technique, unless the interviewer is not what he or she purports to be.

Joint Intelligence: Intelligence produced by elements of more than one military service.

Joint Intelligence Estimate for Planning (JIEP): A worldwide series of strategic estimates prepared annually by DIA for the Joint Chiefs of Staff; it is intended to be used as a base for developing intelligence annexes for JCS plans.

Key Intelligence Question (KIQ): Topics of particular importance to national policymakers, as defined by the DCI.

Link Encryption: The application of on-line crypto-operations to a communications system link so that all information passing over it is totally encrypted.

Links of Communication: "Links" is a general term used to indicate the existence of a communications facility between two points.

Microwave Relay: A process for propagating telecommunications over long distances by using radio signals relayed by several stations within "line of sight" from one another.

Monitoring: The observing, listening to, or recording of foreign or domestic communications for intelligence collection or intelligence security (e.g., COMSEC) purposes.

Multiplexing: A technique which allows one signal to carry several communications (e.g., conversations, messages) simultaneously.

National Intelligence: Intelligence produced by the CIA which bears on the broad aspects of United States national policy and national security. It is of concern to more than one department or agency.

National Intelligence Authority (NIA): An executive council created by President Truman's executive order of January 22, 1946, which had authority over the simultaneously created Central Intelligence Group (CIG). The NIA was a predecessor to the National Security Council.

National Intelligence Estimate (NIE): An estimate authorized by the DCI of the capabilities, vulnerabilities, and probable courses of action of foreign nations. It represents the composite views of the intelligence community.

National Security Agency (NSA): Established by President Truman, October 24, 1952, to replace the Armed Forces Security Agency (AFSA).

National Security Council Intelligence Directive (NSCID): Intelligence guidelines issued by the NSC to intelligence agencies. NSCIDs are often augmented by more specific DCIDs and by internal departmental or agency regulations.

Net Assessment Group: The group within the NSC staff that was responsible for reviewing and evaluating all intelligence products and producing net assessments. It was abolished in June 1973.

- Notionals:** Fictitious, private commercial entities which exist on paper only. They serve as the ostensible employer of intelligence personnel, or as the ostensible sponsor of certain activities in support of clandestine operations.
- Office of Policy Coordination (OPC):** An office in CIA, established in 1948, to carry out covert action missions assigned to CIA by the National Security Council.
- Office of Special Operations (OSO):** Prior to 1952, OSO was a CIA component responsible for espionage and counterespionage. It merged with CIA's Office of Policy Coordination to form the Directorate for Plans.
- Office of Strategic Services (OSS):** The United States Intelligence service active during World War II. It was established by President Roosevelt in June 1942, and disbanded October 1, 1945.
- Operational Intelligence:** Intelligence produced to support the planning and execution of operations.
- Operational Use:** This term refers to using a person, group, organization, information, etc. in a clandestine operation or in support of a clandestine activity.
- Operations Coordinating Board (OCB):** This replaced the Psychological Strategy Board of the NSC on September 2, 1953.
- Order of Battle:** This term refers to information regarding the identity, strength, command structure, and disposition of personnel, units, and equipment of any military force.
- Overt Intelligence:** Information collected openly from public or open sources.
- Paramilitary Forces:** Forces or groups which are distinct from the regular armed forces of a nation, although they may resemble regular forces in organization, equipment, training, or mission.
- Paramilitary Operation:** An operation undertaken by a paramilitary force.
- Penetration:** The recruitment of agents within, or the planting of agents or technical monitoring devices within, a target organization to gain access to its secrets or to influence its activities.
- Photographic Intelligence (PHOTINT):** Information or intelligence derived from photography through photographic interpretation.
- Plain Text:** Unencrypted communications; specifically, the original message of a cryptogram, expressed in ordinary language.
- Planning and Coordination Group (PCG):** A committee of the Operations Coordinating Board of the National Security Council. PCG became the normal channel for policy approval of covert operations under NSC directive 5412/1 in 1955.
- Plausible Denial:**
- Plumbing:** A term referring to the development of assets or services supporting the clandestine operations of CIA field stations—such as safehouses, unaccountable funds, investigative persons, surveillance teams.
- Political Intelligence:** Originally, arranging, coordinating and conducting covert operations so as to "plausibly" permit official denial of United States involvement, sponsorship or support. Later this concept evolved so that it was employed by high officials and their subordinates to communicate without using precise language

which would reveal authorization and involvement in certain activities and would be embarrassing and politically damaging if publicly revealed.

Processing: The manipulation of collected raw information to make it usable in analysis or to prepare it for data storage or retrieval.

Product: Finished intelligence reports disseminated by intelligence agencies to appropriate consumers.

Production: The preparation of reports based on an analysis of information to meet the needs of intelligence users (consumers) within and outside the intelligence community.

Propaganda: Any communication supporting national objectives which is designed to influence opinions, emotions, attitudes, or behavior of any group in order to benefit the sponsor, either directly or indirectly.

Proprietaries: A term used by CIA to designate ostensibly private commercial entities capable of doing business which are established and controlled by intelligence services to conceal governmental affiliation of intelligence personnel and/or governmental sponsorship of certain activities in support of clandestine operations.

Psychological Strategy Board (PSB): An NSC subcommittee established in 1951 to determine the desirability of proposed covert action programs and major covert action projects.

Psychological Warfare: The planned use of propaganda and other psychological actions to influence the opinions, emotions, attitudes, and behavior of hostile foreign groups so as to support the achievement of national policy objectives.

Reconnaissance: A mission undertaken to obtain, by observation or other detection methods, information about the activities and resources of foreign states.

Requirement: A general or specific request for intelligence information made by a member of the intelligence community.

Safe House: An innocent-appearing house or premises established by an intelligence organization for conducting clandestine or covert activity in relative security.

Sanitize: The deletion or revision of a report or document so as to prevent identification of the intelligence sources and methods that contributed to or are dealt with in the report.

Scan: In electromagnetic or acoustical contexts, a scan is one complete rotation of an antenna. With regard to ELINT, it refers to the motion of an electronic beam through space which is searching for a target.

Scientific and Technical Intelligence: Information or intelligence concerning foreign progress in basic and applied scientific or technical research and development, including engineering R&D, new technology, and weapons systems.

Security Measures: taken by the government and intelligence departments and agencies, among others, for protection from espionage, observation, sabotage, annoyance, or surprise. With respect to classified materials, it is the condition which prevents unauthorized persons from having access to official information which is safeguarded in the interests of national defense.

Sensitive: Something which requires special protection from disclosure, which could cause embarrassment, compromise, or threat to the security of the sponsoring power.

Service Cryptologic Agencies (SCAs): These are the Army Security Agency, Naval Security Group Command, and Air Force Security Service. Their signals intelligence-collection functions were brought under the operational control of the Director of NSA when the SCAs were confederated into the Central Security Service in 1971, and the Director of NSA was given extra responsibility as Chief of the CSS.

Sheep Dipping: The utilization of a military instrument (e.g., an airplane) or officer in clandestine operations, usually in a civilian capacity or under civilian cover, although the instrument or officer will covertly retain its or his military ownership or standing. The term is also applied to the placement of individuals in organizations or groups in which they can become active in order to establish credentials so that they can be used to collect information of intelligence interest on similar groups.

Signal: As applied to electronics, any transmitted electrical impulse.

Signals Intelligence (SIGINT): The general term for the foreign intelligence mission of the NSA/CSS; SIGINT involves the interception, processing, analysis, and dissemination of information derived from foreign electrical communications and other signals. It is composed of three elements: Communications Intelligence (COMINT), Electronics Intelligence (ELINT), and Telemetry Intelligence (TELINT). Most SIGINT is collected by personnel of the Service Cryptologic Agencies.

Source: A person, thing, or activity which provides intelligence information. In clandestine activities, the term applies to an agent or asset, normally a foreign national, being used in an intelligence activity for intelligence purposes. In interrogations, it refers to a person who furnishes intelligence information with or without knowledge that the information is being used for intelligence purposes.

Special Agent: A United States military or civilian who is a specialist in military security or in the collection of intelligence or counter-intelligence information.

Special Group (Augmented): A NSC subcommittee established in 1962 to oversee Operation MONGOOSE, a major CIA covert action program designed to overthrow Fidel Castro.

Special Group (CI): The Special Group on Counter Insurgency, established by NSAM 124 on 1/18/63 to ensure the design of effective interagency programs to prevent and resist insurgency. Paramilitary operations were a prime focus.

5412/Special Group: An NSC subcommittee that was the predecessor to the 40 Committee.

Special Operations Division (SOD): A facility at Fort Detrick, Maryland that was the site for research and some testing and storage of biological and chemical agents and toxins.

Sterilize: To remove from material to be used in covert and clandestine actions any marks or devices which can identify it as originating with the sponsoring organization or nation.

Strategic Intelligence: Intelligence required for the formation of policy and military plans and operations at the national and international levels.

Subversion: Actions designed to undermine the military, economic, political, psychological, or moral strength of a nation or entity. It can also apply to an undermining of a person's loyalty to a government or entity.

Surreptitious Entry:

Surveillance: Systematic observation of a target.

Tactical Intelligence: Intelligence supporting military plans and operations at the military unit level. Tactical intelligence and strategic intelligence differ only in scope, point of view, and level of employment.

Target: A person, agency, facility, area, or country against which intelligence operations are directed.

Targeting: In regard to COMINT, the intentional selection and/or collection of telecommunications for intelligence purpose.

Target of Opportunity: A term describing an entity (e.g., governmental entity, installation, political organization, or individual) that becomes available to an intelligence agency or service by chance, and provides the opportunity for the collection of needed information.

Task: A term connoting the assignment or direction of an intelligence unit to perform a specified function.

Telecommunications: Any transmission, emission, or reception of signals, signs, writing, images, and sounds or information of any nature by wire, radio, visual, or other electromagnetic systems.

10/5 Panel: A predecessor to the 40 Committee of the NSC.

303 Committee: A predecessor to the 40 Committee of the NSC.

Toxin: Chemicals which are not living organisms, but which are produced by living organisms and are lethal.

Traffic: Messages carried over a telecommunications network.

United States Country Team: The senior, in-country, United States coordinating and supervising body, headed by the Chief of the United States diplomatic mission (usually an ambassador) and composed of the senior member of each represented United States department or agency.

United States Intelligence Board (USIB): Until it was abolished by Executive Order No. 11905 2/18/76, USIB was the NSC's central coordinating committee for the intelligence community.

Watch List: A list of words—such as names, entities, or phrases—which can be employed by a computer to select out required information from a mass of data.

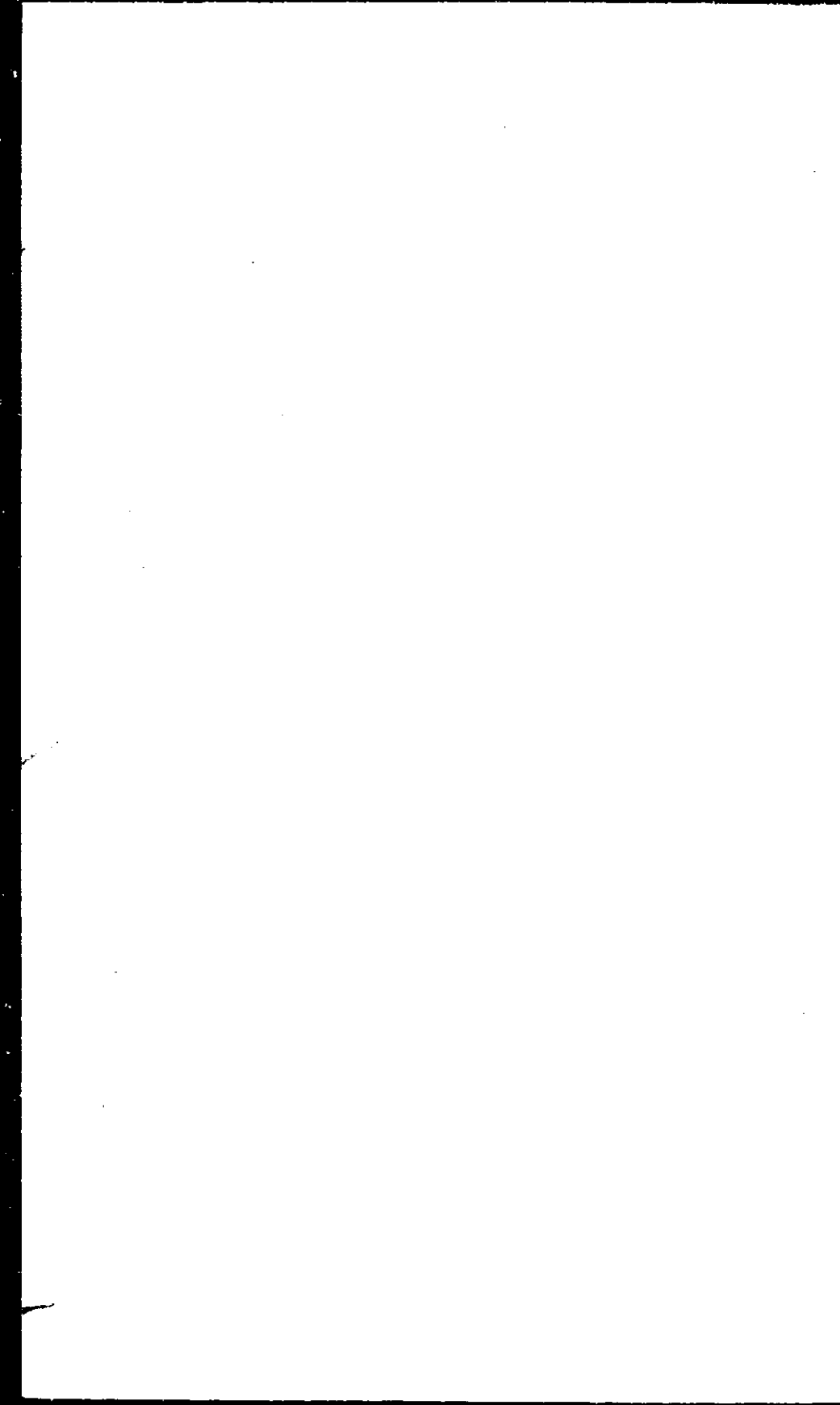

LIST OF ABBREVIATIONS

Abbreviations

- ACDA—Arms Control and Disarmament Agency.
ACS (I)—Army Chief of Staff for Intelligence.
AFOSI—Air Force Office of Special Investigations.
AFSA—Armed Forces Security Agency.
ARC—Ad Hoc Requirements Committee.
ASA—Army Security Agency.
ASD/I—Assistant Secretary of Defense for Intelligence.
ASD/PA&E—Assistant Secretary of Defense for Program Analysis and Evaluation.
ASW—Antisubmarine Investigation.
BI—Background Investigation.
BNDD—Bureau of Narcotics and Dangerous Drugs.
BNE—Board of National Estimates.
CDIB—Consolidated Defense Intelligence Budget.
CDIP—Consolidated Defense Intelligence Program.
CFI—Committee on Foreign Intelligence.
CIA—Central Intelligence Agency.
CI&IA—Counterintelligence and Investigative Activity.
CIG—Central Intelligence Group.
CIRL—Current Intelligence Reporting List.
CJCS—Chairman, Joint Chiefs of Staff.
COMINT—Communications Intelligence.
COMIREX—Committee on Imagery Requirements and Exploitation.
COMOR—Committee on Overhead Reconnaissance.
COMSEC—Communications Security.
CONUS—Continental United States.
CSS—Central Security Service.
DAS—Defense Attaché System.
DCI—Director of Central Intelligence.
DCID—Director of Central Intelligence Directive.
DCII—Defense Central Index of Investigations.
DDA—Deputy Director for Administration, CIA, or Directorate for Administration.
DDCI—Deputy Director of Central Intelligence.
DDI—Deputy Director for Intelligence, CIA, or Directorate for Intelligence.
DDO—Deputy Director for Operations, CIA, or Directorate for Operations.
DDP—Deputy Director for Plans, CIA, or Directorate for Plans.
DDR—Deputy Director for Research, CIA.
DDS&T—Deputy Director of Science and Technology, CIA, or Directorate for Science and Technology.
DDS—Deputy Director for Support, CIA.

DIA—Defense Intelligence Agency.
 DIOP—Defense Intelligence Objectives and Priorities.
 DIPO—Defense Investigative Program Office.
 DIRC—Defense Investigative Review Council.
 DIRDIA—Director of the Defense Intelligence Agency.
 DIRNSA—Director of the National Security Agency.
 DIS—Defense Investigative Service.
 KKIQs—Defense Key Intelligence Questions.
 DMA—Defense Mapping Agency.
 DOD—Department of Defense.
 DOJ—Department of Justice.
 ELINT—Electronic Intelligence.
 ERDA—Energy Research and Development Administration.
 EXCOM—Executive Committee.
 FBI—Federal Bureau of Investigation.
 FBIS—Foreign Broadcast Information Service.
 FSO—Foreign Service Officer.
 FYDP—Fiscal Year Defense Plan.
 GDIP—General Defense Intelligence Program.
 GRU—Soviet Military Intelligence Service.
 HUMINT—Human Intelligence.
 ICS—Intelligence Community Staff.
 INR—State Department's Bureau of Intelligence and Research.
 IRAC—Intelligence Resources Advisory Committee.
 IR&DC—Intelligence Research and Development Council.
 IRS—Internal Revenue Service.
 ISA—International Security Affairs, DOD.
 J-2—Joint Staff Director for Intelligence, DOD.
 JCS—Joint Chiefs of Staff.
 JRC—Joint Reconnaissance Center.
 JSOP—Joint Strategic Objectives Plan.
 KGB—Soviet National Intelligence Organization.
 KIQ—Key Intelligence Question.
 MBFR—Mutual and Balanced Force Reduction.
 NFIP—National Foreign Intelligence Program.
 NIA—National Intelligence Agency.
 NIB—National Intelligence Bulletin.
 NID—National Intelligence Daily.
 NIE—National Intelligence Estimate.
 NIO—National Intelligence Officer.
 NIS—Naval Investigative Service.
 NKVD—Predecessor to the the KGB.
 NPIC—National Photographic Interpretation Center.
 NSA—National Security Agency.
 NSA/CSS—National Security Agency/Central Security Service.
 NSAM—National Security Action Memorandum.
 NSC—National Security Council.
 NSCIC—National Security Council Intelligence Committee.
 NSCID—National Security Council Intelligence Directive.
 NSDM—National Security Decision Memorandum.
 NSSM—National Security Study Memorandum.
 OCB—Operations Coordinating Board.

OMB—Office of Management and Budget.
ONE—Office of National Estimates.
ONI—Office of Naval Intelligence.
OPC—Office of Policy Coordination.
OSD—Office of the Secretary of Defense.
OSO—Office of Special Operations, CIA.
OSO—Office of Special Operations, DOD.
OSS—Office of Strategic Services.
PCG—Planning and Coordination Group, NSC.
PFIAB—President's Foreign Intelligence Advisory Board.
PNIOs—Priority National Intelligence Objectives.
PSB—Psychological Strategy Board, NSC.
R.&D.—Research and Development.
R.D.T.&E.—Research, Development, Test & Evaluation.
SALT—Strategic Arms Limitation Talks.
SCAs—Service Cryptologic Agencies (collection)
SIGINT—Signals Intelligence.
SNIE—Special National Intelligence Estimate.
SOD—Special Operations Division, Fort Detrick, Maryland.
TELINT—Telemetry Intelligence.
TOA—Total Obligational Authority.
TSD—Technical Services Division, CIA.
USAINTA—United States Army Intelligence Agency.
USIB—United States Intelligence Board.
WSAG—Washington Special Action Group.

**Control and Direction of U.S. Foreign Intelligence
within the NATIONAL SECURITY COUNCIL System**
(After Executive Order 11905, February 18, 1976)

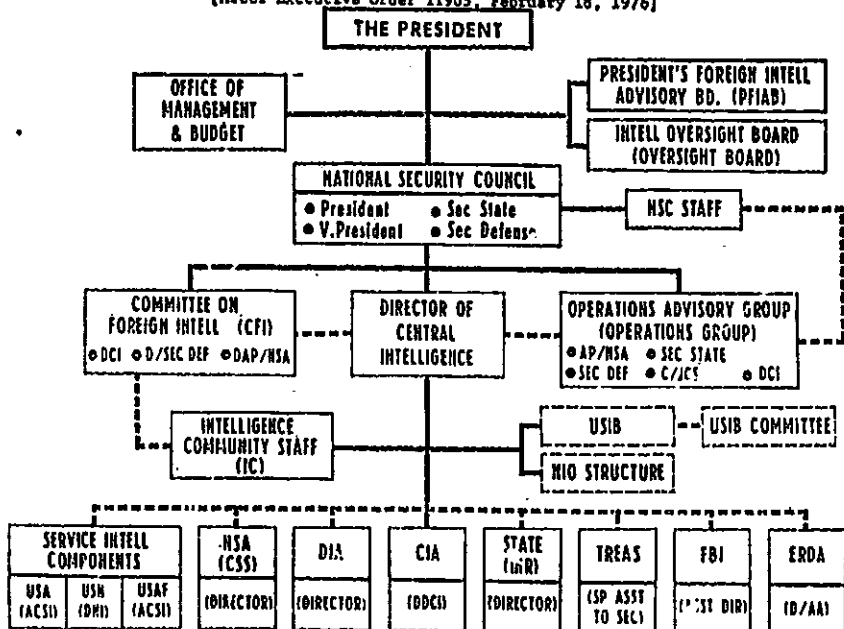

NATIONAL INTELLIGENCE COMMUNITY STRUCTURE

(Prior to Executive Order 11905, February 18, 1976)

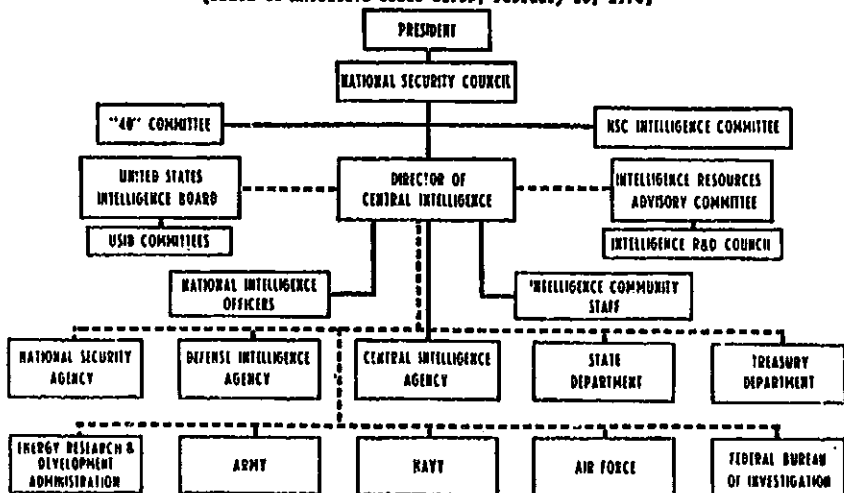

— DIRECTION
 - - - RECOMMENDATION/
 GUIDANCE/ADVICE

Intelligence Community Staff Organization
 (After Executive Order 11905, February 18, 1976)

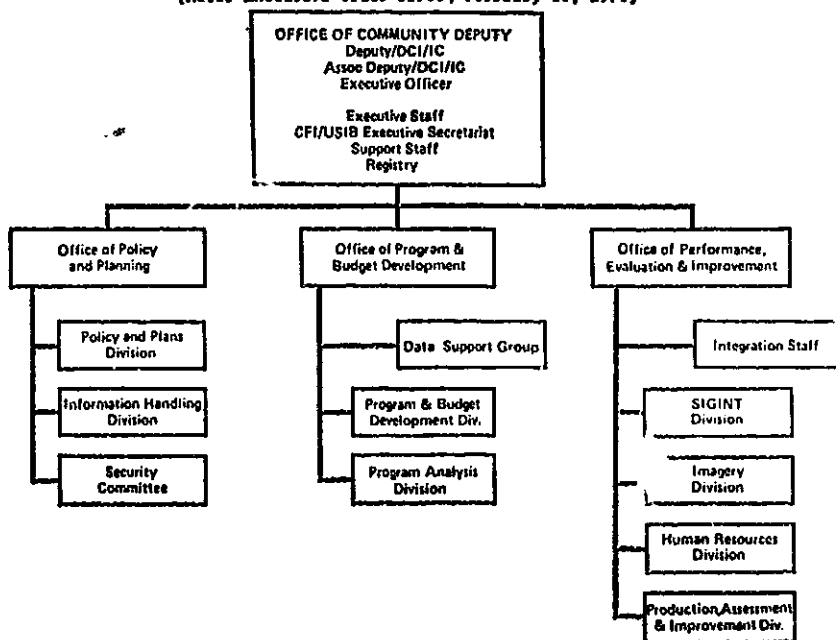

Intelligence Community Staff Organization

(Prior to Executive Order 11905, February 18, 1976)

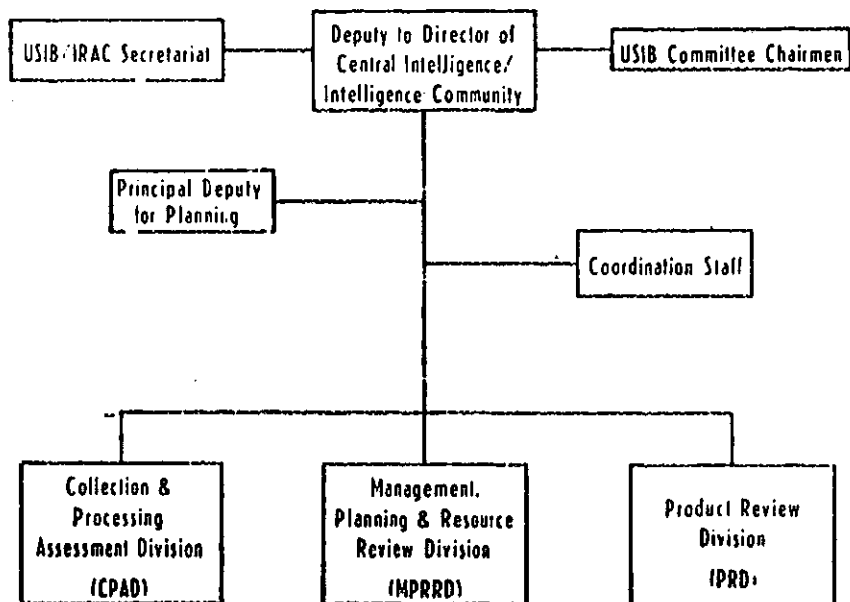

94TH CONGRESS
1ST SESSION

S. RES. 21

IN THE SENATE OF THE UNITED STATES

JANUARY 21, 1975

Mr. PASTORE submitted the following resolution; which was ordered to be placed on the calendar (under general orders)

JANUARY 27, 1975

Considered, amended, and agreed to

RESOLUTION

To establish a select committee of the Senate to conduct an investigation and study with respect to intelligence activities carried out by or on behalf of the Federal Government.

1 *Resolved*, To establish a select committee of the Senate
2 to conduct an investigation and study of governmental op-
3 erations with respect to intelligence activities and of the
4 extent, if any, to which illegal, improper, or unethical activ-
5 ities were engaged in by any agency of the Federal Govern-
6 ment or by any persons, acting individually or in combination
7 with others, with respect to any intelligence activity carried
8 out by or on behalf of the Federal Government; be it further

9 *Resolved*, That (a) there is hereby established a select
10 committee of the Senate which may be called, for con-

1 venience of expression, the Select Committee To Study
2 Governmental Operations With Respect to Intelligence Ac-
3 tivities to conduct an investigation and study of the extent, if
4 any, to which illegal, improper, or unethical activities were
5 engaged in by any agency or by any persons, acting either
6 individually or in combination with others, in carrying out
7 any intelligence or surveillance activities by or on behalf
8 of any agency of the Federal Government.

9 (b) The select committee created by this resolution
10 shall consist of eleven Members of the Senate, six to be
11 appointed by the President of the Senate from the majority
12 Members of the Senate upon the recommendation of the
13 majority leader of the Senate, and five minority Members of
14 the Senate to be appointed by the President of the Senate
15 upon the recommendation of the minority leader of the
16 Senate. For the purposes of paragraph 6 of rule XXV of the
17 Standing Rules of the Senate, service of a Senator as a
18 member, chairman, or vice chairman of the select committee
19 shall not be taken into account.

20 (c) The majority members of the committee shall select
21 a chairman and the minority members shall select a vice
22 chairman and the committee shall adopt rules and procedures
23 to govern its proceedings. The vice chairman shall preside
24 over meetings of the select committee during the absence
25 of the chairman, and discharge such other responsibilities

1 as may be assigned to him by the select committee or the
2 chairman. Vacancies in the membership of the select com-
3 mittee shall not affect the authority of the remaining mem-
4 bers to execute the functions of the select committee and
5 shall be filled in the same manner as original appointments
6 to it are made.

7 (d) A majority of the members of the select committee
8 shall constitute a quorum for the transaction of business, but
9 the select committee may affix a lesser number as a quorum
10 for the purpose of taking testimony or depositions.

11 SEC. 2. The select committee is authorized and directed
12 to do everything necessary or appropriate to make the in-
13 vestigations and study specified in subsection (a) of the
14 first section. Without abridging in any way the authority
15 conferred upon the select committee by the preceding
16 sentence, the Senate further expressly authorizes and directs
17 the select committee to make a complete investigation and
18 study of the activities of any agency or of any and all persons
19 or groups of persons or organizations of any kind which
20 have any tendency to reveal the full facts with respect to
21 the following matters or questions:

22 (1) Whether the Central Intelligence Agency has
23 conducted an illegal domestic intelligence operation in
24 the United States.

1 (2) The conduct of domestic intelligence or coun-
2 terintelligence operations against United States citizens
3 by the Federal Bureau of Investigation or any other
4 Federal agency.

5 (3) The origin and disposition of the so-called Hus-
6 ton Plan to apply United States intelligence agency
7 capabilities against individuals or organizations within
8 the United States.

9 (4) The extent to which the Federal Bureau of In-
10 vestigation, the Central Intelligence Agency, and other
11 Federal law enforcement or intelligence agencies coordi-
12 nate their respective activities, any agreements which
13 govern that coordination, and the extent to which a lack
14 of coordination has contributed to activities or actions
15 which are illegal, improper, inefficient, unethical, or con-
16 trary to the intent of Congress.

17 (5) The extent to which the operation of domestic
18 intelligence or counterintelligence activities and the
19 operation of any other activities within the United States
20 by the Central Intelligence Agency conforms to the leg-
21 islative charter of that Agency and the intent of the
22 Congress.

23 (6) The past and present interpretation by the
24 Director of Central Intelligence of the responsibility to
25 protect intelligence sources and methods as it relates to

1 the provision in section 102 (d) (3) of the National
2 Security Act of 1947 (50 U.S.C. 403 (d) (3)) that
3 "... that the agency shall have no police, subpoena, law
4 enforcement powers, or internal security functions. . . ."

5 (7) Nature and extent of executive branch over-
6 sight of all United States intelligence activities.

7 (8) The need for specific legislative authority to
8 govern the operations of any intelligence agencies of
9 the Federal Government now existing without that
10 explicit statutory authority, including but not limited to
11 agencies such as the Defense Intelligence Agency and
12 the National Security Agency.

13 The nature and extent to which Federal agencies
14 cooperate and exchange intelligence information and
15 the adequacy of any regulations or statutes which
16 govern such cooperation and exchange of intelligence
17 information.

18 (9) The extent to which United States intelligence
19 agencies are governed by Executive orders, rules, or
20 regulations either published or secret and the extent
21 to which those Executive orders, rules, or regulations
22 interpret, expand, or are in conflict with specific legis-
23 lative authority.

24 (10) The violation or suspected violation of any
25 State or Federal statute by any intelligence agency or

6

1 by any person by or on behalf of any intelligence agency
2 of the Federal Government including but not limited
3 to surreptitious entries, surveillance, wiretaps, or eaves-
4 dropping, illegal opening of the United States mail, or
5 the monitoring of the United States mail.

6 (11) The need for improved, strengthened, or con-
7 solidated oversight of United States intelligence ac-
8 tivities by the Congress.

9 (12) Whether any of the existing laws of the
10 United States are inadequate, either in their provisions
11 or manner of enforcement, to safeguard the rights of
12 American citizens, to improve executive and legislative
13 control of intelligence and related activities, and to re-
14 solve uncertainties as to the authority of United States
15 intelligence and related agencies.

16 (13) Whether there is unnecessary duplication of
17 expenditure and effort in the collection and processing
18 of intelligence information by United States agencies.

19 (14) The extent and necessity of overt and covert
20 intelligence activities in the United States and abroad.

21 (15) Such other related matters as the committee
22 deems necessary in order to carry out its responsibilities
23 under section (a).

24 SEC. 3. (a) To enable the select committee to make
25 the investigation and study authorized and directed by this

1 resolution, the Senate hereby empowers the select committee
2 as an agency of the Senate (1) to employ and fix the com-
3 pensation of such clerical, investigatory, legal, technical,
4 and other assistants as it deems necessary or appropriate,
5 but it may not exceed the normal Senate salary schedules;
6 (2) to sit and act at any time or place during sessions,
7 recesses, and adjournment periods of the Senate; (3) to hold
8 hearings for taking testimony on oath or to receive docu-
9 mentary or physical evidence relating to the matters and
10 questions it is authorized to investigate or study; (4) to
11 require by subpoena or otherwise the attendance as witnesses
12 of any persons who the select committee believes have
13 knowledge or information concerning any of the matters
14 or questions it is authorized to investigate and study; (5)
15 to require by subpoena or order any department, agency,
16 officer, or employee of the executive branch of the United
17 States Government, or any private person, firm, or corpora-
18 tion, to produce for its consideration or for use as evidence
19 in its investigation and study any books, checks, canceled
20 checks, correspondence, communications, document, papers,
21 physical evidence, records, recordings, tapes, or materials re-
22 lating to any of the matters or questions it is authorized to
23 investigate and study which they or any of them may have
24 in their custody or under their control; (6) to make to the
25 Senate any recommendations it deems appropriate in respect

1 to the willful failure or refusal of any person to answer ques-
2 tions or give testimony in his character as a witness during
3 his appearance before it or in respect to the willful failure
4 or refusal of any officer or employee of the executive branch
5 of the United States Government or any person, firm, or
6 corporation to produce before the committee any books,
7 checks, canceled checks, correspondence, communications,
8 document, financial records, papers, physical evidence,
9 records, recordings, tapes, or materials in obedience to any
10 subpoena or order; (7) to take depositions and other testi-
11 mony on oath anywhere within the United States or in any
12 other country; (8) to procure the temporary or intermit-
13 tent services of individual consultants, or organizations there-
14 of, in the same manner and under the same conditions as
15 a standing committee of the Senate may procure such serv-
16 ices under section 202 (i) of the Legislative Reorganiza-
17 tion Act of 1946; (9) to use on a reimbursable basis, with
18 the prior consent of the Committee on Rules and Adminis-
19 tration, the services of personnel of any such department
20 or agency; (10) to use on a reimbursable basis or other-
21 wise with the prior consent of the chairman of any sub-
22 committee of any committee of the Senate the facilities or
23 services of any members of the staffs of such other Senate
24 committees or any subcommittees of such other Senate com-
25 mittees whenever the select committee or its chairman deems

1 that such action is necessary or appropriate to enable the
2 select committee to make the investigation and study author-
3 ized and directed by this resolution; (11) to have direct
4 access through the agency of any members of the select
5 committee or any of its investigatory or legal assistants
6 designated by it or its chairman or the ranking minority
7 member to any data, evidence, information, report, analysis,
8 or document or papers, relating to any of the matters or
9 questions which it is authorized and directed to investigate
10 and study in the custody or under the control of any depart-
11 ment, agency, officer, or employee of the executive branch
12 of the United States Government, including any department,
13 agency, officer, or employee of the United States Govern-
14 ment having the power under the laws of the United States
15 to investigate any alleged criminal activities or to prosecute
16 persons charged with crimes against the United States and
17 any department, agency, officer, or employee of the United
18 States Government having the authority to conduct intelli-
19 gence or surveillance within or outside the United States,
20 without regard to the jurisdiction or authority of any other
21 Senate committee, which will aid the select committee to
22 prepare for or conduct the investigation and study authorized
23 and directed by this resolution; and (12) to expend to the
24 extent it determines necessary or appropriate any moneys

1 made available to it by the Senate to perform the duties
2 and exercise the powers conferred upon it by this resolution
3 and to make the investigation and study it is authorized by
4 this resolution to make.

5 (b) Subpenas may be issued by the select committee
6 acting through the chairman or any other member designated
7 by him, and may be served by any person designated by
8 such chairman or other member anywhere within the borders
9 of the United States. The chairman of the select committee,
10 or any other member thereof, is hereby authorized to admin-
11 ister oaths to any witnesses appearing before the committee.

12 (c) In preparing for or conducting the investigation
13 and study authorized and directed by this resolution, the
14 select committee shall be empowered to exercise the powers
15 conferred upon committees of the Senate by section 6002 of
16 title 18, United States Code, or any other Act of Congress
17 regulating the granting of immunity to witnesses.

18 **SEC. 4.** The select committee shall have authority to
19 recommend the enactment of any new legislation or the
20 amendment of any existing statute which it considers neces-
21 sary or desirable to strengthen or clarify the national secu-
22 rity, intelligence, or surveillance activities of the United
23 States and to protect the rights of United States citizens
24 with regard to those activities.

1 **SEC. 5.** The select committee shall make a final report
2 of the results of the investigation and study conducted by
3 it pursuant to this resolution, together with its findings and
4 its recommendations as to new congressional legislation it
5 deems necessary or desirable, to the Senate at the earliest
6 practicable date, but no later than September 1, 1975. The
7 select committee may also submit to the Senate such interim
8 reports as it considers appropriate. After submission of its
9 final report, the select committee shall have three calendar
10 months to close its affairs, and on the expiration of such
11 three calendar months shall cease to exist.

12 **SEC. 6.** The expenses of the select committee through
13 September 1, 1975, under this resolution shall not exceed
14 \$750,000 of which amount not to exceed \$100,000 shall be
15 available for the procurement of the services of individual
16 consultants or organizations thereof. Such expenses shall be
17 paid from the contingent fund of the Senate upon vouchers
18 approved by the chairman of the select committee.

19 **SEC. 7.** The select committee shall institute and carry
20 out such rules and procedures as it may deem necessary to
21 prevent (1) the disclosure, outside the select committee, of
22 any information relating to the activities of the Central In-
23 telligence Agency or any other department or agency of the
24 Federal Government engaged in intelligence activities, ob-

1 tained by the select committee during the course of its study
and investigation, not authorized by the select committee
3 to be disclosed; and (2) the disclosure, outside the select
4 committee, of any information which would adversely affect
5 the intelligence activities of the Central Intelligence Agency
6 in foreign countries or the intelligence activities in foreign
7 countries of any other department or agency of the Federal
8 Government.

9 SEC. 8. As a condition for employment as described in
10 section 3 of this resolution, each person shall agree not to
11 accept any honorarium, royalty or other payment for a
12 speaking engagement, magazine article, book, or other en-
13 deavor connected with the investigation and study under-
14 taken by this committee.

15 SEC. 9. No employee of the select committee or any
16 person engaged by contract or otherwise to perform services
17 for the select committee shall be given access to any classi-
18 fied information by the select committee unless such em-
19 ployee or person has received an appropriate security clear-
20 ance as determined by the select committee. The type of
21 security clearance to be required in the case of any such
22 employee or person shall, within the determination of the
23 select committee, be commensurate with the sensitivity of
24 the classified information to which such employee or person
25 will be given access by the select committee.

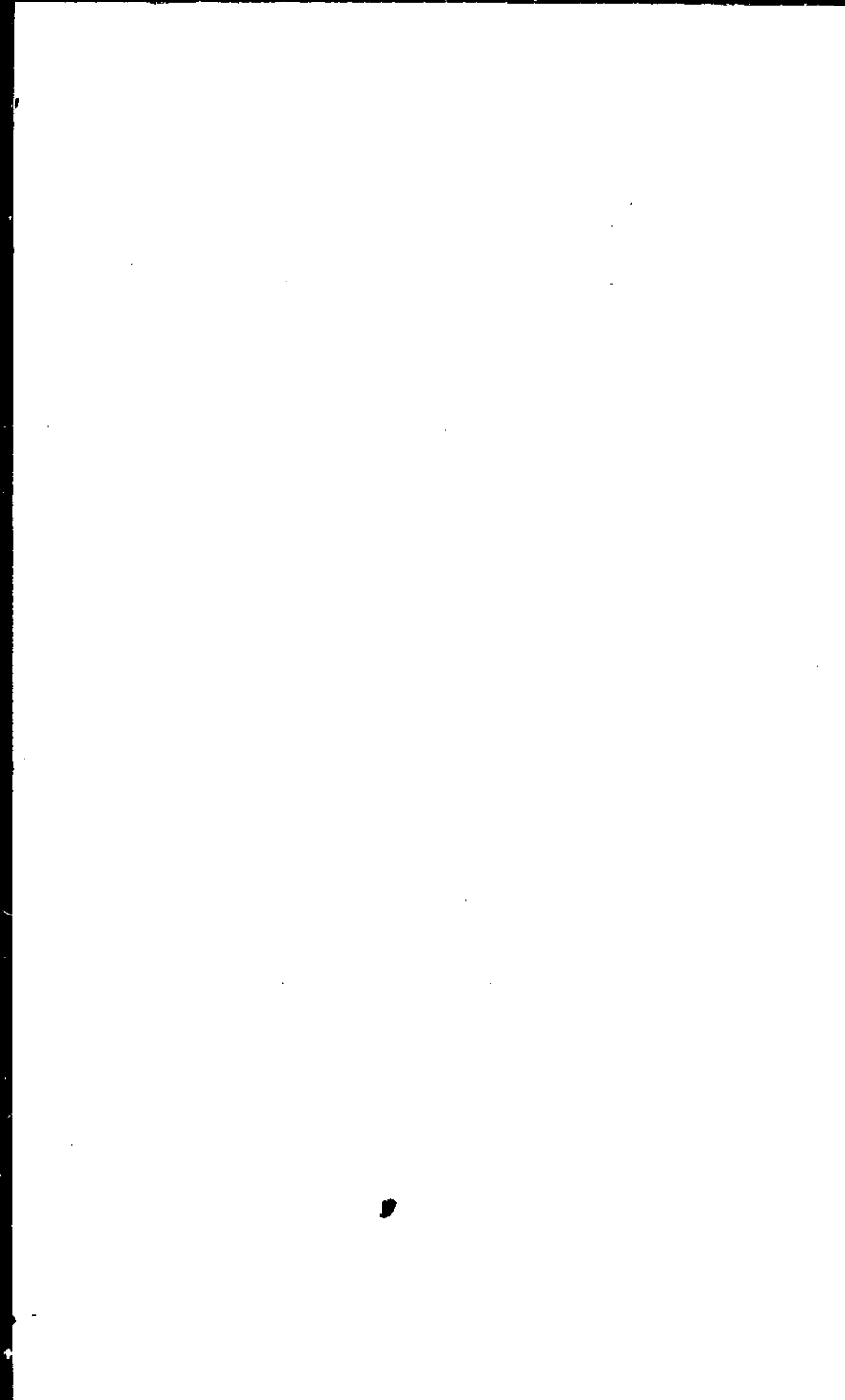

STAFF LIST

This Final Report is the result of a sustained effort by the entire Committee staff. The Committee wishes to express its appreciation to the members of the support, legal, research, and Task Force staffs, who made a substantial contribution to this Report and who have served the Committee and the Senate with integrity and loyalty:

David Aaron.....	Task Force Leader.
William Bader.....	Task Force Leader.
Barbara Banoff.....	Counsel.
Howard Barkey.....	Consultant.
Frederick Baron.....	Counsel.
Laurie Bartlet.....	Secretary.
Lawrence Baskir.....	Counsel.
John Bayly.....	Counsel.
Charity Benz.....	Office Manager.
Richard Betts.....	Professional Staff Member.
Beth Bloomfield.....	Research Assistant.
Sam Bouchard.....	Professional Staff Member.
Harriet Bramble.....	Secretary.
Belva Brissett.....	Secretary.
Nancy Brooks.....	Secretary.
Maxine Brown.....	Secretary.
Andrew Burness.....	Clerk.
David Bushong.....	Counsel.
Margaret Carpenter.....	Research Assistant.
Barry Carter.....	Counsel.
Barbara Chesnik.....	Research Assistant.
Lot Cooke.....	Clerk/Security.
Elizabeth Culbreth.....	Counsel.
Lynn Davis.....	Professional Staff Member.
Spencer Davis.....	Press Secretary.
Rhett Dawson.....	Counsel.
Tom Dawson.....	Research Assistant.
James De Marco.....	Counsel.
Joseph Dennin.....	Counsel.
Mary De Ore.....	Research Assistant.
Mary de Temple.....	Secretary.
James Dick.....	Counsel.
Joseph di Genova.....	Counsel.
Dorothy Dillon.....	Research Assistant.
Patricia Doolittle.....	Secretary.
Daniel Dwyer, Jr.....	Research Assistant.
Robert Edwards, Jr.....	Clerk/Security.
John Elliff.....	Task Force Leader.
Betty Ellison.....	Secretary.
Michael Epstein.....	Counsel.

Joan Erno	Secretary.
Peter Fenn	Professional Staff Member.
Harold Ford	Consultant.
Richard Garwin	Consultant.
Mark Gitenstein	Counsel.
Janette Glidewell	Secretary.
Bruce Grant	Counsel.
Edward Greissing	Research Assistant.
Arthur Harrigan	Consultant.
William Harris	Consultant.
Audrey Hatry	Clerk of the Committee.
Deborah Herbst	Assistant Press Secretary.
Paulette Hodges	Secretary.
Karl Inderfurth	Professional Staff Member.
Portia Iverson	Secretary.
Arthur Jefferson	Counsel.
Dorothy Johnson	Secretary.
Loch Johnson	Professional Staff Member.
Yolanda Johnson	Clerk.
James Johnston	Counsel.
Anne Karalekas	Professional Staff Member.
Jeffrey Kayden	Research Assistant.
Robert Kelley	Counsel.
Lawrence Kieves	Control Coordinator.
Charles Kirbow	Counsel.
Joseph Kirchheimer	Consultant.
Diane Koppal	Secretary.
Susan Koscis	Secretary.
Diane LaVoy	Research Assistant.
George Lawton	Professional Staff Member.
Howard Liebengood	Consultant.
Charles Lombard	Professional Staff Member.
Dan McCorkle	Clerk/Security.
Dorothy McIntyre	Secretary.
Martha MacDonald	Secretary.
Naldeen MacDonald	Research Assistant.
Michael Madigan	Counsel.
Ben Marshall	Security Director.
Cynthia Mascioli	Secretary.
Judith Mason	Research Assistant.
Ernest May	Consultant.
Betty Mayo	Secretary.
Elliott Maxwell	Counsel.
Ellen Metsky	Clerk.
Paul Michel	Counsel.
William Miller	Staff Director.
Patricia Monaco	Secretary.
Janet Moore	Secretary.
Michael Murphy	Clerk/Security Assistant.
Lois Nuss	Secretary.
James O'Flaherty	Professional Staff Member.
Jan Orloff	Research Director.
Lynsey Oster	Clerk.

Drena Owens	Secretary.
John Peterson	Research Director.
Susan Pitts	Research Assistant.
Andrew Postal	Counsel.
Christopher Pyle	Consultant
Alton Quanbeck	Task Force Leader.
Ted Ralston	Research Assistant.
Harry Ransom	Consultant.
Gordon Rhea	Counsel.
Eric Richard	Counsel.
Walter Ricks III	Counsel.
Alan Romberg	Professional Staff Member.
James Rowe	Research Assistant.
Ruth Schneider	Secretary.
Frederick A. O. Schwarz, Jr.	Chief Counsel.
Paula Schwartz	Clerk.
Lester Seidel	Counsel.
Patrick Shea	Professional Staff Member.
John L. Smith	Counsel.
Elizabeth Smith	Research Assistant.
Stephanie Smith	Clerk.
Curtis Smothers	Counsel for Minority.
Britt Snider	Counsel.
Martha Talley	Counsel.
Athan Theoharis	Consultant
Florence Thoben	Mail Clerk.
Sherry Towell	Office Manager.
Gregory Treverton	Professional Staff Member.
William Truehart	Consultant.
James Tschirgi	Professional Staff Member.
James Turner	Research Assistant.
Richard Ullman	Consultant.
Paul Wallach	Counsel.
William White	Professional Staff Member.
Burton Wides	Counsel.
Carol Wiik	Document Clerk.
Joan Wilson	Secretary.
Otis Wilson	Consultant.
Peter Zimmerman	Consultant.
Phebe Zimmerman	Research Assistant.

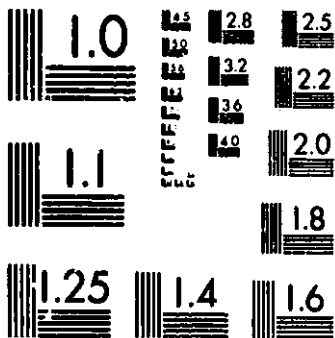

MICROCOPY RESOLUTION TEST CHART
 NATIONAL BUREAU OF STANDARDS-1963-A

2011