

# The bungalows of Buffalo

---

F Downing

Department of Architecture, State University of New York at Buffalo, Buffalo, NY 14214, USA

U Flemming

Department of Architecture, Carnegie-Mellon University, Pittsburgh, PA 15213, USA

Received 13 November 1981

---

**Abstract.** Measured drawings of seven bungalows that were built between 1914 and 1926 in Buffalo, New York, are presented. The paper concentrates on the conventions which govern the organization of spaces in these bungalows and establish linkages with other house types in the popular tradition. The conventions found are expressed through the schemata of a parametric shape grammar which allow differences between bungalows to be explained as different geometric realizations of a shared set of conventions.

## 1 Introduction

In the United States, the term *bungalow* initially referred to small vacation houses or summer retreats located in the countryside or at beaches. These bungalows were free-standing, one-storied, wooden structures, often supported by piers, enclosed by thin walls without insulation, and covered by a large roof. Their plans were loosely ordered; they included porches, verandahs, or bays, which gave them an irregular contour. These structures were clearly temporary in nature and not intended for permanent use.

At the beginning of this century, the meaning of the term changed. Many of the permanently occupied houses built in newly developed suburbs around the perimeter of cities were now called bungalows, probably because they shared with their predecessors certain features: they were free-standing, but of modest appearance; furthermore, they were covered by a large roof and appeared to be one-storey high, although the space underneath the roof was often used to accommodate additional rooms.

During this time, conventions or principles became established which regulated not only the external appearance of these bungalows, but also their internal organization, that is, the types of spaces contained in them as well as the shape and placement of these spaces relative to each other or the outside. In this form, bungalows represent one of the first common house types to break regional boundaries and to gain national popularity in the first and second decades of this century. Pattern books such as Saylor (1911), Hodgson (1912), and Yoho (1914) or the articles published by Stickley in *Craftsman Homes* and *More Craftsman Homes* (a selection of which is reprinted in Stickley, 1979) contributed strongly both to the popularization and to the standardization of the type [see Downing (1982) for a more detailed account of these developments].

Our paper presents drawings of a small sample of houses from early suburban developments in Buffalo, New York. The size, height, and appearance of these houses make them readily identifiable as bungalows. The paper, however, does not deal with these obvious similarities; rather, it concentrates on their spatial organization as given through the plans of their first floors. It shows that these plans reflect a limited set of rather rigid conventions and that major differences in their design can be explained as *different geometric realizations of the same set of conventions*. To demonstrate

this result, we develop a parametric shape grammar which generates the plans of the bungalows in our sample. The selected formalism proved particularly suitable for our purpose since the schemata in such grammars make it possible to describe simultaneously the design conventions found and the ways in which they can be geometrically realized [readers who are not familiar with the notation and terminology used are referred to Stiny (1980)].

The plans of the first floors also determine (to a certain degree) the plans of the upper floors as well as the elevations of the given buildings. A complete analysis would, of course, have to account also for those features which are not determined by the plans of the first floors, and the formalism used could be extended to include these features. We restricted the scope of the paper, however, to an analysis of the first floors not only because the underlying conventions were particularly easy to discover and explain from our own experience both as users and as designers of houses or apartments; more importantly, we were interested in laying the groundwork for an analysis of common house types which would transcend a crude division into 'styles' (for example post-colonial, post-Victorian, late shingle, bungalow) and allow for a more subtle analysis of types and their evolution over time. For this purpose, the conventions governing the spatial organization of bungalows appear particularly interesting since they establish linkages between the types and styles of the time (some of which are still in use today). A second paper (Flemming, 1981b) will show how the 'constructive descriptions' given through our shape grammar can be used to arrive at precise indicators of the similarities and differences between the bungalows in our sample, a methodology that can be extended without difficulty to a larger and more diverse corpus of houses.

This goal should be kept in mind while reading the paper: in developing our grammar, we were not interested in a formalism which would generate the plans in our sample in the simplest way. We attempted instead to present the nucleus of a more general grammar which could be expanded (through additional schemata or a generalization of the schemata contained in it) to generate a diverse language of common houses.

Finally, we would like to stress that our paper can also be read as a demonstration of the generality of the shape grammar formalism: it presents, as far as we know, a first application to buildings in the popular tradition.

## 2 Our sample

At the present time, there are available to us measured drawings of seven houses which we consider bungalows. This sample was selected from two streets in separate neighborhoods whose housing stock consists largely of bungalows. The configurations of lots and buildings along the two streets are shown in figures 1(a) and 1(b); figures 1(c) and 1(d) give partial views of the streets. Street 1 runs from north to south, whereas street 2 runs almost exactly from east to west (the street names as well as the addresses of the measured buildings had to be withheld upon the request of some owners). Five houses were measured in street 1; they are labelled from A to E in figure 1(a). In street 2, two houses were measured, which are labelled F and G in figure 1(b). For each of the measured buildings, figure 2 shows one side elevation, the front (or street) elevation, and the plan of the first (or ground) floor.

It is difficult to establish the exact construction dates for the houses under consideration. A good approximation, though, are the years in which the building permits were granted by the City of Buffalo:

A	B	C	D	E	F	G
1915	1914	1918	1915	1919	1926	1924

The houses were apparently built in the second and third decades of this century.

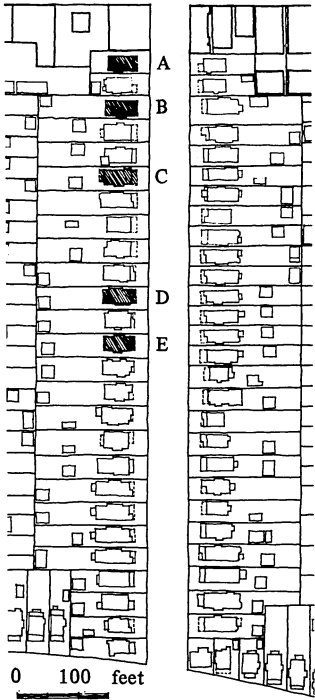

(a) Street 1

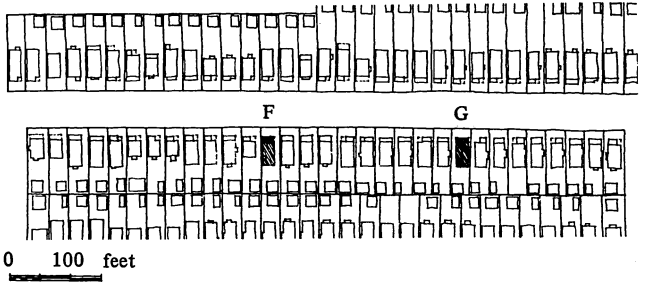

(b) Street 2



(c) Partial view of street 1



(d) Partial view of street 2

Figure 1. The siting of bungalows A-G.

Figure 2 depicts the conditions in which the houses were found in 1979, when they were measured. Some obvious additions, such as awnings or aluminum storm-windows, which would obstruct certain portions of the elevations, were omitted in the drawings shown. But no systematic attempts were made to reconstruct the original states. No problems seem to result for the present paper: it deals exclusively with the plans of the first floors which seem to have remained largely unchanged (as an inspection of the interior woodwork suggests).



east elevation



north elevation

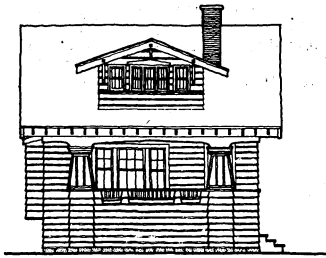

east elevation



north elevation

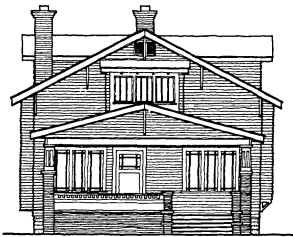

east elevation

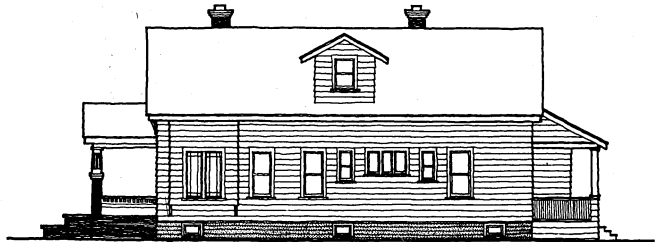

north elevation



east elevation



south elevation

Figure 2. The face and a side elevation and the plan of the first floor of bungalows A-G of figure 1.

Each bungalow contains on its first floor a living room, a dining room, a kitchen, and a staircase leading both to the basement and to the upper floor. Houses B to G contain also two bedrooms and a full bathroom on their first floors (these spaces are located on the second floor in house A). To these rooms are added in each plan ancillary spaces, such as storage areas or halls, in various combinations. Spaces are identified by the grammar through simple letter symbols; the meaning of the symbols used is given in table 1.

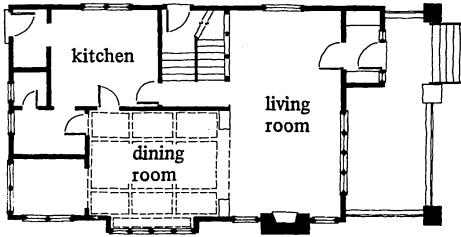

0 8 feet

bungalow A

plan of first floor

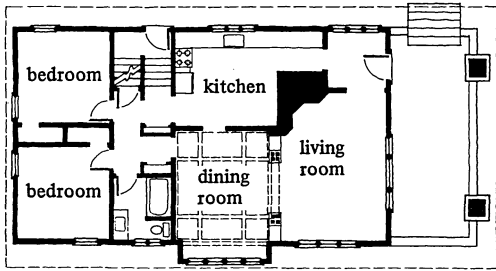

bungalow B

plan of first floor

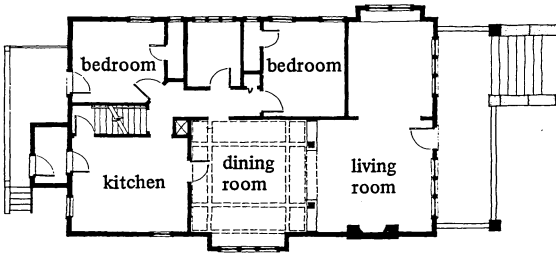

bungalow C

plan of first floor

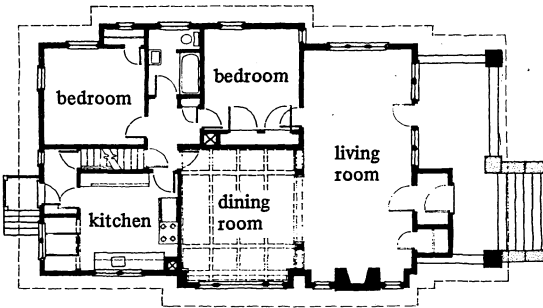

bungalow D

plan of first floor

We call living rooms, dining rooms, kitchens, and bedrooms *primary* spaces to distinguish them from all other spaces, which we call *secondary*. The distinction was introduced initially for technical reasons: the grammar was particularly easy to formulate after we made the decision that it should allocate the primary spaces first and determine the location of the secondary spaces later. This might, of course, point to a deeper reason for the distinction: the primary spaces are more important as they are larger and occupied over longer periods of time.

The conventions that govern the arrangement of spaces on the first floors reflect three broad classes of requirements:

- (1) *Functional requirements* which determine the nature and size of the spaces in a plan as well as certain connectivity relations between pairs of spaces or a space and the outside.
- (2) *Context requirements* imposed on the plans by the long and narrow shape of the lots, which face the street along their smaller side. The street, in turn, orients the buildings: it gives them a 'front' and a 'rear', and all plans respond to this orientation according to well-defined conventions. To facilitate the reader's understanding of these conventions, the plans in figure 2 are always drawn so that they face the street

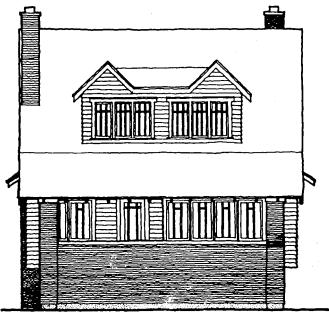

east elevation

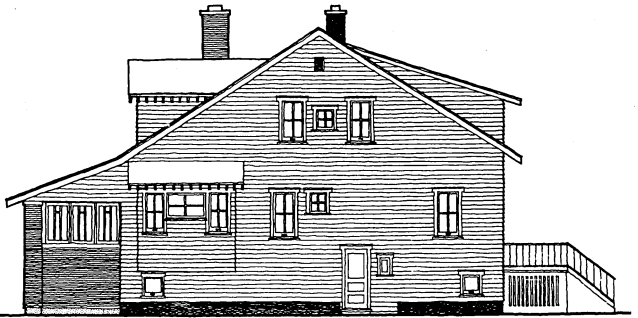

north elevation

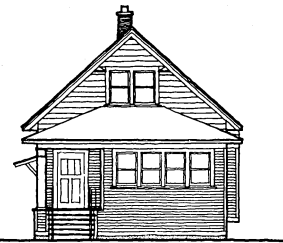

north elevation

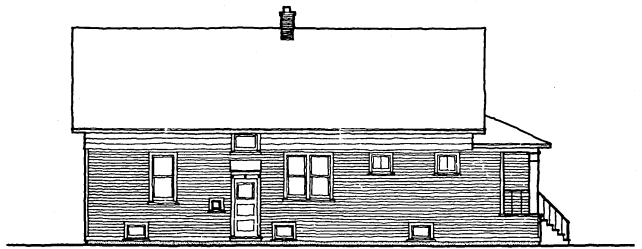

east elevation



north elevation

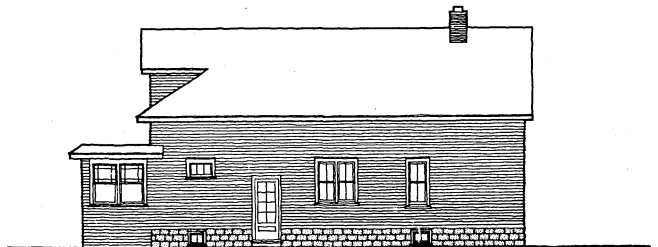

west elevation

Figure 2 (continued)

from the same direction, namely the left, which preserves the compass orientation for the majority of cases; only houses F and G were turned clockwise by approximately 90° from the positions shown in figure 1(b).

(3) *Formal requirements* or aesthetic conventions reflecting some seemingly strong notions of 'good shape' which will be explained below.

The schemata of the grammar describe how these conventions can be reconciled with each other in a bungalow plan. The language of plans generated by the grammar will be denoted by the symbol  $\Lambda$ .

**Table 1.** Symbols used to identify spaces.

Symbol	Meaning	Symbol	Meaning
b	bedroom	m	additional small living space
c	closet or other small ancillary space	n, o, p	open porches of various types
d	dining room	q	enclosed porch
h	hall	s	staircase
k	kitchen	t	bathroom
l	living room	v	vestibule

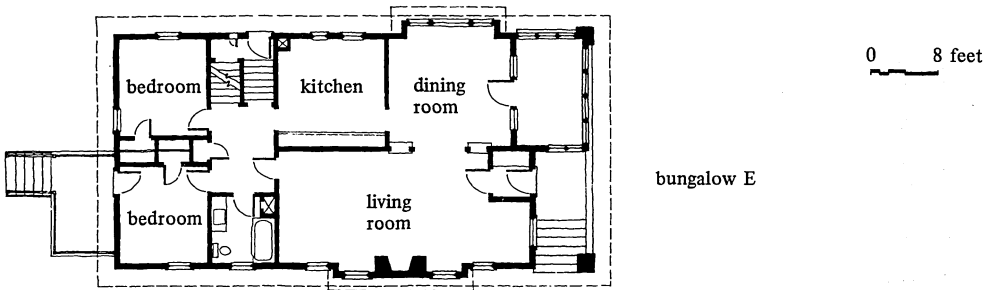

plan of first floor

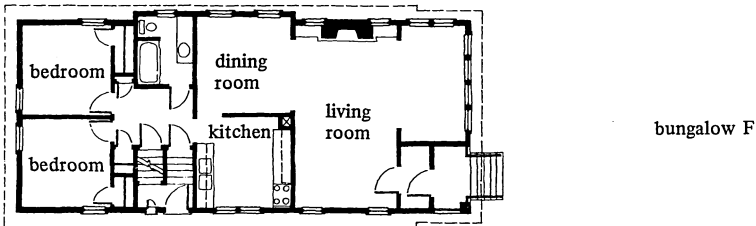

plan of first floor

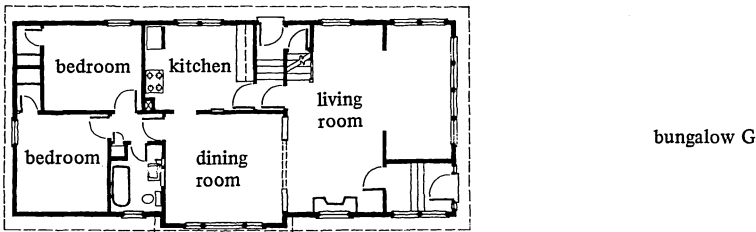

plan of first floor

### 3 The first part of the grammar: allocation of spaces

Almost all schemata of the grammar are fully parameterized; that is, the coordinates of each endpoint of a maximal line in a schema are variables. Assignments of values to these variables must preserve alignments of points parallel to the coordinate axes as given by the graphic specifications of the schemata. Additional constraints can be imposed on certain assignments through functional or context requirements; the less obvious cases will be described in connection with the schemata to which they apply.

The initial shape is given by the labelled shape

$$I = \langle S_\phi, \{(0, 0):K, (0, 0):l\} \rangle,$$

which contains two points, labelled K and l, but no lines; the coordinates of the labelled points are those of the origin. Point K is used in stage 1 to orient the plans generated by the grammar; point l is used to control the allocation of spaces in stage 2.

#### Stage 1: generation of a starting pattern

All shape grammars that are known to us and deal with the generation of architectural plans create, in a first stage, a geometric pattern which determines certain global characteristics of the plans and guides, possibly, also the development of some of their local properties. The generation of a Palladian plan, for example, starts with the production of a tartan grid which determines the possible locations of internal or external walls (Stiny and Mitchell, 1978). The design of a facade in the style of Terragni's Casa Giuliani Frigerio is governed throughout by the rhythm established through four rows of columns generated at the start of the process (Flemming, 1981a). A similar approach proved useful also for the present context. The schemata which generate starting patterns for bungalow plans are shown in figure 3.

The overall impression given by a house in our sample is that of a rectangular box covered by a large, pitched roof. A pattern book explains this form as follows:

"In the East even the cheapest house, except when it is occupied only for a couple of months in the summer time, requires a cellar and a comparatively substantial foundation and as this foundation is one of the chief sources of expense the tendency is to make it cover as small an area as possible and to build over it a comparatively high square box of a house. The necessity also of providing a roof with a slope sharp enough to shed the snow readily tends to make our cheaper Eastern and Middle Western house a stiff, angular little building, which is rather perched upon the site than fitted tightly to it" (Hodgson, 1912, page 5).

Schema 1 defines the external walls that form the enclosure for this type of structure; the lines with endpoints f and r mark, respectively, its front and rear (with respect to the street). The schema also generates an internal, load-bearing wall which divides the enclosed area into two parallel zones.

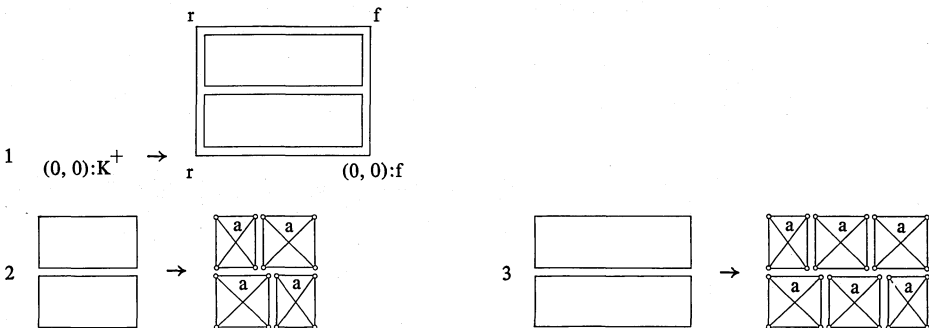

Figure 3. Schemata to generate a starting pattern.



Throughout the paper, the term *width* is used to refer to dimensions measured parallel to the front or rear of a plan, whereas the term *length* is used to refer to dimensions measured perpendicular to this direction. For graphical reasons, the thickness of all walls is unified and slightly exaggerated in most figures.

For the generation of the plans in our sample, the position of all walls and, consequently, the assignment of values to the variables in the right-hand side of schema 1 are given. But the grammar can also be used to generate a new plan in the bungalow tradition, possibly for a given site. In this case, the assignment of values must assure that (a) the gross area of the plan is appropriate (notice that for a given construction technology, building type, and level of comfort, this area is a rather good cost indicator and widely used by developers); (b) the plan fits the site; and (c) the widths of the zones are appropriate. To show the range within which the assignment of values can vary, table 2 lists the external dimensions of the given plans as well as the clear width of the two zones contained in them. Generally, zones in plans that are to contain bedrooms must be long enough to accommodate a row of three primary spaces and either a staircase or a bathroom, while zones in smaller plans must be long enough to accommodate a row of two primary spaces and a staircase. Porches are not included in these measures and will be added at a later stage. The width of a zone cannot exceed spans common for wooden joists.

If a plan is to be drawn on a site in the proper compass orientation, the origin must be placed in an appropriate position on that site, and schema 1 must be applied under an appropriate transformation  $\tau$ .

Nonbearing partitions are created by schemata 2 and 3, which divide the zones generated by schema 1 into two and three cells, respectively. The partitions can, but do not have to, be aligned across zones. The center point of each cell receives the label *a*. In addition, labels  $\circ$  are attached to the corners of the cells, and diagonals are drawn across their interior; these lines are needed in later stages and will be removed, together with the labels  $\circ$ , at the end of the generation process.

The shapes generated by schemata 1 to 3 are called *starting patterns*. A starting pattern,  $C_1$ , from which the plan of bungalow C can be produced is shown in figure 4.

Table 2. Some dimensions of the bungalows in our sample.

Bungalow	Overall length (excluding porch)	Overall width (excluding bays)	Clear width of upper zone	Clear width of lower zone
A	39'6"	24'9"	12'0"	11'0"
B	44'0"	24'6"	12'0"	11'0"
C	44'0"	26'0"	13'6"	11'4"
D	44'6"	26'3"	13'6"	10'6"
E	47'0"	27'0"	12'6"	12'3"
F	45'0"	23'3"	10'0"	10'6"
G	44'0"	22'6"	11'0"	9'10"

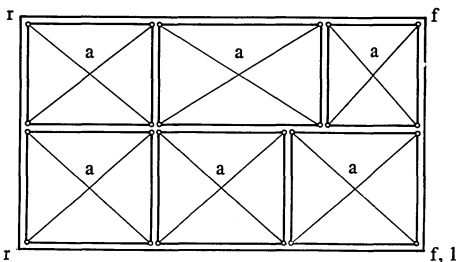

Figure 4. Starting pattern  $C_1$  for the generation of plan C.

This plan constitutes one of the more complicated cases in our sample and is used in this and the following sections to illustrate the workings of the grammar.

*Stage 2: allocation of primary spaces*

In all plans, living room, dining room, and kitchen form a cluster of public spaces, and the bedrooms form, together with some secondary spaces, an additional cluster of more private spaces so that the spaces in each cluster are related to each other or to the outside in a well-defined way; the schemata in figure 5 allocate the primary spaces in each cluster accordingly.

Schemata 4 to 7 allocate primary spaces in the cells of a starting pattern by substituting the appropriate space labels for the labels *a*. The left-hand sides of schemata 4 and 5 specify two cells which are adjacent to each other along an internal wall. The right-hand corners of the two cells must be vertically aligned, whereas the left-hand corners can, but do not have to, be aligned; furthermore, the left-hand corners of the upper cell can be to the left or right of the left-hand corners of the lower cell (in the orientation given in figure 5). The left-hand sides of schemata 6 and 7 represent the general case of two adjacent cells without specifying any particular alignments. The same conditions are implied by subsequent schemata which are specified in an analogous way; exceptions from this principle will be stated explicitly.

Schema 4 allocates living rooms in two adjacent cells, at least one of which must border the front of the plan; the two cells will be combined into a continuous living area at a later stage. Schema 5 places a dining room in a cell adjacent to a living room. The dining room must border the front of the plan if, after an application of schema 4, only one of the two cells in that position is used as a living room. Schema 6 allocates a kitchen in a cell adjacent to a dining room. These three schemata remove and attach labels to the origin in a way which assures that each of them must be applied exactly once in the generation of a plan in  $\Lambda$ . (Subsequent schemata use space labels in a similar way to enforce the application of certain schemata or to prevent repeated applications of the same schemata.) Schema 7, finally, allocates two bedrooms in two adjacent cells. This schema must be applied to remove all labels *a* from a starting pattern generated by schema 3. The form of schemata 4 to 6 assures that at least one bedroom must border the rear and that the kitchen can never face the front of a plan in  $\Lambda$ .

An example for the clusters of spaces generated by the schemata in figure 5 is given by shape  $C_2$  in figure 6, which is generated from shape  $C_1$  by applications of schemata 4 to 7.

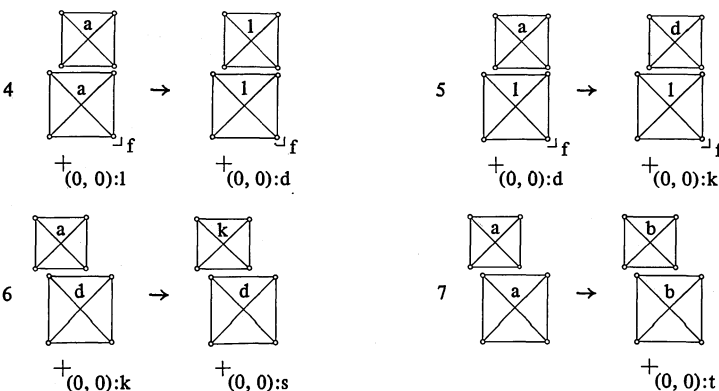

Figure 5. Schemata to allocate primary spaces.

The graphic representations of schemata 4 and 5 in figure 5 are similar except for the labels contained in them. Figure 7 shows how both schemata can be specified by the same drawing if *variable labels* are used. The symbols  $x, y,$  and  $z$  are employed frequently in subsequent figures to represent variable space labels, and the symbols  $p$  and  $q$  are used to represent variable labels marking external corners of a plan. These variables should be viewed as devices to shorten the list of schemata that must be specified explicitly (or alternatively as an extension of the shape grammar formalism).

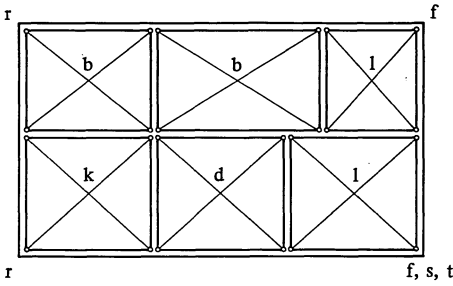
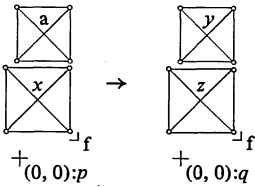

Figure 6. Shape  $C_2$  generated from shape  $C_1$  by applications of schemata 4 to 7.



either  $x = a, y = z = p = l,$  and  $q = d$   
 or  $x = z = l, y = p = d,$  and  $q = k$

Figure 7. Specification of schemata 4 and 5 through a single drawing by means of variable labels.

**Stage 3: addition of staircase, bathroom, and halls**

All bathrooms and staircases in our sample border an external wall, but are never allowed to face the front of the plan or to occupy one of its corners. The bathrooms, furthermore, are accessible only from an internal hall, which is also connected to the bedrooms and one other primary space; the hall thus acts as a buffer between the public and private spaces. Figure 8 shows the schemata that generate staircase, bathroom, and hall(s).

Schema 8 adds a staircase with one flight of stairs at the rear of a plan, whereas schema 9 adds a staircase with two flights of stairs at the side of a plan. The staircase is always placed between the kitchen and an adjacent space,  $x,$  which cannot

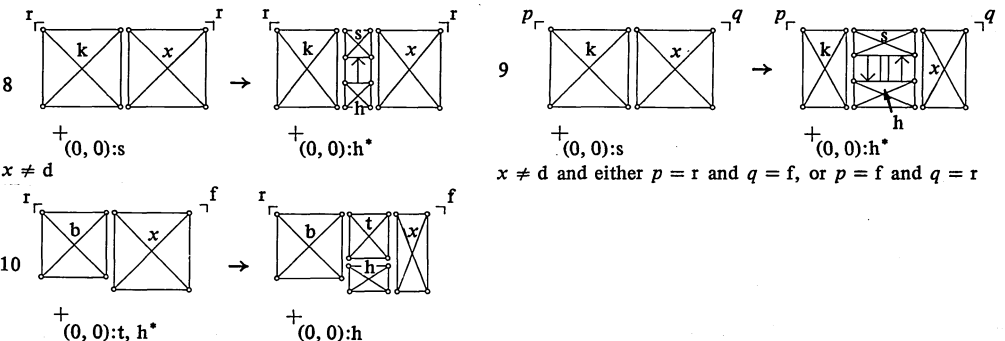

Figure 8. Schemata to allocate staircase, bathroom, and halls.

be a dining room. The size either of the kitchen, or of space  $x$ , or of both spaces is reduced by the operation. Flights of stairs are indicated by arrows pointing upwards. The area which makes the staircase accessible from the interior of the plan is marked as a hall.

Schema 10 places a bathroom between a bedroom and an adjacent space,  $x$ , at the side of a plan; it also generates a hall through which the bathroom can be reached from the surrounding spaces. The lower boundary of space  $x$  cannot be above the lower boundary of space  $b$ . An application of schema 10 can reduce the size of space  $b$  only if the lower boundaries of spaces  $x$  and  $b$  are aligned.

Shape  $C_3$  in figure 9 is generated from shape  $C_2$  by applications of schemata 8 and 10. Applications of the schemata in figure 8 can obviously generate two adjacent halls; these halls are merged into a single space in a later stage.

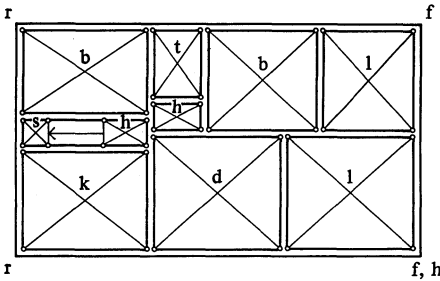

Figure 9. Shape  $C_3$  generated from shape  $C_2$  by applications of schemata 8 and 10.

*Stage 4: extension of spaces*

Among the most noticeable features of the bungalows in our sample are bays or projecting rooms which interrupt the rectangular enclosure of these houses. Most of the bays, at least, do not seem to be required for functional reasons as they do not increase the usable area to any significant degree. A possible explanation for these cases is given by Stickley, who is much in favor of "... pleasant nooks and corners which give a comfortable sense of semi-privacy and yet are not in any way shut off from the larger life of the room. Such an arrangement has always seemed to us symbolic of the ideal conditions of social life" (Stickley, 1979, page 236).

Bays and other projections occur only at the side of a plan and are never placed at one of its corners. Furthermore, the location of the dining room is always indicated from the outside through such an element. The schemata needed to generate all cases found in our sample are shown in figure 10.

Schema 11 places a bay at the side of a dining room or living room. Schema 12 creates a bay by extending a dining room along its entire length (see plan G). Schema 13 extends two spaces simultaneously along their entire lengths; one of these spaces must be a bathroom, and the other space can be either a dining room or

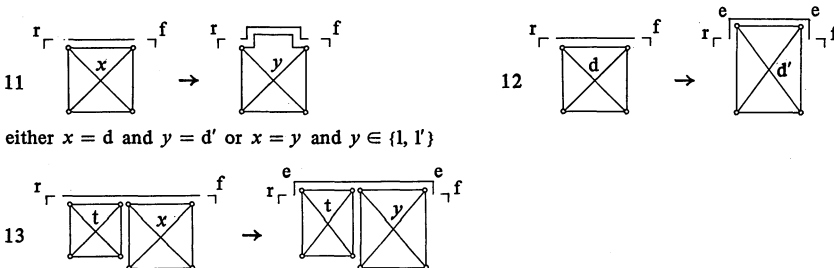

Figure 10. Schemata to extend spaces.

a bedroom (see plans D or F). External corners created by schemata 12 or 13 receive the label *e*, and a projecting dining room is marked by the label *d'*. Primes are used in a similar way by subsequent schemata to indicate the existence of certain required features.

Two applications of schema 11 are needed to add two bays to shape  $C_3$  and generate shape  $C_4$  shown in figure 11.

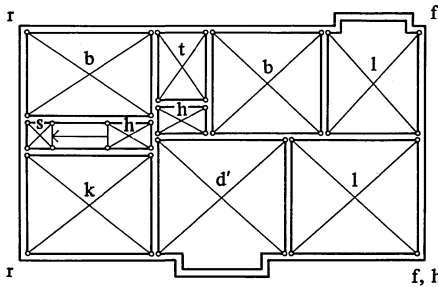
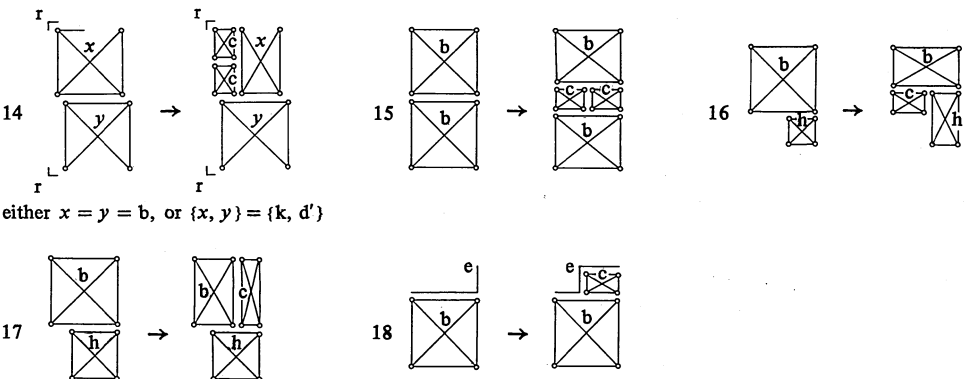

Figure 11. Shape  $C_4$  generated from shape  $C_3$  by two applications of schema 11.

*Stage 5: addition of built-in closets*

All bedrooms in our sample have direct access to a built-in closet. The placement of these closets assures that the boundary of the bedrooms retains its regular (mostly rectangular) form. Indications for a similar notion of 'good shape' can also be found for other primary spaces and will be discussed below. The notion seems to be less strong for secondary spaces, such as bathrooms or halls, whose regular boundary is more frequently interrupted by closets placed in corners (see plans B, E, or G). The schemata in figure 12 deal only with the placement of closets next to primary spaces.

Schema 14 allocates two closets next to two spaces, *x* and *y*, so that one closet is accessible only from space *x* and the second closet could be accessible from both spaces. The form of this schema is general enough to generate not only the closets next to the bedrooms in plan G, but also the small ancillary spaces at the back of plan A (provided the meaning of the symbol *c* is properly extended). Applications of schema 14 are restricted to the rear of a plan since it is only there that the configurations of closets generated by the schema occur in our sample. Schema 15 places two closets between two adjacent bedrooms whose left-hand and right-hand boundaries must be aligned; this situation can only occur at the rear of a plan. Schemata 16 and 17 allocate a closet next to a single bedroom and an adjacent hall, a configuration which cannot occur at the rear of a plan. Applications of schemata



either  $x = y = b$ , or  $\{x, y\} = \{k, d'\}$

Figure 12. Schemata to add built-in closets to primary spaces.

14 to 17 reduce the size of certain primary spaces and are restricted to cases in which this size does not drop below some given limit. No restriction of this kind is imposed on applications of schema 18, which generates a closet from the outside by extending the length of a bay created in the previous stage.

An application of schema 16 to shape  $C_4$  generates shape  $C_5$  in figure 13, in which a closet is placed next to the right-most bedroom. No application of schemata 14 to 18 can, however, be used to produce the closet next to the left-most bedroom in plan C; this special case will be dealt with in the next stage.

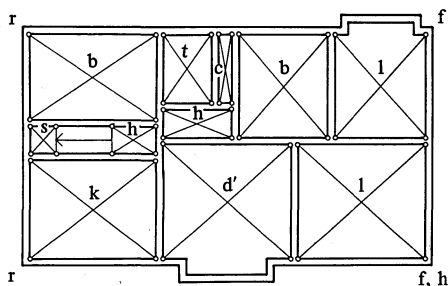

Figure 13. Shape  $C_5$  generated from shape  $C_4$  by an application of schema 16.

*Stage 6: merging of spaces*

To generate most of the plans in our sample, adjacent halls or living rooms that were generated in previous stages must be merged into larger, continuous areas. The schemata to be used for this purpose are shown in figures 14 and 15.

Figure 14 shows the schemata which merge two cells labelled 1 into a larger living room, labelled 1', or confirm the existence of two separate living spaces when the conditions for a successful combination are not met. The simplest case is handled by schema 19, which can be applied if the left-hand and right-hand boundaries of the cells to be merged are aligned; the schema removes the wall between the cells and thus generates a larger space with a rectangular boundary.

There exists a special case in which the same result can be achieved even if the alignment conditions specified by the left-hand side of schema 19 are not met. These conditions are given by the left-hand side of schema 20; it shows two cells labelled 1 and a flight of stairs leading to the upper floor so that these areas can be enclosed by a rectangular boundary. The schema removes the walls between the areas and generates a living room which has the desired shape, but contains a flight of stairs in one corner (see plan G).

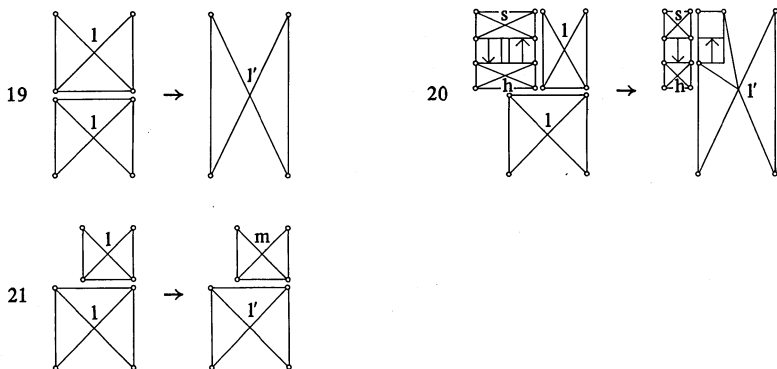

Figure 14. Schemata to merge two living rooms or to confirm the existence of two separate living spaces.

Plan C is the only plan in our sample which contains two smaller living spaces instead of a single, larger one. These two spaces are, however, adjacent, and removing the wall which separates them would create a single, larger room, albeit with a nonrectangular, L-shaped boundary. In plan C, the two spaces are indeed connected, but by an opening which leaves enough wall area to its right and left to preserve the formal integrity of the connected spaces. Schema 21 deals with this case. It changes only the labels attached to the cells labelled 1; the larger one receives the label  $l'$  and becomes thus equivalent to the living rooms generated by schemata 19 or 20, whereas the smaller one receives the label  $m$ , which identifies it as a smaller living space. A connection between the two spaces will be added during a later stage.

The schemata in figure 15 merge two adjacent halls into a single, continuous space or confirm the existence of separate halls which cannot be merged. Properly formed halls are marked by the label  $h'$ . Schema 22 generates a rectangular space out of two halls whose left-hand and right-hand boundaries are aligned. Schema 23 forms an L-shaped space out of two halls which are aligned only along their right-hand boundary. Schemata 24 and 25 mark rectangular halls which are not adjacent to other halls as properly formed.

Schemata 22 to 25 generate all halls in our sample except for the hall in plan C, which has a rather odd shape and does not fit neatly into the simple, orthogonal geometry on which the given plans are so obviously based. A possible explanation for this case can be derived from the difficulties posed by the spaces near the upper left corner in shape  $C_5$ . Among these spaces are two halls which are adjacent to each other, but cannot be merged into a continuous space simply by removing a shared wall segment (since the resulting opening would be too narrow for convenient passage). The halls can only be combined if the shape of one of the surrounding

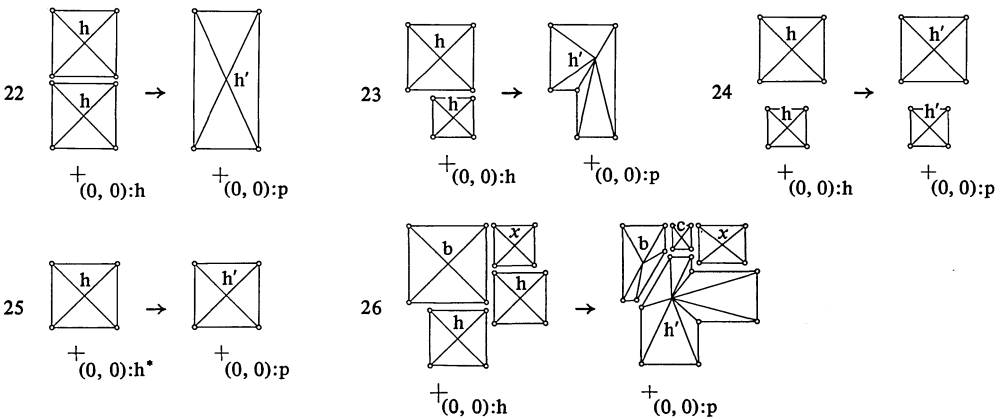

Figure 15. Schemata to merge two halls or to confirm the existence of halls which cannot be merged.

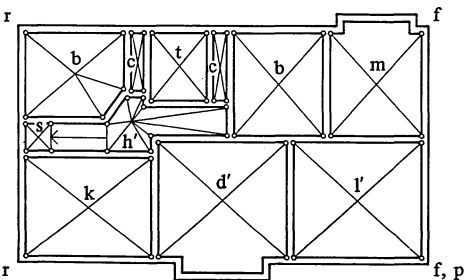

Figure 16. Shape  $C_6$  generated from shape  $C_5$  by application of schemata 21 and 26.

spaces is also changed. In addition, no closet can be placed next to the left-most bedroom through the standard operations given by schemata 14 to 18. In plan C, these difficulties are resolved by means of unconventional shapes (which, in practice, might have been created through ad hoc decisions during construction). At some point, we were tempted to declare such shapes 'ungrammatical' (see Glassie, 1975, page 31) and to exclude them from the language  $\Lambda$ . We decided, however, to defer such judgements until our sample has grown in size and to include special schemata which would generate exceptional configurations of shapes. Schema 26 deals with the present case. It must be used, together with schema 21, to transform shape  $C_5$  into shape  $C_6$  shown in figure 16.

*Stage 7: addition of a porch*

All bungalows in our sample contain a porch facing the street. It can be open or enclosed, but is always centered about the longitudinal axis of the plan. The schemata needed to generate the given porches are shown in figure 17.

The first two schemata in figure 23 add a porch to shapes generated in previous stages and establish the formal relation between the porch and the rest of the plan. Schema 27 creates a porch by extending the front of the plan; the rectangular enclosure generated by schema 1 becomes thus enlarged, and the porch is integrated into it. Schema 28 generates a porch which remains an addition to the building and can be perceived as such. Schemata 29 or 30 can then be used, respectively, to divide the porch into an open and enclosed section or to enclose the entire porch.

The open porch of plan C is generated by an application of schema 28 to shape  $C_6$ ; the resulting shape,  $C_7$ , is shown in figure 18.

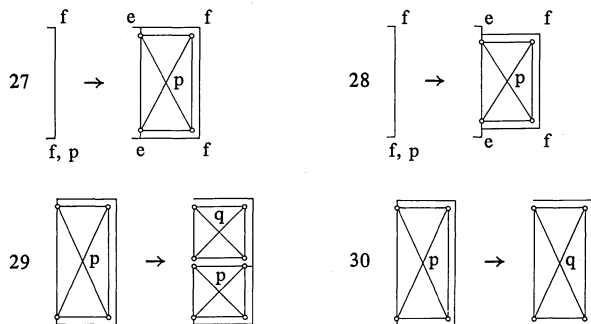

Figure 17. Schemata to add a front porch.

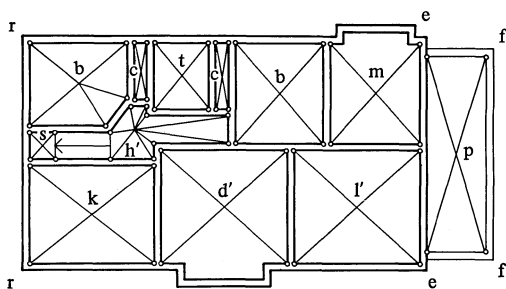

Figure 18. Shape  $C_7$  generated from shape  $C_6$  by an application of schema 28.



#### 4 The second part of the grammar: generation of connections

The schemata given in the first part of the grammar produce layout schemes which define the location and shape of all spaces in a plan with the exception of certain small ancillary spaces. The second part of the grammar consists of schemata which generate connections between spaces and the outside in the form of entrances or windows as well as connections between pairs of spaces in the form of doors or openings.

##### Stage 8: generation of a front entrance

Front entrances always make the living room accessible from the street either directly or through a vestibule which serves as an air lock between the inside of the building and the outside. The schemata that add a front entrance to a plan are shown in figure 19.

Schemata 31 to 34 generate front entrances which can be reached from an open porch. Schema 31 gives the simplest case: the entrance is created by placing a door into the wall separating the living room from the porch (see plan C). The next three schemata enclose part of the porch in order to create a vestibule. Schema 32 generates a free-standing vestibule (see plan D). Schema 33 places a vestibule into a corner of the porch (see plan A). The porch must have a certain minimum length and width if schemata 32 or 33 are to be applied. If the width of the porch is small (because schema 29 was used to enclose a section of it), schema 34 can be applied to generate a vestibule by enclosing the entire back of the open section (see plan F). If, conversely, the length of the open porch is small, schema 35 could be used to generate a vestibule along an entire side of the porch; this schema does not generate any entrance found in our sample, but is shown here to complete the list of possibilities for generating vestibules on an open porch. Schema 36 generates a vestibule in an enclosed porch which occupies the entire front of a plan (see plan G). Schema 37, last, generates a vestibule in a corner of the living room and makes it accessible from an open porch (see plan E).

Applications of schema 37 severely violate the notion of good shape that seems to underly the design of the primary spaces in our sample. At the present time, we

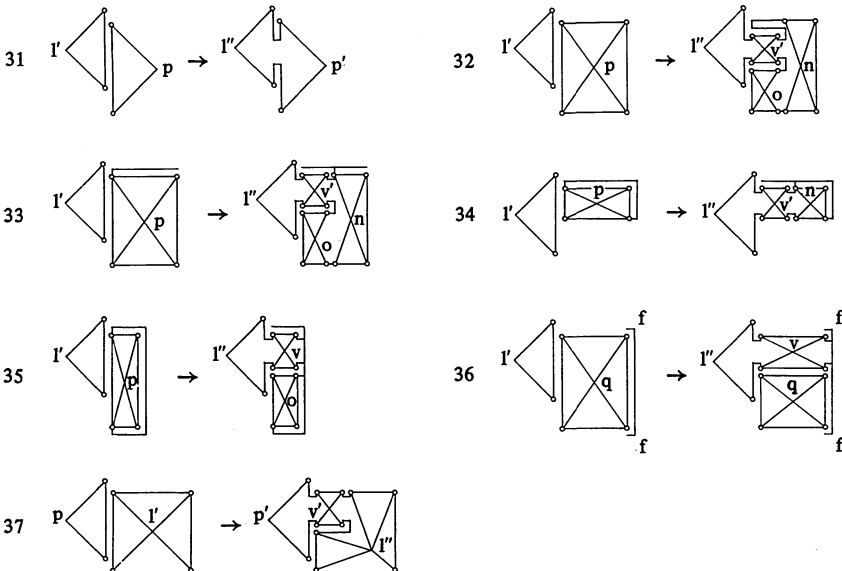

Figure 19. Schemata to generate a front entrance.

consider the front entrance in plan E as an intermediate step in the evolution of well-adapted solutions for the design of entrances or porches in the region from which our sample is drawn. The severe winters for which Buffalo is notorious seem to give the advantages to both a vestibule and an enclosed porch, elements which are allocated efficiently in the most recent bungalows F and G.

It should be noted that exactly one of the schemata in figure 19 must be applied in the generation of a plan in  $\Lambda$ . These applications, in turn, are possible only for shapes in which a living room is adjacent to a front porch. This relation is already guaranteed for any shape produced in the previous stage by devices which are, therefore, from a purely formal point of view redundant. But these and similar redundancies were introduced to provide the generation process from the beginning with a sense of direction, which we consider helpful, given the size of the present grammar. No systematic attempts were made, however, to prevent entirely the generation of intermediate shapes which cannot be developed into plans in  $\Lambda$ .

Probably to reduce excavation costs, the first floors are raised above street level in all bungalows. Vestibules that border the front of a plan or porches that must be crossed to reach the front entrance, therefore, have to be connected to the street by a flight of stairs. The schemata in figure 20 can be used for this purpose.

Schemata 38 and 39 place stairs, respectively, in front of a porch and a vestibule. The first of these must be used to generate the front stairs in plans A or C; the second schema does not generate a shape found in our sample, but was added to the grammar again to complete a list of possibilities. Schema 40 adds stairs from the side of a porch (see plans B or E), and schema 41 allocates stairs inside a vestibule (see plan G). It should be noted that schemata 38 to 41 (as well as schemata 8 and 9) are only meant to indicate the location of flights of stairs and their direction; our grammar does not deal with the details of stair design, such as number of risers or railing forms.

Figure 21 shows a shape  $C_8$ , which is generated from shape  $C_7$  by applications of schemata 31 and 38.

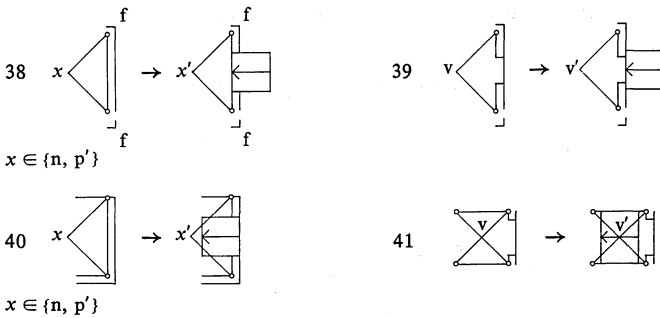

Figure 20. Schemata to add front stairs.

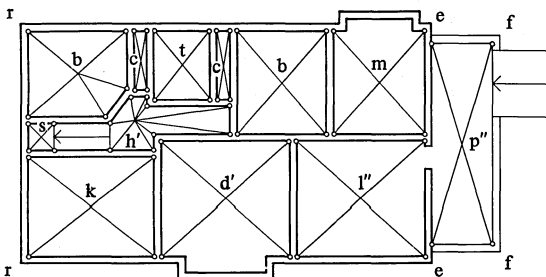

Figure 21. Shape  $C_8$  generated from shape  $C_7$  by applications of schemata 31 and 38.

*Stage 9: generation of a second entrance*

Each bungalow in our sample contains, in addition to a front entrance, a second entrance at the side or rear. Kitchen and basement stairs are always accessible from that entrance. It is generated by the schemata in figure 22.

Schema 42 generates the standard solution for a side entrance. It locates a door between the kitchen and hall at the top of the flight of stairs leading down to the street level and makes these stairs accessible from the outside by a second entrance. The stairs function, at the same time, as an airlock. Schema 43 generates the analogous solution for a rear entrance, a possibility which is not realized by any plan in our sample. To generate the given rear entrances, schemata 44 or 45 must be applied; in the first case, a vestibule is added from the rear (see plan C, and in the second case, a vestibule is created by reducing the size of the kitchen (see plan D).

To transform shape  $C_8$  into shape  $C_9$ , shown in figure 23, schema 44 must be applied. It should be noted that the entrances generated by schemata 43 to 45 must be made accessible from the street level through back stairs. The generation of such stairs is straightforward and not given here.

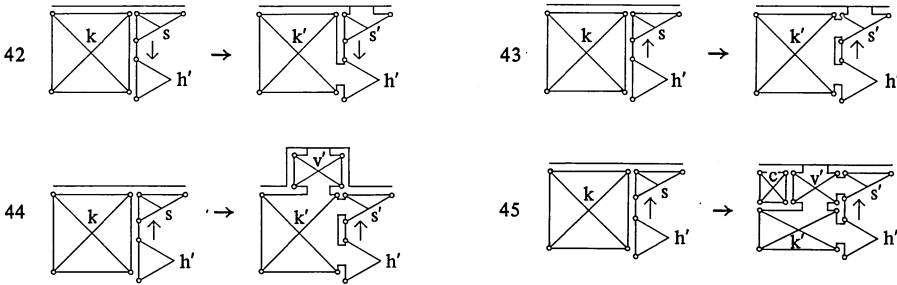

Figure 22. Schemata to generate a second entrance.

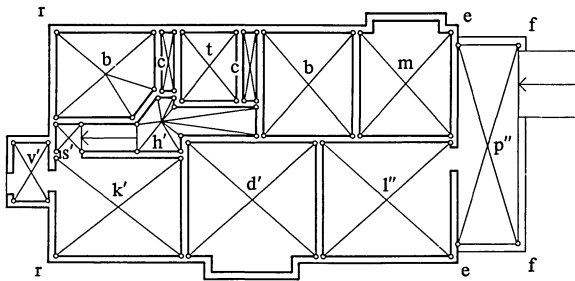

Figure 23. Shape  $C_9$ , generated from shape  $C_8$  by an application of schema 44.

*Stage 10: generation of internal doors and openings*

In all bungalows, internal doors are used to connect the following pairs of spaces:

- bedroom and hall,
- bathroom and hall,
- closet and either bedroom or some other adjacent space.

Additional doors connect the following pairs of spaces in almost all plans:

- dining room and kitchen,
- hall and either living room or dining room.

The few instances in which some of these doors are missing will be explained below.

Large openings are always used to connect the following pairs of spaces:

- living room and dining room,
- two adjacent living spaces,
- enclosed porch and either living room or dining room.

In many instances, screen or window walls are used to enclose parts of the openings. Most conspicuous among these are the screen walls placed in the openings between living rooms and dining rooms. They represent the most elaborate pieces of internal decoration found in the bungalows in our sample and consist, in their standard form, of two columns placed on two balustrades which divide the opening into three sections so that the center section can be used as an open passage between living room and dining room; figure 24 shows an example.

It should be noted that these openings are large enough to generate continuous areas which can extend over several spaces (especially in plans F and G), but are never allowed to dissolve completely the walls in which they are placed; the formal integrity of the connected spaces thus remains intact.

The schemata which generate all of the listed connections are shown in figure 25. Schema 46 allocates all doors, and schema 47 generates all of the larger openings. The remaining schemata can be used to modify the resulting shapes or to achieve similar effects through more elaborate means.

In some instances, repeated applications of schema 46 produce tight configurations of doors at certain points in a plan, especially where dining room, kitchen, and hall meet. In such cases, schema 48 can be used to remove either the door between

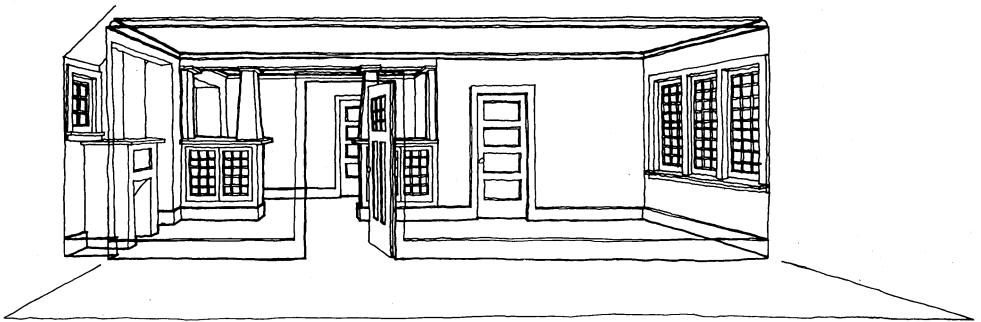
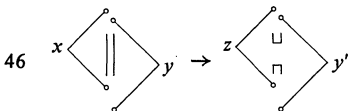
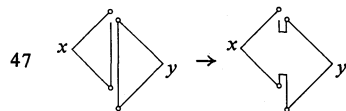

Figure 24. Screen wall between living room and dining room in bungalow D.



- either  $x = z = k'$  and  $y = d'$
- or  $x = z = h'$  and  $y = b$
- or  $x = z = h'$  and  $y = t$
- or  $x = z, z \in \{d'', l''\}$ , and  $y = h'$
- or  $x = b', z = b'',$  and  $y = c$
- or  $x = z$  and  $y = c$



- either  $x = l''$  and  $y \in \{d'', m\}$
- or  $x \in \{l'', d'''\}$  and  $y = q$

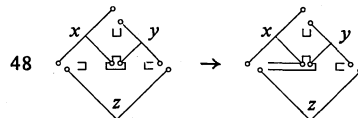

- either  $x = k', y = h'',$  and  $z = d''$
- or  $x = d'', y = k',$  and  $z = h''$

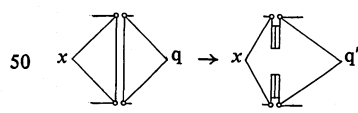
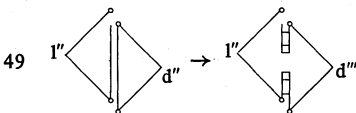

- $x \in \{l'', d'''\}$

Figure 25. Schemata to generate internal connections.

kitchen and dining room (provided these spaces are in easy reach across a hall) or the door between dining room and hall (provided the hall can be reached through the kitchen); examples are given in plans D and E.

Schema 49 can be used instead of schema 47 to generate an opening between living room and dining room and to place a screen wall into this opening. Similarly, schema 50 connects an enclosed porch with an adjacent space through a window wall (provided the boundaries of the two spaces are properly aligned); the schema can also be used to extend the back of the porch and reduce the size of the adjacent space (see plan E).

To transform shape  $C_9$  into shape  $C_{10}$  shown in figure 26, schemata 46, 47, and 49 must be applied.

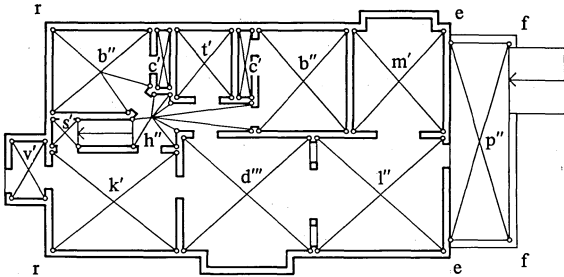

Figure 26. Shape  $C_{10}$  generated from shape  $C_9$  by applications of schemata 46, 47, and 49.

### Stage 11: generation of windows and fireplaces

In the bungalows in our sample, all primary spaces and some secondary spaces are connected to the outside through windows. The buildings also contain fireplaces which, in some instances, are purely decorative features, that is, not connected to a flue. The locations of windows and fireplaces are closely related; our grammar therefore generates these elements simultaneously. The required schemata are shown in figures 27 and 28.

Schema 51 generates windows in kitchens, bathrooms, and bedrooms. The windows form a rectangular opening whose size is usually small relative to the area of the wall in which it is placed. It might consist of two or more sections, but the schema is not intended to specify such details.

Schemata 52 and 53 generate the windows in a dining room or small living space. In our sample, the form of these windows is highly conventionalized: it consists of two identical, narrow openings which are placed at some distance from each other and are, in most cases, connected by a third window whose sill is considerably higher than the sills of the windows to its right or left. The shape formed by these windows is easily recognized from the outside (see, for example, the side elevations of bungalows D and E).

Schema 54 provides an enclosed porch with a row of front windows whose size is usually large relative to the area of the wall in which it is placed (see plans E to G). Again, the schema does not specify the number of windows contained in that row. The notations used in schemata 51 and 54 to represent windows graphically are also employed by subsequent schemata to distinguish basic types of windows without specifying the exact details of their design.

The next three schemata generate front windows for a living space or dining room which is adjacent to an open porch. Schema 55 places a window in a wall whose width is small (see plan E). Schemata 56 and 57 generate, respectively, one and two rows of windows in walls of suitable widths (see plans A or C).

The last four schemata in figure 27 generate side windows for an enclosed porch, which is always bordered from one side by a vestibule or an open porch. The left-hand sides of schemata 58 to 61 give the possible cases for the length of these adjacent areas, and the right-hand sides allocate the windows accordingly.

The schemata in figure 34 generate windows or fireplaces in walls at the sides of a living room. The first three of these schemata can be applied when the living room runs the entire front of a plan, but does not contain a bay. Windows are generated at both sides of that space. The placement of these openings is bilaterally symmetric about the longer axis of the living room, and fireplaces are always integrated into this composition (see plans A, F, and G).

Schema 65 places windows in the side walls of a living room with a bay. The resulting configuration of windows is analogous to one produced by schema 62. Schemata could be added which would also generate configurations analogous to the ones produced by schemata 63 or 64, but are not needed to generate the cases found in our sample. Schemata 66 and 67 generate side windows or fireplaces at one side of a living room which does not occupy the entire front of a plan (see plans C and E).

Schema 68, finally, generates the special arrangement of windows and fireplace in plan B. It can be applied only if the living room occupies the entire front of a plan, but generates shapes which differ drastically from those that are produced by schemata 62 to 64. The fireplace is placed into a corner, but not against an exterior wall. The width of the living room is consequently reduced, and the area made thus

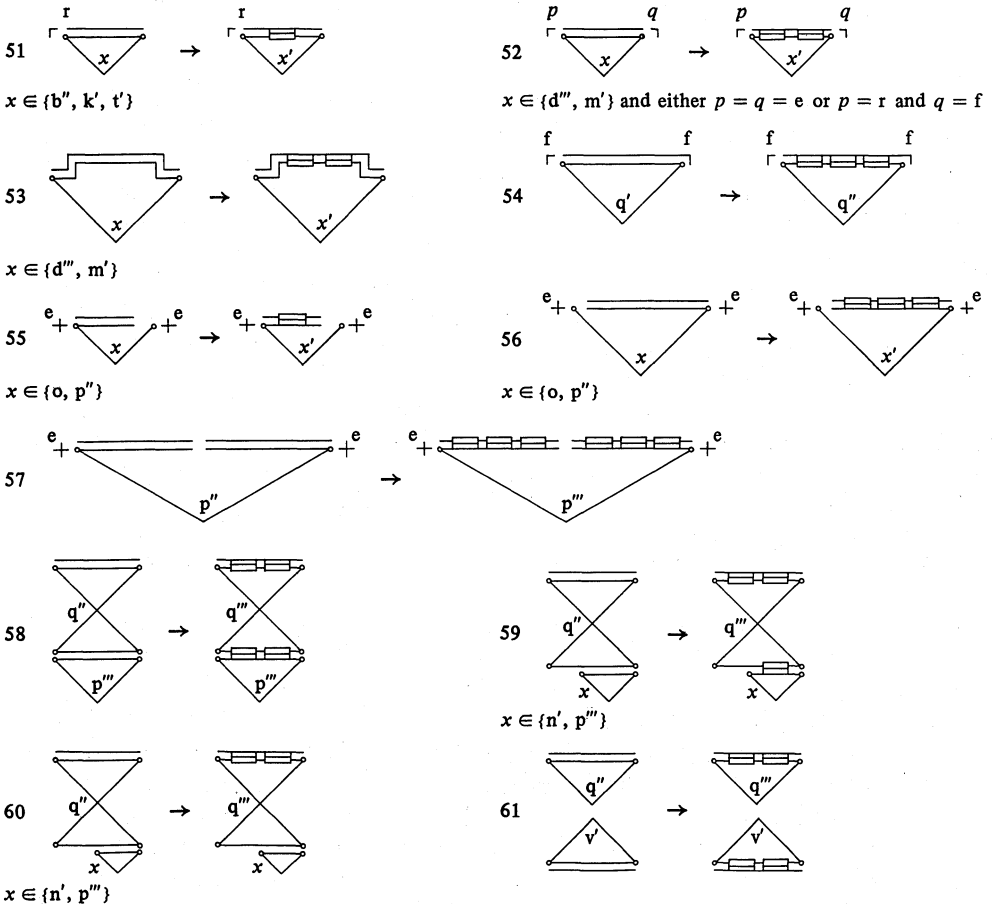

Figure 27. Schemata to generate windows.

available is used partially to generate a vestibule and partially to increase the size of the kitchen.

Applications of schemata 51, 53, 57, and 66 are needed to transform shape  $C_{10}$  into shape  $C_{11}$  shown in figure 29.

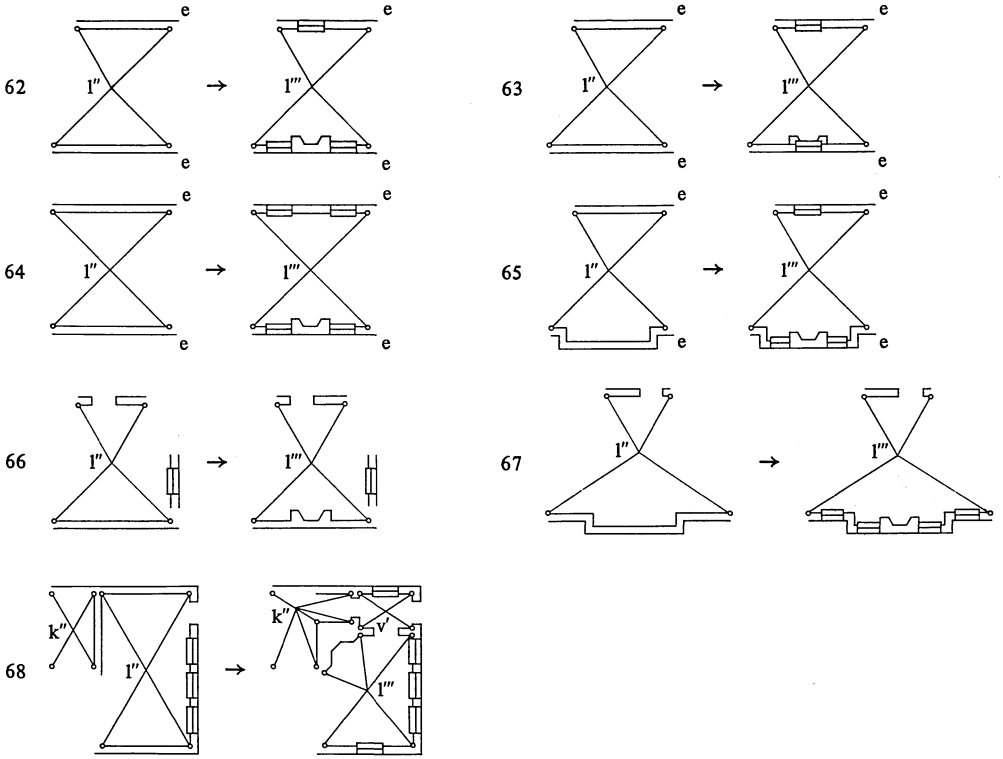

Figure 28. Schemata to generate windows and fireplaces.

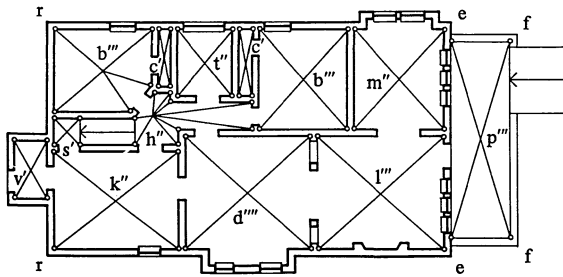
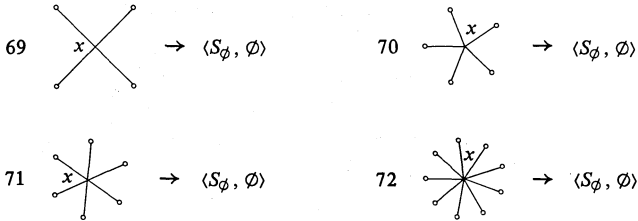

Figure 29. Shape  $C_{11}$  generated from shape  $C_{10}$  by applications of schemata 51, 53, 57, and 66.

*Stage 12: termination of the design process*

The schemata in figure 30 remove labels from spaces or corners; they also erase lines that were drawn across spaces. Notice that a label is removed from a space only if that space possesses a certain number of required features. In addition, a label can be removed from a space only if the size and dimensions of that space satisfy certain minimal requirements (which can be expressed as functions of the coordinates of the points labelled  $\circ$ ). Schemata 69, 72, and 73 must be applied to remove the labels from shape  $C_{11}$ ; the resulting shape,  $C^*$ , belongs to  $\Lambda$  and is shown in figure 31.

Shape  $C^*$  does not represent plan C in all of its details. Other plans in our sample, too, contain a range of details or optional features which are not generated by our grammar. Among these are additional windows in bedrooms or kitchens; smaller closets in halls or bathrooms; or porches and third entrances at the rear. The addition of schemata to generate these elements would be straightforward and is not given here.



$x \in \{b''', c', d''', h'', k'', l''', m'', n', o', p''', q''', s', t'', v'\}$  for schemata 69 to 72

73  $p + \rightarrow \langle S_\phi, \emptyset \rangle$

$p \in \{r, f, e\}$

Figure 30. Schemata to terminate the generation process.

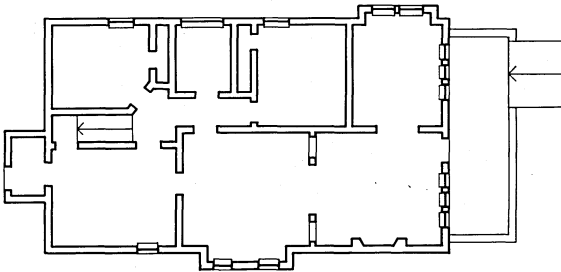

Figure 31. A shape  $C^*$  generated from shape  $C_{11}$  by application of schemata 69, 72, 73.

## 5 Discussion

Our sample is admittedly small, and the generalizations we were willing to draw from it must be considered tentative. We intend to obtain measured drawings of additional bungalows and to review our conclusions accordingly.

It appears illuminating in this context to gain an overview of the plans in  $\Lambda$ . The language itself is infinite if some assignments of values are allowed to vary continuously. It is customary in such cases to enumerate classes of shapes in the language, rather than the shapes themselves. The enumeration shown in figure 32 appears particularly useful for the present context. It describes all combinations in which the schemata given for the first three stages can be applied in the production of a plan in  $\Lambda$ , and the plans themselves can be classified according to the combination required in their generation. The enumeration assumes that bathrooms and staircases cannot occupy the same zone and distinguishes between variations caused by different values given to the variable labels in schemata 8 to 10.

Six classes are yielded by the enumeration; in figure 32, they are represented by simplified shapes all of which can be developed into plans in  $\Lambda$  during subsequent stages. Five of the classes contain houses from our sample. A good test for the validity of our conclusions would be the discovery of a plan in class 1, the only class generated by our grammar for which our sample does not contain a member. If no such plan can be found, the particular set of conventions on which the schemata in



our grammar are based would have to be revised (for example, by treating the plans without bedrooms more independently).

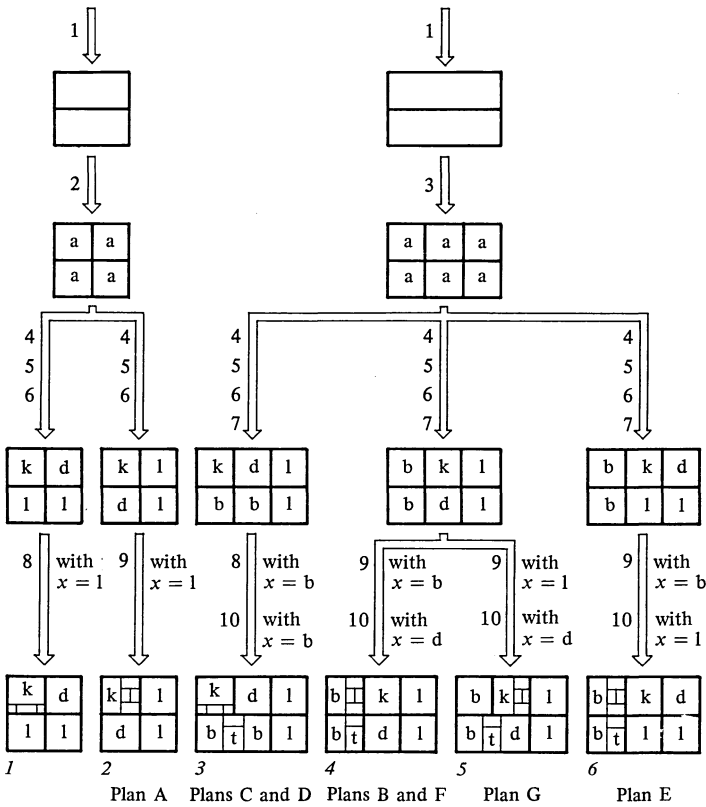

Figure 32. Enumeration of classes 1-6 of bungalow plans.

**Acknowledgements.** Part of the research reported in this paper was supported by a grant from the Research Foundation of the State University of New York at Buffalo.

**References**

Downing F, 1982 "The common bungalow planning tradition" *Little Journal Society of Architectural Historians*, Western New York Chapter, Buffalo, NY (forthcoming)

Flemming U, 1981a "The secret of the Casa Giuliani Frigerio" *Environment and Planning B* 8 87-96

Flemming U, 1981b "Structure in bungalow plans" *Environment and Planning B* 8(4) forthcoming

Glassie H, 1975 *Folk Housing in Middle Virginia* (University of Tennessee Press, Knoxville, Tennessee)

Hodgson F T, 1912 *Practical Bungalows and Cottages for Town and Country* (Frederick J Drake and Co., Chicago, Illinois)

Saylor H H, 1911 *Bungalows* (McBride, Winston and Co., Philadelphia, Pennsylvania)

Stickley G, 1979 *The Best of Craftsman Homes* (Peregrine Smith, Salt Lake City, Utah)

Stiny G, 1980 "Introduction to shape and shape grammars" *Environment and Planning B* 7 343-351

Stiny G, Mitchell W J, 1978 "The Palladian grammar" *Environment and Planning B* 5 5-18

Yoho J, 1914 *Craftsman Bungalows* (Empire Building, Seattle, Washington)