

Upper Level

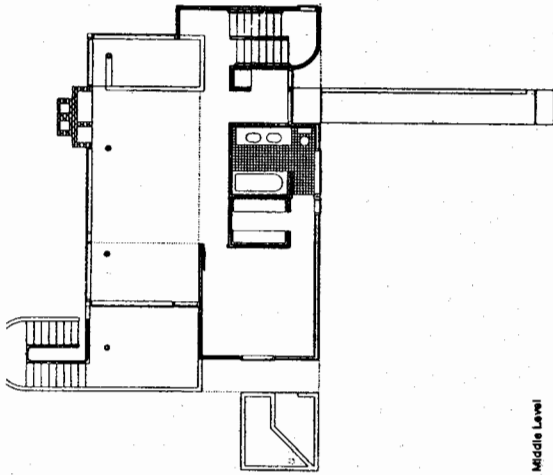

Middle Level

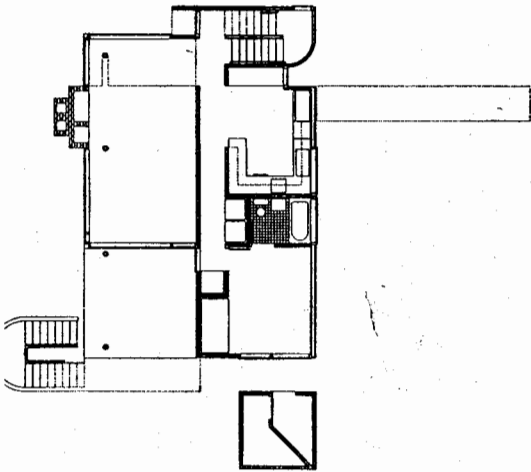

Lower Level

Southeast Elevation

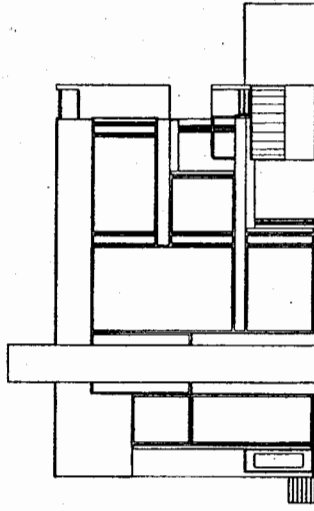

Northwest Elevation

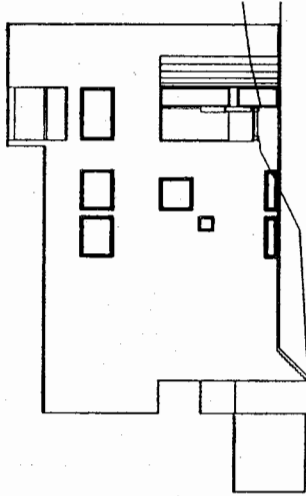

Section

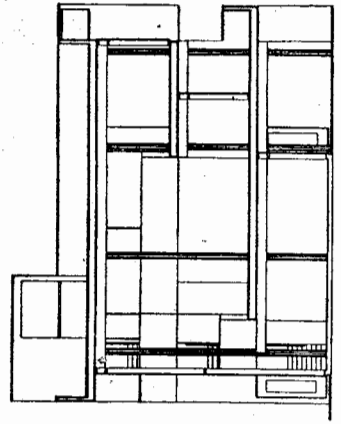

Section

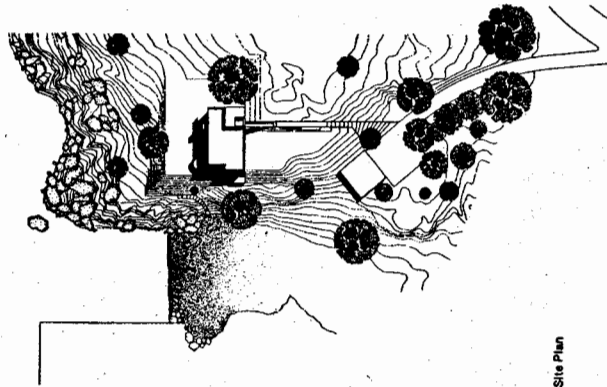
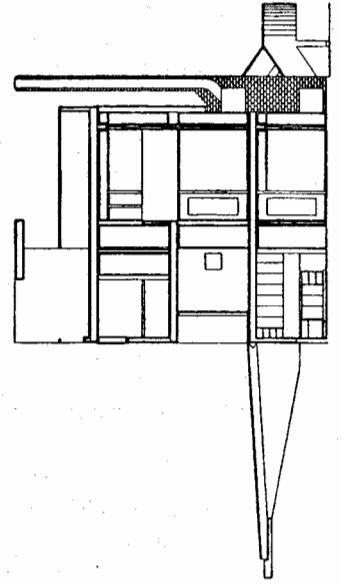

Site Plan

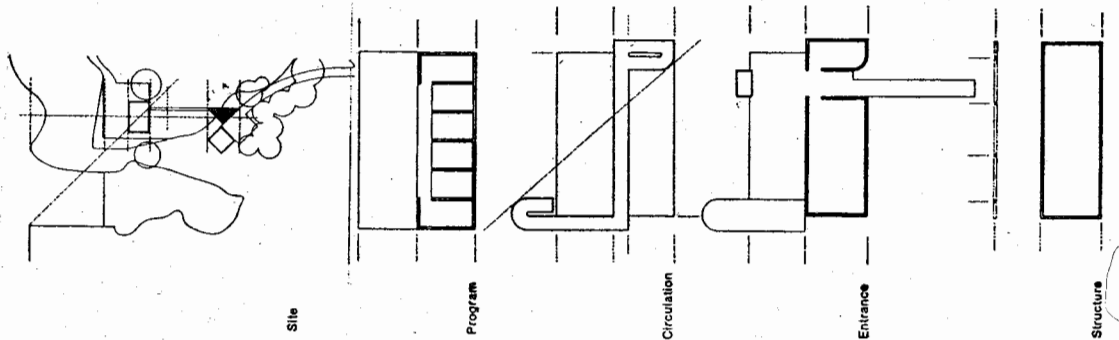

Site

Program

Circulation

Entrance

Structure

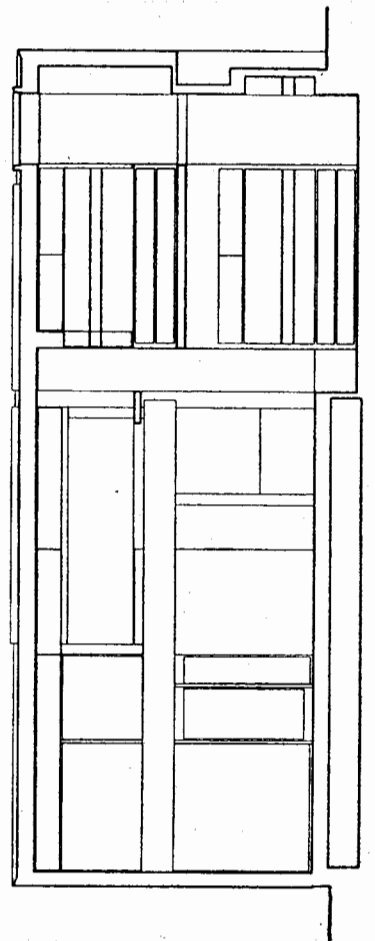
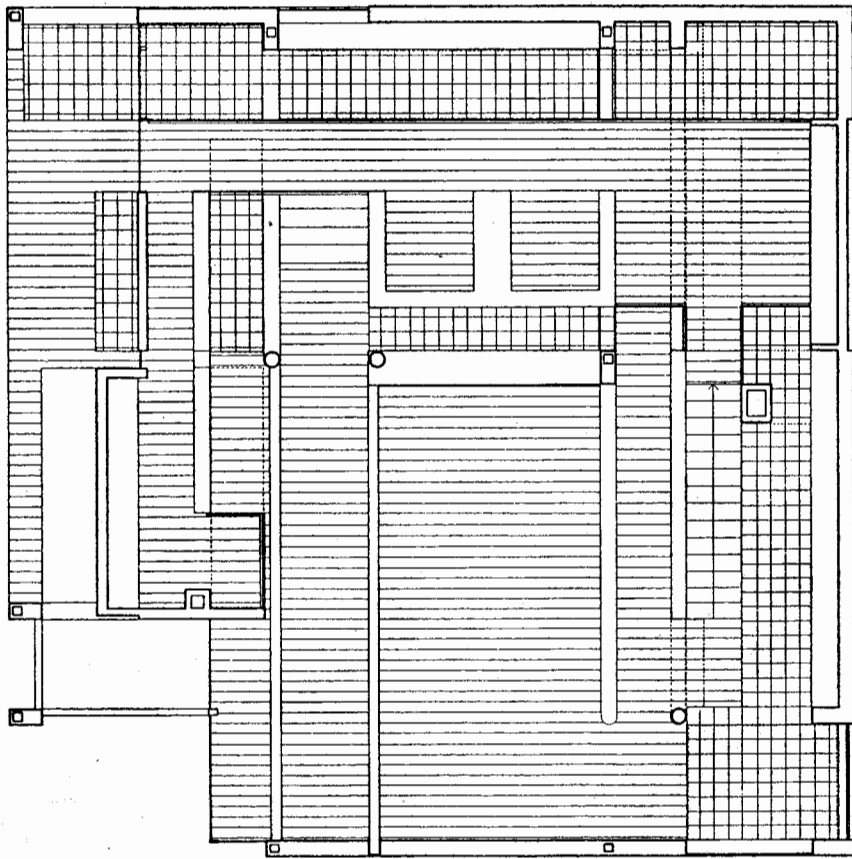
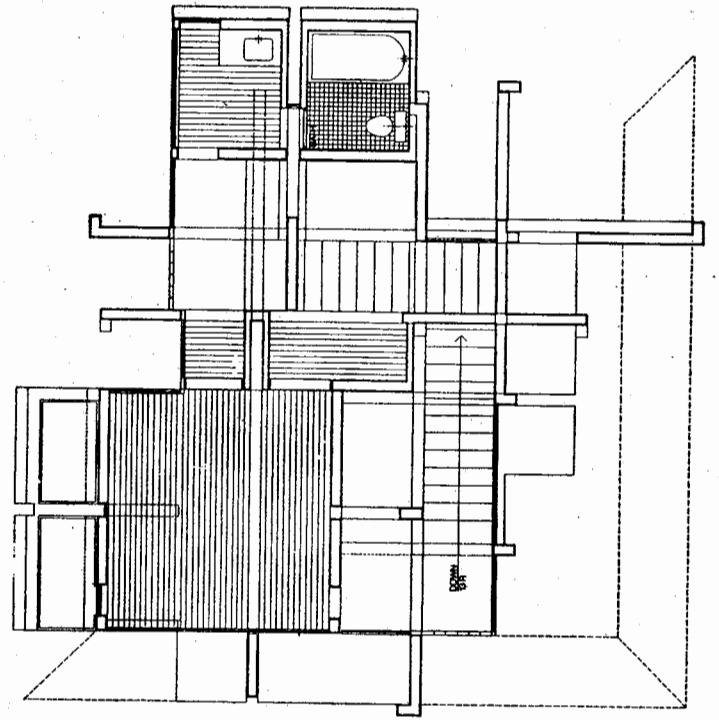
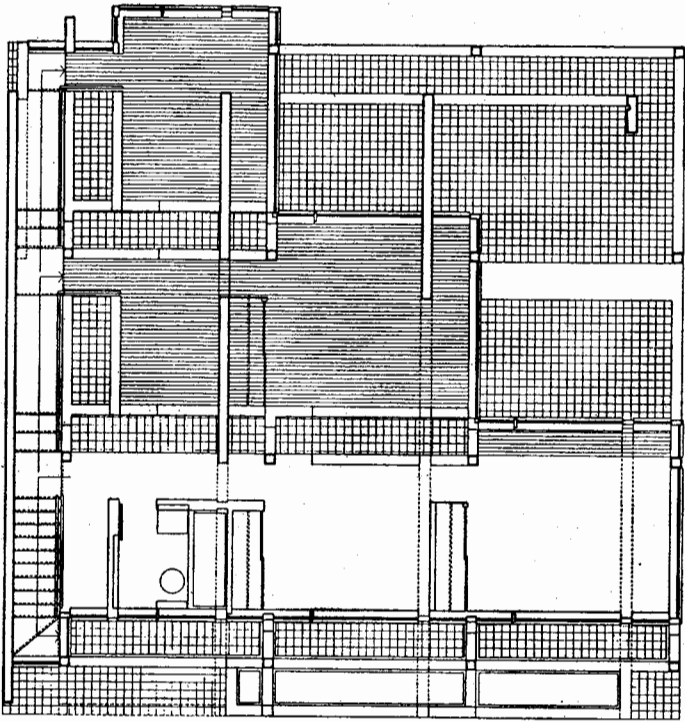

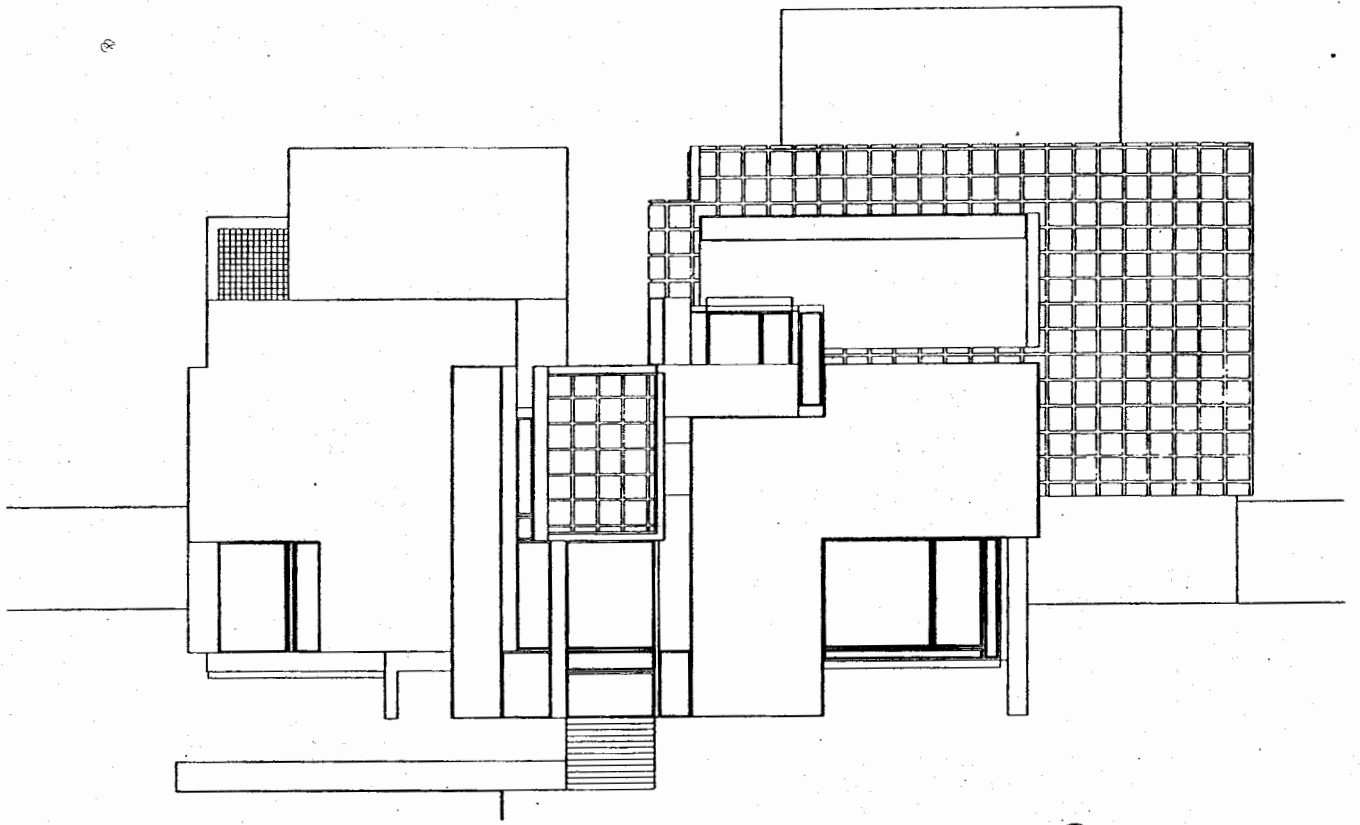

1 5 10

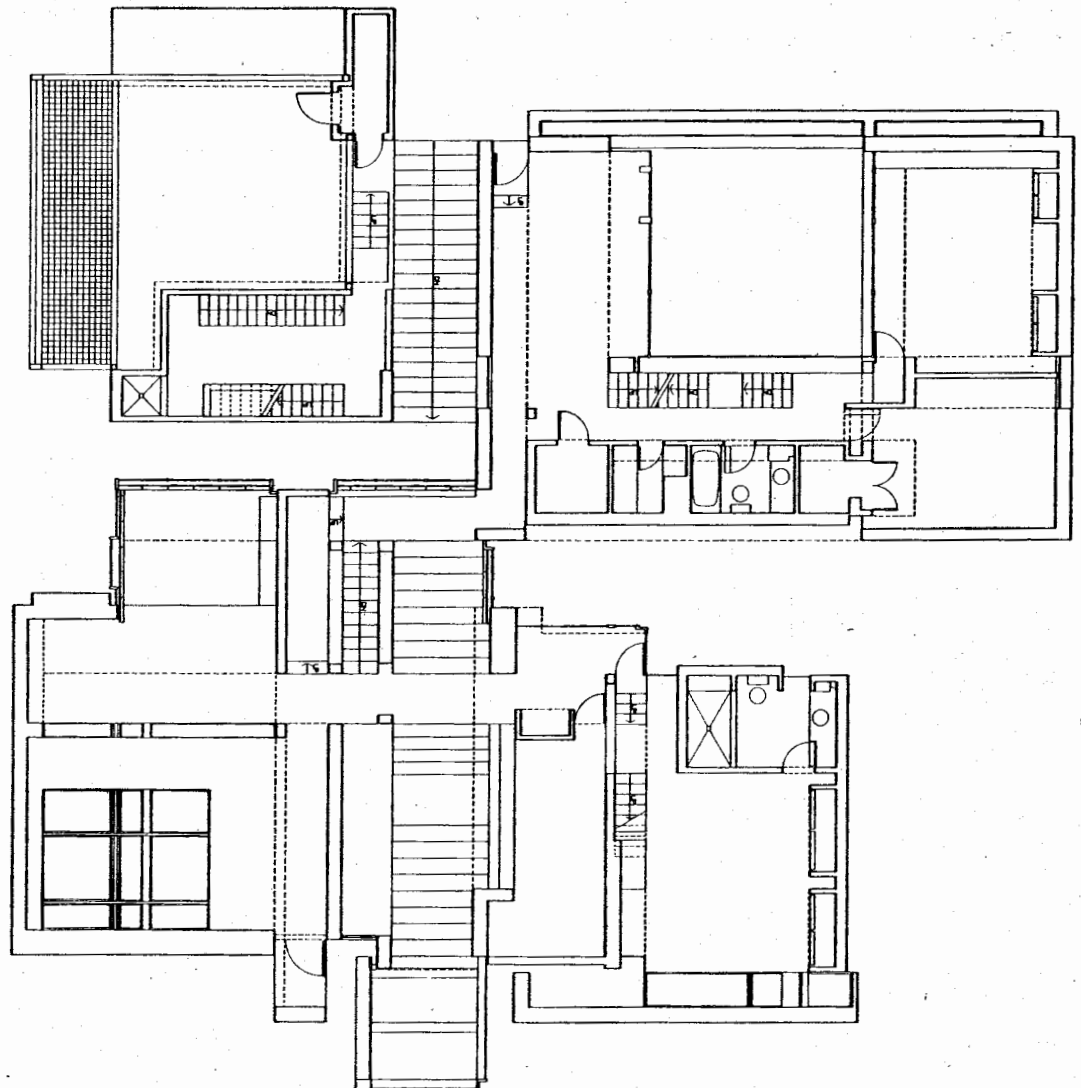

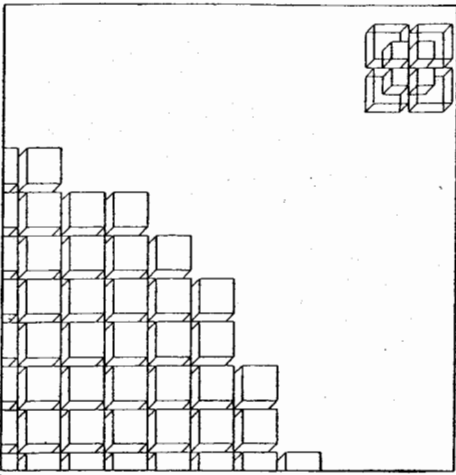

204

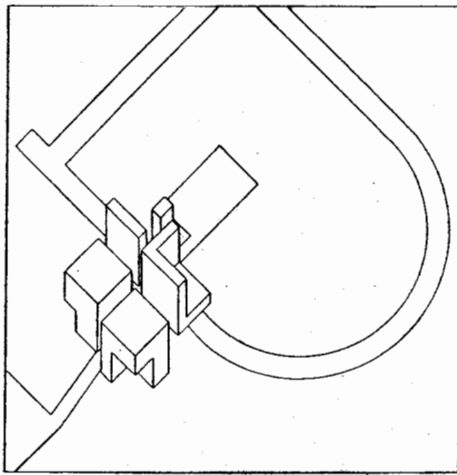

205

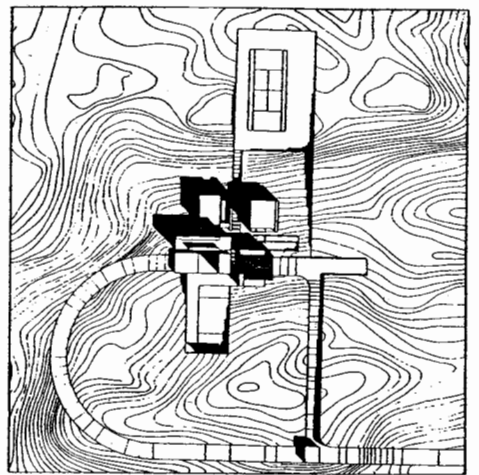

206

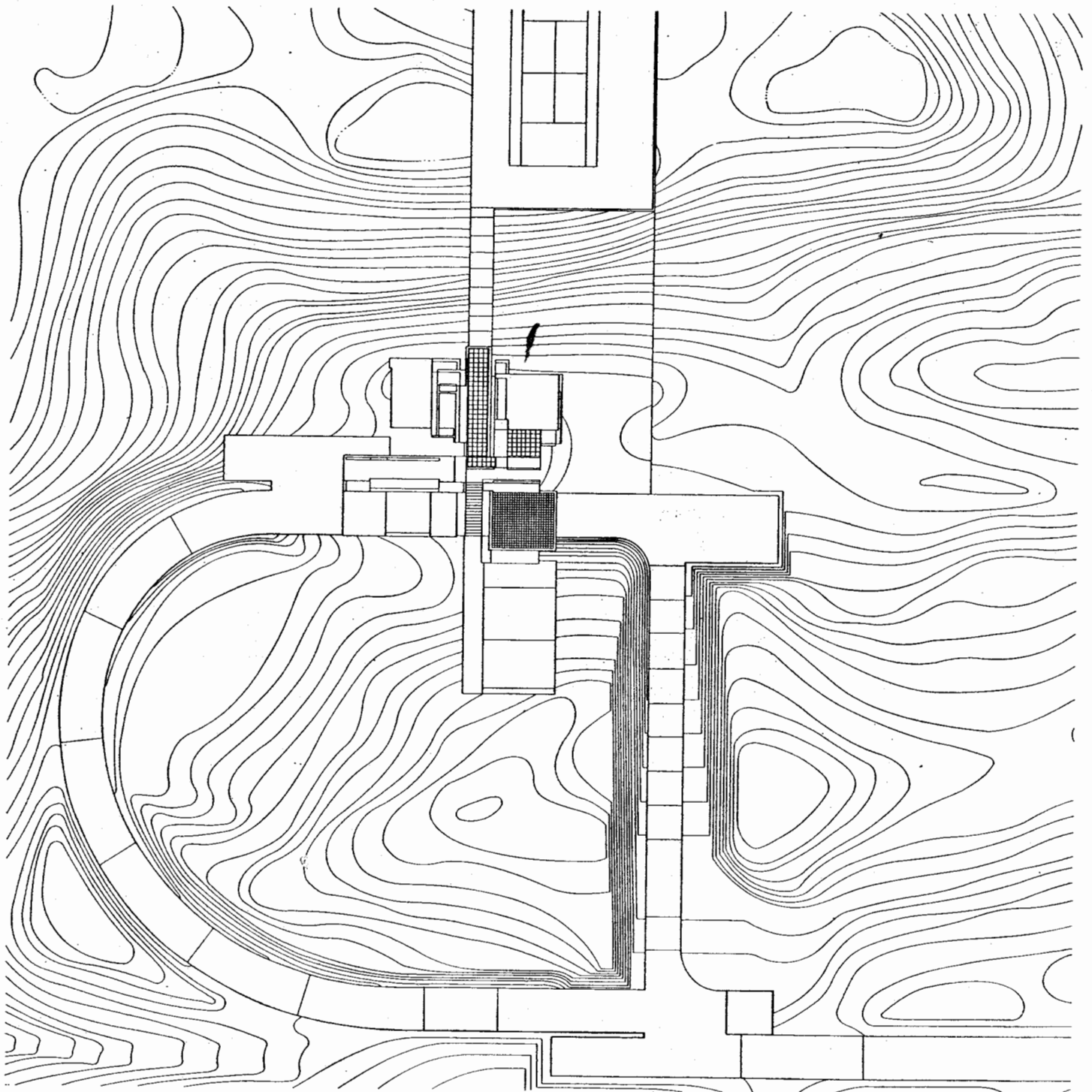

208

11

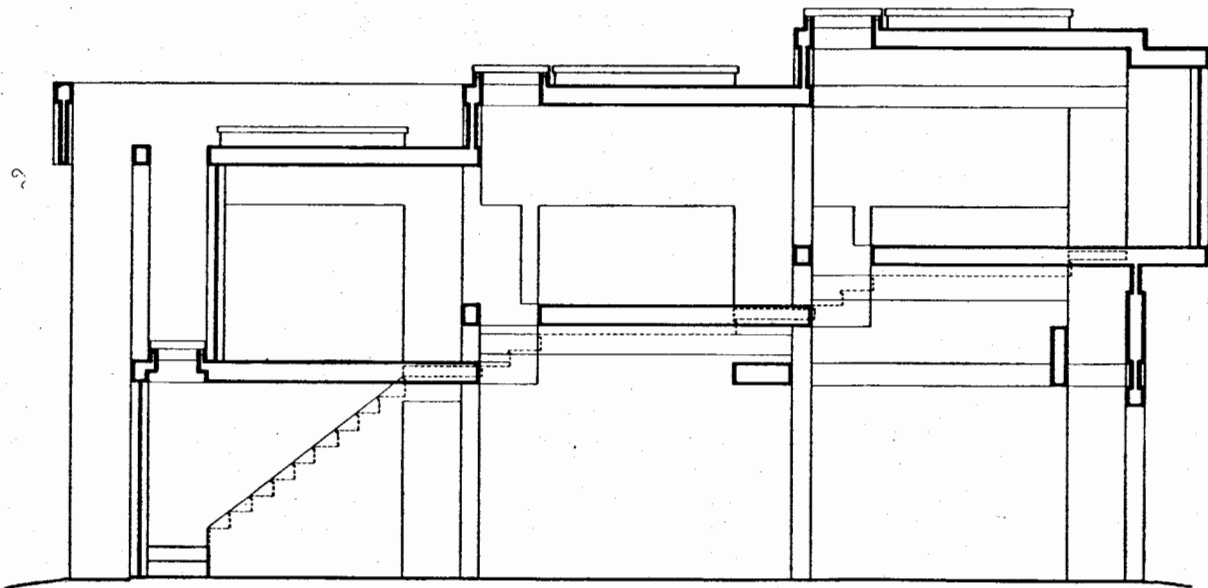
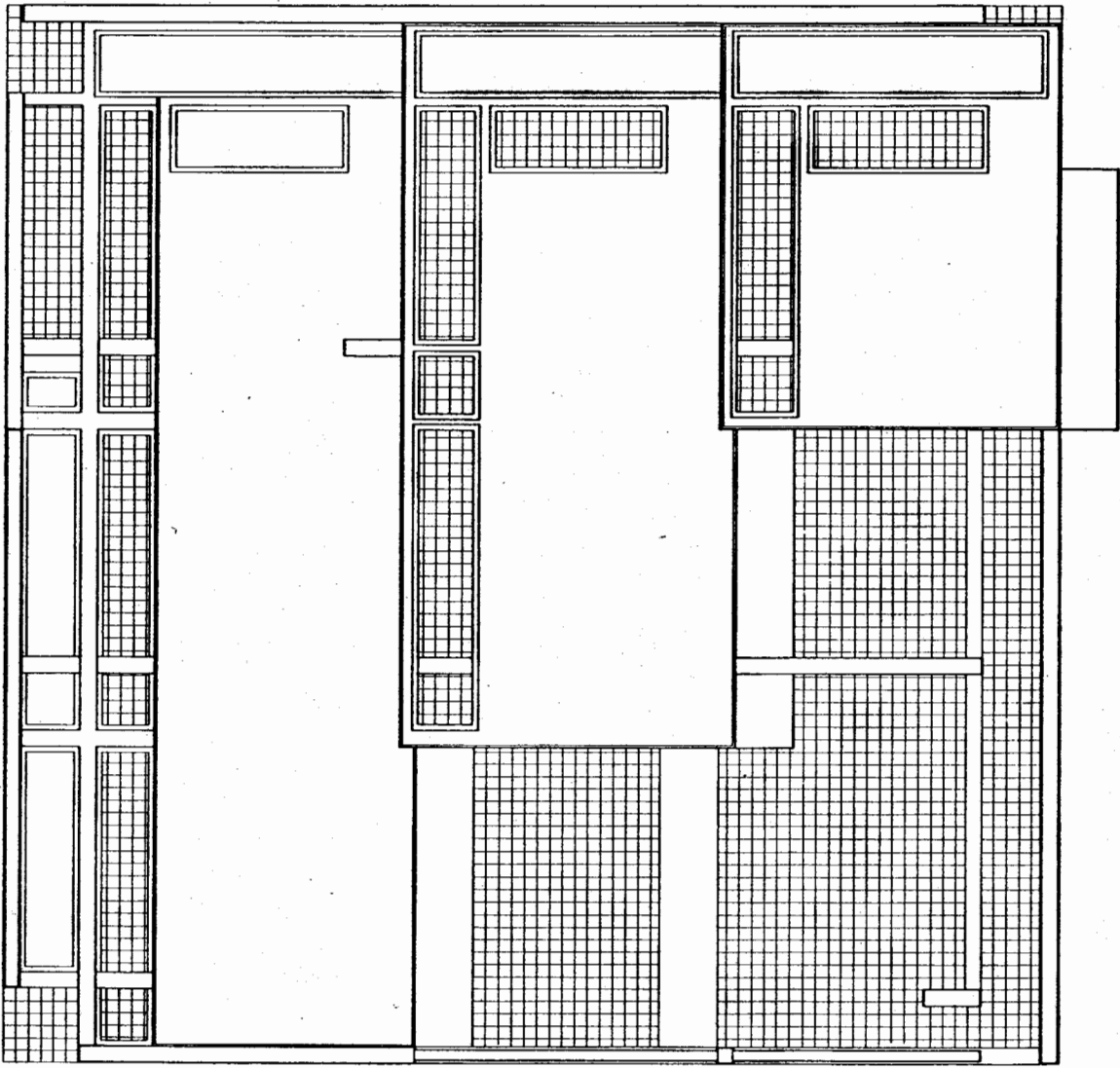

As with floor plans, whatever is cut through in taking a section (floors, walls, roof structure, etc.) is profiled with a heavy line. What lies behind the cut plane is seen in elevation.

Cut sections through major elements in a building (major window openings, doorways, changes in roof and floor levels, roof openings, fireplaces, etc.). Never cut through columns lest they read as walls!

It is a good practice to include people in building design sections to give scale to the spaces (see pages 90-92).

The physical context of the building should always be shown by indicating the earth upon which it sits, which is also cut through.

Construction details and foundations below grade (ground level) need not be indicated in design sections.

Building sections are normally drawn at  $\frac{1}{8}'' = 1'0$  or  $\frac{1}{4}'' = 1'0$ . For large buildings and complexes, the scale may be reduced to  $\frac{1}{16}'' = 1'0$  or smaller. Large scales ( $\frac{3}{8}'' = 1'0$ ) are used only for detail design sections.

↑ indicates direction of view  
 may be broken over a long distance  
 section indicator in plan

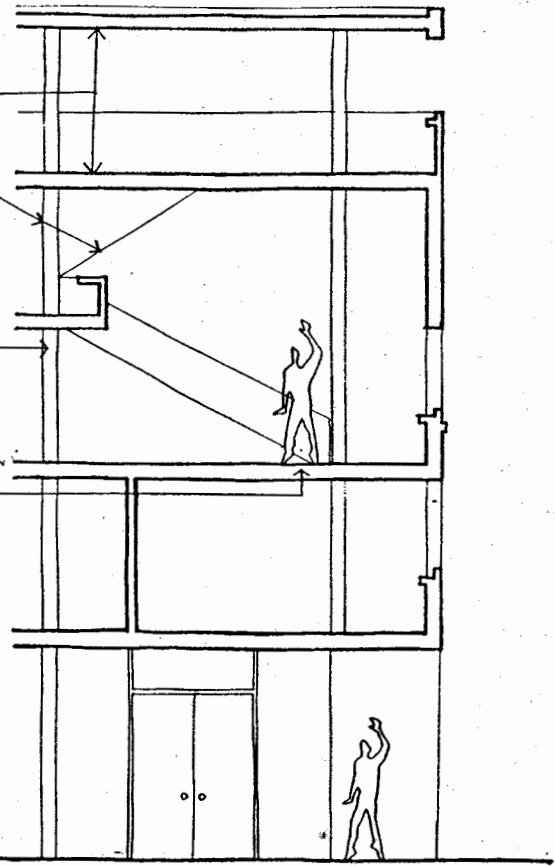

SITE SECTIONS

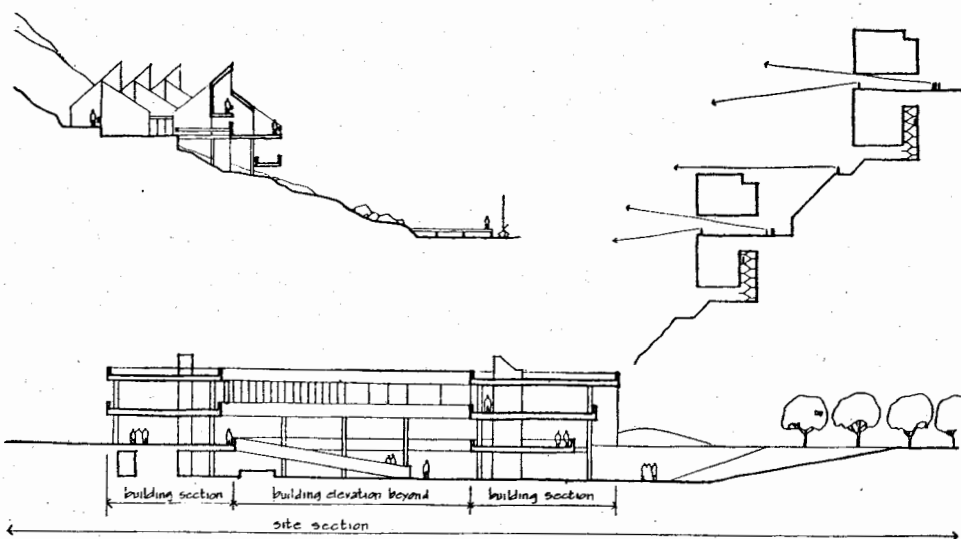

Site sections aid in illustrating the environment and physical context of a building, and the relationship between structures and the exterior spaces they define.

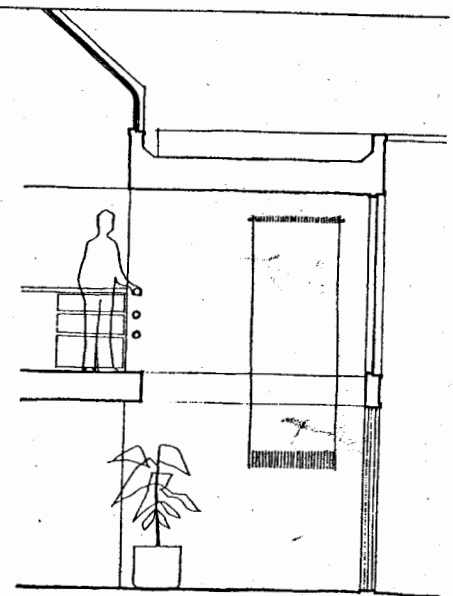

design section:  
 emphasis on form and definition of space

ELEMENTS ABOVE AND BELOW CUT

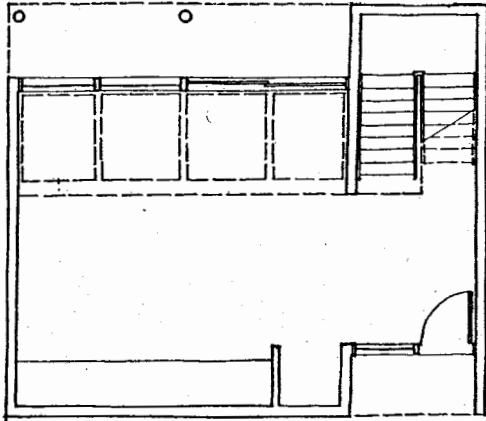

important elements above the horizontal cut (lofts, skylights, roof openings, lowered ceiling areas, roof overhangs, etc.) are indicated by long-dashed lines

elements below the floor line are indicated by short-dashed lines

to contrast with elements above the plan cut, but they are rarely shown

STAIRS

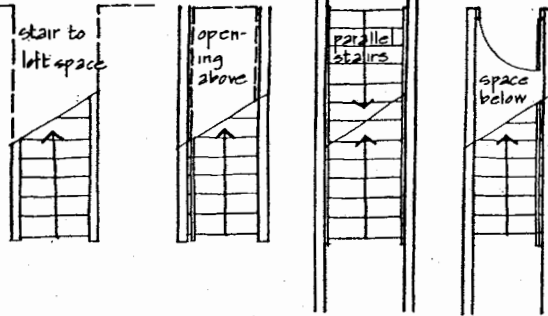

• show detail such as handrails and toe spaces where scale of drawing permits

• convention to indicate direction of stair: arrow indicates direction (up or down) from level of floor plan

• straight-run stairs

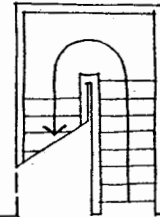

• U-type (return) stair

• spiral stair

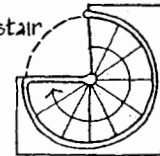

DOORS AND WINDOWS IN PLAN

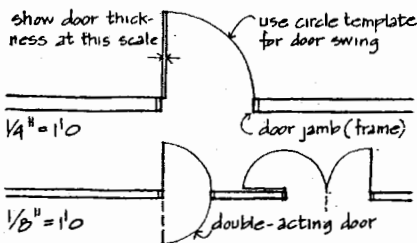

- show normally swinging doors at a 90° opening, as illustrated
- note that door swings are shown with light lines and quarter circles
- door type (solid wood, wood frame and glass, store front, etc.) is not illustrated in plan, only in elevational views

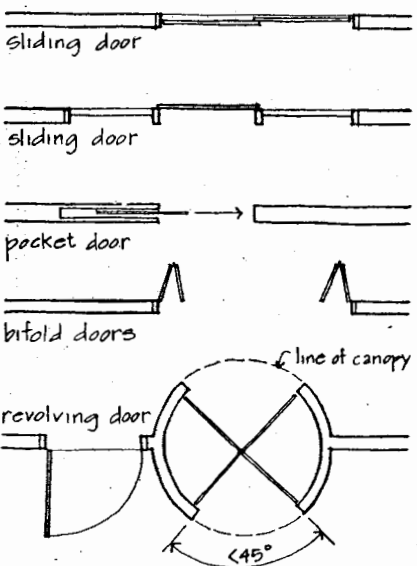

- window type (double-hung, casement, floor to ceiling, etc.) cannot be explained in plan except for width and location - window type and window height are shown in elevational views
- show sill lines with a lighter line weight than walls, jambs, and glass, since sills are not in fact cut through

